

# Digital Innovation Hub as Intermediary and Value Delivery System

---

Jurčić, Marina

Doctoral thesis / Disertacija

2023

Degree Grantor / Ustanova koja je dodijelila akademski / stručni stupanj: **University of Zagreb, Faculty of Organization and Informatics / Sveučilište u Zagrebu, Fakultet organizacije i informatike**

Permanent link / Trajna poveznica: <https://urn.nsk.hr/urn:nbn:hr:211:627428>

Rights / Prava: [In copyright](#) / [Zaštićeno autorskim pravom.](#)

Download date / Datum preuzimanja: **2024-07-24**



Repository / Repozitorij:

[Faculty of Organization and Informatics - Digital Repository](#)





University of Zagreb

Faculty of Organization and Informatics

Marina Jurčić

# **Digital Innovation Hub as Intermediary and Value Delivery System**

DOCTORAL DISSERTATION

Varaždin, 2023



University of Zagreb

Faculty of Organization and Informatics

Marina Jurčić

# **Digital Innovation Hub as Intermediary and Value Delivery System**

DOCTORAL DISSERTATION

Supervisor: Prof. dr. sc. Vjeran Strahonja

Varaždin, 2023



Sveučilište u Zagrebu

Fakultet organizacije i informatike

Marina Jurčić

# **Digitalno inovacijsko središte kao posrednik i sustav za isporuku vrijednosti**

DOKTORSKI RAD

Mentor: Prof. dr. sc. Vjeran Strahonja

Varaždin, 2023.

# DOCTORAL DISSERTATION INFORMATION

## I. AUTHOR

Name and surname	Marina Jurčić
Date and place of birth	8 February 1980, Požega, Croatia
Faculty name and graduation date for level VII/I	The Citadel, The Military College of South Carolina, bcc. comp. sci., USA (2003/2004)
Current employment	

## II. DOCTORAL DISSERTATION

Title	Digital Innovation Hub as Intermediary and Value Delivery System
Number of pages, figures, tables, appendixes, bibliographic information	410, 93, 35, 11, 371
Scientific area and fields in which the title has been awarded	Social Sciences, Information and Communication Sciences
Mentor and supervisor	Prof. dr. sc. Vjeran Strahonja
Faculty where the thesis was defended	Faculty of Organization and Informatics, University of Zagreb
Thesis mark and ordinal number	169

## III. GRADE AND DEFENCE

Date of doctoral thesis topic acceptance	25.10.2022.
Date of doctoral thesis submission	12.09.2023.
Date of doctoral thesis positive grade	14.09.2023.
Grading committee members	Assoc. Prof. Zlatko Stapić, Ph. D. Assoc. Prof. Martina Tomičić Furjan, Ph. D. Full Prof. Marite Kirikova, Ph. D.
Date of doctoral thesis defence	17.10.2023.
Defence committee members	Assoc. Prof. Zlatko Stapić, Ph. D. Assoc. Prof. Martina Tomičić Furjan, Ph. D. Full Prof. Marite Kirikova, Ph. D.
Date of promotion	

## MENTOR INFORMATION

Vjeran Strahonja is a full professor at the Faculty of Organization and Informatics University of Zagreb. He earned the title of Bachelor of Electrical Engineering (1980) and Master of Technical Sciences (1986) in the field of technical sciences, electrical engineering, at the Faculty of Electrical Engineering, University of Zagreb. Vjeran Strahonja defended his doctoral dissertation in the field of social sciences, information and communication sciences, in 1993, at the Faculty of Organization and Informatics University of Zagreb, with the topic "Conceptual modeling of the domain of information systems in the development cycle of software systems". He started his professional career as a research and development engineer, and has been working at FOI since 1986, first as a system engineer, then as a programmer and designer. Since 1988, he has been participating in research and teaching at FOI, in positions ranging from assistant (1988) to full professor in a permanent position (2014). Teaching and research disciplines are: System and Software Engineering, Production Information Systems, IT Service Management, Geoinformation Systems. He participated in a dozen domestic and international scientific projects. He is the author or co-author of more than 100 scientific and professional papers, as well as 5 books or monographs. He mentored 12 defended doctoral theses. As a leader or member of the project team, he participated in more than 60 professional and development projects. From 2007 to 2011, he was vice dean for operations at FOI, and in the period from 2011 to 2015, dean of the Faculty. Along with his academic career, Vjeran Strahonja was a director of an IT company for ten years. He led and participated in projects of strategic planning and building of complex information systems in different areas and participated in the creation of national strategies and regulations related to digital transformation. He actively participated in international project teams (World Bank, USAID, UNDP, NCSC ...) and in numerous national and European scientific and development projects.

## PREFACE

*There is no more appropriate place than the very beginning of the thesis, to express my sincere gratitude to all those who shared the burden with me through this academic journey.*

*I thank Interreg Europe staff and Aalto University, Espoo, Finland, for being kind enough to warmly welcome my uninvited presence at the Digital Innovation Hubs Workshop, and for giving me the chance to meet my future interviewees. My gratitude goes to all my interviewees, whose contribution to my thesis was priceless. Also, I am very grateful to professors Sandra Lovrenčić from the University of Zagreb, Faculty of Organization and Informatics, and Nataša Kurnoga from the University of Zagreb, Faculty of Economics and Business, for cowriting with me and helping me meet my publishing requirements. My gratitude also goes to professors Diana Šimić, Zlatko Stapić, and Martina Tomičić Furjan from the University of Zagreb, Faculty of Organization and Informatics, as well as professor Marite Kirikova from Riga Technical University, Latvia for all their patience through metamorphosis of my thesis.*

*Special thanks go to my PhD colleague Krunoslav Arbanas, who always had the energy, time, and patience to chase my doubts away. A big thank you goes to my colleague and friend Darko Možnik, without whose support and faith I would have never come this far academically, career wise, and life wise. I should also thank all the bosses throughout my professional career, with special emphasis on the bad ones, for making me push harder in an attempt to rise above.*

*Last but not least, my sincere gratitude goes to my mentor professor Vjeran Strahonja from the University of Zagreb, Faculty of Organization and Informatics, for his patience, perseverance, motivation, leadership, and unselfish knowledge sharing. Perhaps I will never be sure what in his eyes made me deserving of all the effort, but I am glad that something did and that he was a part of my journey.*

*As life happens in parallel, this thesis consumed a significant part of my time away from people in it, so I thank them all, even the passersby, for their patience. PhD tends to be more time and energy-consuming than initially appearing to most people, me being one of them. Therefore, my gratitude goes to all those who believed in me and encouraged me, especially during the times when I had doubts.*

*And most of all, for better or worse, I thank my family.*

## ABSTRACT

The subject of this thesis is research on Digital Innovation Hubs (DIHs), as systems for value delivery and primarily as intermediaries in processes of knowledge and technology transfer from the research community to industry and vice versa. These processes are crucial for business digital transformation, and much needed for market competitiveness. For research of DIHs and alike concepts, scientific literature will be used, but also policy documents, strategies, project solutions, etc. European DIHs (EDIHs), as special kinds of DIHs, will also be elaborated upon. In the research, the metamodeling method for value delivery systems will be used, especially for DIHs, to create DIH generic metamodel, whose purpose is establishing a level of conformance of different phenomena and concepts with DIH, information systems design, evaluation of policies and strategies, etc. Verification of generic DIH metamodel will be conducted through in-depth interviews with subject matter experts and validated with a focus group.

**Keywords:** Digital Innovation Hub, Digital Transformation, Value Delivery System, Value Delivery Modeling Language (VDML), Metamodeling, Conceptual Mapping, Knowledge Transfer, Technology Transfer, Intermediaries



## PROŠIRENI SAŽETAK

Brojni znanstveni članci razmatraju probleme posrednika u procesima prijenosa znanja (Knowledge Transfer, KT) i prijenosa tehnologija (Technology Transfer, TT) od akademske zajednice do industrije i obrnuto, koji imaju ulogu katalizatora [1] i koji zahtjevaju bolju razradu. Oni usklađuju potrebe industrije kroz KT i povezuju financijske izvore [2] te doprinose razvoju povjerenja i unapređuju prepoznavanja partnera [3]. Preliminarno istraživanje u znanstvenoj literaturi je prepoznalo oko pedeset problema vezanih za posrednike. Oni uključuju društvenu odgovornost, posrednike, ulogu brokera, uparivanje potencijalnih partnera za kolaboraciju [4], kao i poslovni model posrednika, izbor kanala i internu strukturu za optimalan odgovor [5].

Među tim posrednicima su i DIH-ovi. Prvi puta su predstavljani 2016. godine u strategiji „Digitalizing European Industry Strategy“ Europske komisije (European Commission, EC) [6], kao strukture čija je glavna svrha digitalna transformacija (Digital Transformation, DT) malih i srednjih poduzeća (small and medium-sized enterprises, SMEs) [7]. Oni su neprofitne "one-stop-shops" strukture s organizacijom za istraživanje i razvoj ili sveučilišnim laboratorijem u svojoj srži [8]. Budući da SME nose 99% cjelokupnog poslovanja Europske Unije (EU) [9] te činjenice da je razina digitalizacije EU država članica vrlo heterogena, DIH-ovi su stvoreni kako bi unaprijedili EU konkurentnost na internacionalnom tržištu kroz digitalizaciju četiri petine EU SME, koji još nisu visoko digitalizirani [10]. DIH-ovi okupljaju različite dionike, a kroz politike država članica i regija, industrije (s naglaskom na SME), istraživačke entitete i akademsku zajednicu - stvaraju sinergiju [7]. Kriteriji za DIH elemente još nisu propisani [11] i zahtjevaju daljnju razradu.

Osnovna pretpostavka ovog istraživanja je da je DIH u svojoj osnovi sustav za isporuku vrijednosti (Value Delivery System, VDS). Vrijednost koja se isporučuje DIH korisnicima, koji su prvenstveno SME i javnih sektor, su umrežavanje, razni oblici dijeljenja poslovnih savjeta, korištenje KT platformi i usluga i dr. Govoreći kibernetičkim rječnikom, DIH je

upravljani sustav koji posreduje u transformaciji znanja i vještina od pružatelja od korisnika, dok se uloge u procesu mogu izmjenjivati. Studije slučaja će biti korištene za prikaz i evaluaciju pojedinih scenarija DIH isporuke vrijednost. U skladu s navedenim, metamodeliranje će biti korišteno za stvaranje dizajna DIH referentnog meta-metamodela (DIH Referent Meta-Metamodel, DIH RMM). Value Delivery Modeling Language (VDML) metamodel će biti korišten kao početna točka za DIH RMM dizajn. DIH RMM bi bio koncept, koji bi mogao generirati nove DIH modele. DIH karakteristike koje ga čine prikladnim za modele za isporuku vrijednosti (Value Delivery, VD) su njegove strukture i odnosi koji mogu biti mapirani na podskup VDML metamodela; klase koje je definirala Object Management Group (OMG) [12].

Fokus VDML-a su aktivnosti, sposobnosti, poslovne mreže, lanci vrijednosti, uloge i kompleksne kolaboracije [12], a to su sve elementi DIH-a i mogu na razne načine biti prepoznati u DIH literaturi. Moguće je istražiti konformnost koncepata DIH-a s konceptima VDS-a. Stoga, kako bi bilo prikazano stvaranje i razmjena vrijednosti, modeliranje vrijednosti bi bio koristan pristup [13].

Postoje brojne metode, referentne arhitekture i alati za modeliranje vrijednosti, koji će obogatiti DIH RMM. e3value metoda se koristi za modeliranje razmjene vrijednosnih objekata između mreža klijenata i organizacija, gdje svaka stranka uključena u transakciju zaprima barem jedan vrijednosni objekt; ekonomsku transakciju [14]. Resource-Event-Agent (REA) ontologija, za razliku od e3value metode, ne sadrži element aktivnosti vrijednosti i nije najbolji pristup za razvoj poslovanja [15]. Alexander Osterwalderovo i Yves Pigneurovo Platno poslovnog modela (Business Model Canvas, BMC) je najpopularniji alat za razvijanje modela i vizualizaciju, koji se temelji na Business Model Ontology (BMO) [16]. TOGAF® standard od The Open Group za Enterprise Architecture Methodology i okvir za poboljšanje poslovne efikasnosti, uključuje sadržajni okvir koji osigurava dosljednost vezanu za ishode Architecture Development Method (ADM) [17]. Lindgrenov poslovni model ima sedam dimenzija: prijedlog vrijednosti (Value Proposition), klijent i/ili korisnik (Customers and/or User), unutarnje funkcije lanca vrijednosti (Value Chain Functions (Internal Part), kompetencije

(Competences), mreža (Network), odnos (Relation) i formula za vrijednost (Value Formula) [18]. Ovaj model je rezultat potrebe za zajedničkim jezikom za modeliranje poslovanja i generički okvir za bilo koji poslovni model [18]. Value Network Analysis (VNA) definira različite uloge u kolaboraciji i stvaranje vrijednosti kroz razmjenu s ciljem: utjecaja na (ne)financijske izvore; otkrivanja novih vrijednosti; povećanja isporuke vrijednosti i njihova optimizacija; poboljšanja organizacijske, operativne i financijske izvedbe; te unapređenja vrijednosnih tokova [19].

**Prvo poglavlje** je uvertira u disertaciju, koja objašnjava zašto su DIH-ovi odabrani kao glavni protagonisti. Poglavlje također objašnjava motivaciju za istraživanje, glavne ciljeve i hipoteze, zašto je istraživački okvir znanosti o dizajnu odabran za istraživačku metodologiju te koji su znanstveni i društveni doprinosi istraživanja.

**Drugo poglavlje** objašnjava kako će istraživanje biti izvedeno kroz faze istraživačkog okvira znanosti o dizajnu (Design Science Research, DSR); prva faza je zaokupljena kvalitativnim istraživanjem kroz pregled literature; druga faza se tiče hipoteze da je poslovni model DIH-a u svojoj srži isporuka vrijednosti, pa će DIH biti mapiran na VDML metamodel; u trećoj fazi će biti kreirani artefakti, biti će napravljeno konceptualno mapiranje, kao i instrument. Četvrta i peta faza će biti razrađene u šestom poglavlju.

**Treće poglavlje** daje prikaz rezultata pregleda literature koji je napravljen za ovu disertaciju. Znanstvena osnova disertacije je znanstvena teorija u području prijenosa znanja i tehnologije, od akademske zajednice do industrije i obrnuto. U području prijenosa znanja i tehnologija, fokus disertacije se sužava na posrednike u tim procesima. Među različitim posrednicima, fokus se dalje sužava na DIH-ove. Opisani su i problem posrednika.

**Četvrto poglavlje** objašnjava hipotezu da je poslovni model DIH-a u svojoj srži model sustava za isporuku vrijednosti. Vrijednost mora biti adekvatno prikazana, a to se može postići na razne načine. Ovo poglavlje pruža definicije osnovnih povezanih koncepata, objašnjenja, opise i usporedbe, kao i objašnjenje zašto će metamodeli biti korišteni u ovoj disertaciji, a ne ontologije. Također će biti dan prikaz DIH (meta)modela.

**Peto poglavlje** opisuje druge referentne arhitekture, koje pružaju različite poglede na DIH, fokusirajući se pritom na njegove razne aspekte. One su Osterwalderovo platno poslovnog

modela, TOGAF, REA, e3value i Lindgrenov poslovni model. DIH elementi u njihovoj potpori će biti određeni. Također, inicijalne M0, M1/1 i M1/2 konceptualne razine DIH-a su prikazane.

**Šesto poglavlje** razrađuje četvrtu fazu DSR-a; u četvrtoj fazi će biti napravljena evaluacija kroz verifikaciju i validaciju.

**Sedmo poglavlje** razrađuje petu fazu DSR-a; biti će doneseni zaključci, prijedlog RMM DIH-a će biti dizajniran te će biti određen stupanj komplementarnosti i nekompatibilnosti DIH-a s VDML metamodelom.

**Osmo poglavlje** elaborira zaključke disertacije. Također opisuje znanstvene i društvenedoprinosne disertacije, ograničenja istraživanja i implikacije na buduća istraživanja.

**Deveto poglavlje** se sastoji od referenci. Ono je prikaz literature koja je korištena za disertaciju.

**Deseto poglavlje** se sastoji od pravitaka, koji sadrže razne popise i tablice povezane s disertacijom, kao i instrumente te bilješke s praktičnog dijela istraživanja.

**Ključne riječi:** Digitalna inovacijska središta, Digitalna transformacija, Metamodeliranje, Sustav za isporuku vrijednosti, Value Delivery Modeling Language (VDML), Konceptualno mapiranje, prijenos znanja, prijenos tehnologije, posrednici

## TABLE OF CONTENTS

1. INTRODUCTION .....	1
1.1. Research Topic .....	1
1.2. Research Objectives and Hypotheses .....	3
1.3. Scientific and Societal Contributions .....	4
1.4. Chapter Conclusions .....	5
2. RESEARCH METHODOLOGY .....	5
2.1. Design Science Research .....	6
2.2. First Phase Description: Awareness of the Problem.....	7
2.3. Second Phase Description: Suggestion.....	8
2.4. Third Phase Description: Development.....	11
2.4.1. Conceptual Mapping .....	13
2.4.2. The Instrument.....	16
2.5. Fourth Phase Description: Evaluation .....	17
2.6. Fifth Phase Description: Conclusions.....	18
2.7. Chapter conclusions.....	18
3. FIRST PHASE EXECUTION: GENERAL THEORY .....	20
3.1. Knowledge Transfer from Research Community to Industry and Vice Versa .....	21
3.1.1. Networking .....	21
3.1.2. Social capital .....	24
3.1.3. The Helices .....	26
3.1.4. Patents and Intellectual Property Matters .....	28
3.1.5. Intermediaries .....	29
3.1.6. Digital Innovation Hubs .....	31
3.1.7. European Digital Innovation Hubs .....	34

3.1.8. Problems of Intermediaries.....	35
3.1.9. Other general matters .....	37
3.2. Technology Transfer from Research Community to Industry and Vice Versa.....	41
3.2.1. Commercialization .....	42
3.2.2. Funding.....	44
3.2.3. Innovation.....	45
3.2.4. Intermediaries .....	47
3.2.5. Models .....	48
3.2.6. Patents.....	51
3.2.7. Policy .....	53
3.2.8. Social factors .....	54
3.2.9. Spin - offs and Start - ups .....	55
3.2.10. University - Industry Collaboration.....	57
3.2.11. Other Technology Transfer Matters .....	58
3.3. Chapter Conclusions.....	59
<b>4. SECOND PHASE EXECUTION: VALUE REPRESENTATION AND PROPOSED DIH REPRESENTATION MODELS .....</b>	<b>62</b>
4.1. Basic Concept Definitions.....	62
4.2. Concept of Value .....	65
4.3. Value Methods and Methodologies .....	67
4.4. Value Ontologies .....	69
4.5. Other Value Associated Matters .....	71
<b>5. THIRD PHASE EXECUTION: ANALYZING DIH’S BUSINESS MODEL WITH VDML AND DIH REPRESENTATION .....</b>	<b>75</b>
5.1. Different Cognitive Levels of DIH Model Representation .....	76
5.1.1.M0 Cognitive Level of DIH Model Representation.....	76

5.1.2.M1/1 Cognitive Level of DIH Model Representation.....	79
5.1.3.M1/2 Cognitive Level of DIH Model Representation.....	83
5.2. DIH Alignment with Other Referent Architectures.....	99
5.2.1. Osterwalder’s Business Model Canvas .....	99
5.2.2. DIH Elements Supporting Value Creation and Osterwalder’s BMC .....	100
5.2.3. Osterwalder’s BMC Model and Metamodel .....	100
5.2.4. Value Network Analysis.....	107
5.2.5. VDML DIH Concepts Mapped onto VNA .....	108
5.2.6. VNA Model .....	109
5.2.7. TOGAF.....	111
5.2.8. TOGAF Metamodel.....	112
5.2.9. TOGAF and DIH Value Streams .....	118
5.2.10. Resource- Event- Agent .....	139
5.2.11. REA Model and Metamodel.....	139
5.2.12. e <sup>3</sup> value .....	144
5.2.13. e3value Model and Metamodel .....	144
5.2.14. VDML Concepts Mapping onto e3value Concepts.....	148
5.2.15. Lindgren’s Business Model Cube .....	149
5.2.16. Lindgren’s Business Model Cube Model.....	150
5.3. Chapter Conclusions .....	153
6. FOURTH PHASE EXECUTION: VERIFICATION AND VALIDATION .....	155
6.1. Verification .....	155
6.2. Validation .....	190
6.3. Chapter conclusions.....	194
7. FIFTH PHASE EXECUTION: DISCUSSION OF RESULTS.....	194

7.1. Main Objective No1 .....	194
7.2. Main Objective No2 .....	203
7.3. Main Objective No3 .....	207
7.4. Main Objective No4 .....	222
7.5. Main Objective No5 .....	229
7.6. Main Hypothesis No1 .....	229
7.7. Main Hypothesis No2 .....	230
7.8. Chapter Conclusions .....	230
8. CONCLUSIONS .....	232
8.1. UML, VDML and MOF .....	232
8.2. Contributions .....	233
8.3. Scientific Foundation .....	233
8.4. Value and Value Delivery .....	235
8.5. Design Science Research Framework .....	237
8.6. Research Objectives and Hypotheses Revisited .....	239
8.7. Limitations and Further Study Suggestions .....	240
9. REFERENCES .....	242
10. APPENDIX .....	271
Appendix 1: List of Abbreviations .....	271
Appendix 2: List of Tables .....	276
Appendix 3: Tables .....	278
Appendix 4: List of Figures .....	306
Appendix 5: Invitation Letter and Presentation for the Practical Part of the Research .....	311
Appendix 6: List of Literature Used for Preliminary DIH VDML (Meta)Model Representation (and Conceptual Mapping) .....	314



Appendix 7: Instruments for Semi-Structured In-Depth Interviews with DIH Experts.....	315
Appendix 8: Notes from the Interviewing Process.....	324
Appendix 9: Interviewee Information .....	402
Appendix 10: Notes Taken During Focus Group Interviewing Process .....	404
Appendix 11: Focus Group Member Information.....	408
CURRICULUM VITAE .....	409

## 1. INTRODUCTION

This introductory chapter, explains why Digital Innovation Hub (DIH) was chosen as the main subject of the research. European Commission's (EC) DIHs have become important actors in business digitalization, as well as the associated knowledge transfer (KT) and Value Delivery (VD), which is what makes DIH an interesting organizational structure for in-depth scientific study. DIH research can be performed in numerous ways; from knowledge management aspect, economical aspect, social aspect, but most of all from aspect that it is a novel, structural, functional and organizational VD structure. In regards to that, this chapter explains relevant elements pertaining to the research topic. Also, research objectives and hypotheses which will be in focus of the thesis will be given, because they will be further elaborated upon throughout the entire thesis. Scientific and societal contributions of the thesis will also be explained, as the main contributions of this comprehensive research.

### 1.1. Research Topic

The focus of this subchapter is the explanation of the thesis research topic; motivation for it, field and area of research, as should always be explained at the very beginning of every scientific research.

It is important to note that many scientific articles discuss problems of intermediaries in the processes KT from research community to industry and vice versa, which serve as catalysts [1], and which require better insight. Amongst those intermediaries are also DIHs, non-profit "one-stop-shops" with research & technology (R&T) organization or university lab at core, in function of small and medium-sized enterprises' (SMEs), public sectors', and mid-caps' digital transformation [8]. SMEs comprise 99.8% of European Union (EU) companies, 70% of available workforce and contribute to cca 60% Gross Domestic Product (GDP) [20, p. 1]. DIH is an organizational structure introduced in order for Digital Transformation (DT) to become possible and widely applicable. Yet, it remains to be unknown what should DIH be composed of. DIH in its essence is a Value Delivery System (VDS), value being knowledge and skills transferred to its customers seeking help with digitalizing their businesses. In that regard, Value Delivery Modeling

Language (VDML) and metamodeling could be used in order to create DIH referent metamodel (DIH RMM) proposal design.

The **motivation** for this research is the potential of DIHs in the area of digitalization, KT, and VD, while having an immense impact on European economy. Motivation also comes from recognized search for a way to make KT from research community to industry and vice versa more efficient [21], and the problems in areas where the basic business model and added value lies in mediation [22], which requires service redesign, business process redesign and which therefore requires scientific theory and methodology. To further contribute to justification of motivation, it should be added that EU Member States aspire to stay competitive on global market, and for that to be accomplished, they are also trying to raise their digitalization level [23], for which effective KT is crucial [24] [25]. One of the causes of KT process issues worth mentioning is also the fact that the industry wants the results immediately in order to stay competitive [26], whilst research community works slowly and scientifically. This issue, and also the fact that EU is the contributor of one fifth of the highly cited scientific publications in the world but it is falling behind United States of America (USA) and Japan with innovation output [27], also stresses the importance of proper mediators between stakeholders.

In that context, the **field** of this research is determining elements of DIHs as intermediaries in processes of KT. It is also the methodology of describing, establishing and viewing DIHs as VDS through VDML metamodeling.

The **area** of this research is the design of generic DIH model (DIH RMM), which will serve as a benchmark for other DIHs, DIH comparison, improvement of DIH interoperability and structuring of DIH catalogue.

The conclusion of this subchapter is the following: the motivation for this research is the potential of DIHs in the area of digitalization, KT, and VD, having a strong impact on European economy; field of this research is determining elements of DIHs as intermediaries in processes of KT, methodology of describing, establishing and viewing DIHs as VDS through VDML metamodeling;

and the area of this research is design of DIH RMM, which will serve as a benchmark for other DIHs, DIH comparison, improvement of DIH interoperability and structuring of DIH catalogue.

## 1.2. Research Objectives and Hypotheses

Main objectives were derived from the recognized problem. They are explained in this subchapter, as well as two main hypotheses of the research, as the very foundation of the thesis.

The **main objectives** of this research are the following:

- 1) Identification of factors which influence intermediaries in VD from research community to industry and vice versa;
- 2) Identification of DIH similarities and specifics in comparison to other intermediaries;
- 3) Design of DIH VDML metamodel, as a model of DIH value creation;
- 4) Establishing the degree of conformance of DIH with VDML metamodel; and
- 5) Design of DIH RMM.

**Main hypotheses** of the research are:

H1: In accordance with relevant theories of value delivery, Digital Innovation Hub is a Value Delivery System.

H2: Digital Innovation Hub Referent Meta-Metamodel is an adequate instrument for determining conformance of referent architectures which contain concepts of Value Delivery.

In conclusion of this subchapter, it can be said that it provides main objectives and main hypothesis of the research.

### 1.3. Scientific and Societal Contributions

In accordance with the scientific practice, PhD thesis have to ensure scientific and societal contributions, as well as the contribution to the field of science of the research. Those contributions are elaborated upon in this subchapter.

The expected **scientific contributions** of this research are:

- a) The methodology; proposed design of VDML DIH metamodel as of a value-producing system, as well as proposed design of DIH RMM, and
- b) The scientifically established facts regarding KT between research community and industry, as well as increased knowledge regarding DIHs.

**Contribution to Information and Communication Sciences** is contained in the very essence of DIH, as an organizational unit acting as a KT catalyst, with technology in its background, and addressing issues of digitalization.

**Societal contribution** will be practical use of the proposed VDML DIH metamodel as a conceptual framework for DIH modeling, and DIH RMM, which as a part of a wider framework could be used for DIH benchmarking, comparison of DIHs, as a reference point providing guidance for what a DIH should be comprised of, design of information systems with compatible semantics, and also for structuring of DIH catalogue.

This subchapter displayed and explained what the two expected scientific contributions of this research are, what is the contribution to Information and Communication Sciences, and what the societal contributions are.

## 1.4. Chapter Conclusions

This introductory chapter is an overture into the thesis, explaining why DIH was chosen as the main protagonist. As a prelude, the chapter also explains the motivation for this research, research objectives and hypotheses, and what the scientific and societal contributions are.

The motivation for this research is the potential of DIHs in the area of digitalization, KT, and VD, having a strong impact on European economy; field of this research is determining elements of DIHs as intermediaries in processes of KT, methodology of describing, establishing and viewing DIHs as VDS through VDML metamodeling; and the area of this research is design of DIH RMM, which will serve as a benchmark for other DIHs, DIH comparison, improvement of DIH interoperability and structuring of DIH catalogue.

The chapter explains objectives and hypotheses of the research. Also, this chapter displayed and explained what the two expected scientific contributions of this research are, what is the contribution to Information and Communication Sciences, and what the societal contributions are.

## 2. RESEARCH METHODOLOGY

This chapter explains which methodology was chosen for the research. As research approach for the research in this thesis, Design Science Research (DSR) framework was chosen. The reasons why, and the phases in which research will be conducted are explained in this chapter. It is important to do so because this framework will be the main path followed throughout the entire thesis. Also, explanation for the use of some other scientific methods and tools used in the research will be provided in this chapter.

## 2.1. Design Science Research

DSR is often used in research in the area of information systems because it produces novel artefacts, in order to solve real-world complex problems and also to generate design knowledge [28, pp. 1-2]. Engineering disciplines also teach how to design and create artefacts with adequate attributions, and it is difficult to derive scientific knowledge from engineering processes which were not designed through a DSR approach, which also aids with countering KT and knowledge adoption limitations in engineering digital innovations [29, p. 2]. DSR also allows systematic creation and classification of different innovative artifacts related to Information Systems (IS), cumulation of DSR knowledge allowing for description, reuse and comparison of artifacts, as well as creation, transfer, and generalization of IS artifact design [29, p. 1]. It creates innovative artefacts which improve their environment and solve problems, resulting in new artefacts and design knowledge (DK) [30, p. 1]. Hevner et al. give seven guidelines:

DSR creates purposeful and innovative artefact for a certain problem domain and for solving so far unsolved problem or providing a more efficient/effective solution; artefact has to be evaluated, defined with rigor, coherent, formally represented, internally consistent; problem space is created, with existing mechanism for solution search; the result must be effectively communicated to practitioners, managerial staff, and technical audience [31, p. 82].

DSR has a great potential for solving societal and economic problems [32, p. 1]. All these DSR information contributes to the explanation why it was deemed an appropriate approach for this thesis.

The research will be performed in five phases, following the phases of design science research framework: Awareness of the Problem, Suggestion, Development, Evaluation and Conclusions [33]. A number of different scientific methods will be used: literature review; conceptual mapping; modeling of different aspects at different abstraction levels; (meta)modeling, mapping onto other methodologies; in-depth interview; and focus group. Scientific literature review will be performed in other to create scientific basis for the thesis. It will be additionally supplemented with expert literature, mostly on the topics for which scientific literature is scarce. In this thesis, 371 pieces of literature were cited. Conceptual mapping will be performed in order to map real life concepts onto computer language concepts and other methodologies. (Meta)modeling will be used in order to

depict different instances of a system on different levels of abstraction. Mapping onto other akin methodologies will be performed in order to prove that it is possible and also to elaborate in further detail some VD aspects of DIH. In-depth interviews will be conducted with different experts and authorities needed for verification of a model and also gathering additional information not available in literature. Finally, a focus group will be used for validation of the final product of the research.

This subchapter gave a brief explanation of why DSR was deemed the best approach for this thesis. Also, other scientific methods which will be used were listed, and explanation for their use was provided: scientific and expert literature review, conceptual mapping, (meta)modeling; mapping onto other methodologies, in-depth interview, and a focus group. In this thesis, 371 pieces of literature were cited. Those pieces of literature are cited in References chapter.

## 2.2. First Phase Description: Awareness of the Problem

Qualitative research has been conducted through literature review, which enabled establishment of the wider research context. Scientific database Web of Science Core Collection was searched first in order to find scientific articles regarding KT from research community to industry, by using the following query: TS=(("knowledge transfer\*") AND ("research") AND ("industry")). Following that, scientific database Scopus was searched by using the following query TITLE-ABS-KEY (("knowledge transfer\*") AND ("research") AND ("industry")) AND (LIMIT-TO (ACCESSTYPE(OA))). Both of those queries initially yielded with over 1000 articles. After eliminating double entries and articles in languages other than Croatian and English, after choosing potentially relevant articles and completing the additional research with relevant articles from databases Science Direct and Google Scholar, around 250 articles were selected for further reading. Articles mentioning intermediaries' problems were read first, resulting with the list of over fifty recognized factors, which were then grouped in three main fields.

The results of the first DSR phase, are described in chapter 3. This subchapter explained how the first phase of DSR will be completed through literature review, as qualitative part of this research.



### 2.3. Second Phase Description: Suggestion<sup>1</sup>

One of the hypotheses of this research is that in accordance with relevant theories of VD, DIH is a VDS. Conformance of DIH concepts will be confirmed through value delivery system concepts. So, a DIH as a VDS will be mapped onto a VDML metamodel, for DIH RMM suitability to be further explored. VDS strives to deliver the largest possible amount of value to its customers and create profit for process participants [34, p. 29].

Object Management Group (OMG) publishes various different specifications for different applications intended for implementing Model Driven Architecture (MDA), and one of those specifications is also for Unified Modeling Language (UML) [35]. Besides that, OMG also published specification for VDML, managerial staff being the target audience, aim being the business design models which connect corporate business' operational and strategic level, and purpose being the enhancement of business transformation common understanding [36]. VDML puts a focus on business networks, activities, roles, value chain, capabilities and complex collaborations [19]. The purpose of Value modeling is depiction of exchange and creation of values [37]. OMG also published modeling and metadata specification named Meta Object Facility (MOF), which belongs to MDA language family, ensuring framework for platform-independent and open management, allowing interoperability and creation of systems which handle metadata and models [38]. MOF specification makes possible for models to be retrieved, transported between applications, transformed into different formats, stored, and used for application code creation [39]. Metamodel is utilized for modeling arbitrary metadata and models, and in its essence is a model of the model with min two layers of abstraction called metalevels [38].

Fig. 1. shows the first part of the DIH RMM design methodology. It shows that Object of Modeling is represented as UML Model and that it is conformant with UML Metamodel, which is providing additional specification. UML Metamodel is conformant with MOF, which is a meta-metamodel and which provides metamodeling rules. The object of this modeling is a DIH system, DIH model

---

<sup>1</sup> From the article written by Jurčić and Strahonja [40].

is depicted as a UML model, and it is conformant with DIH RMM. This methodology displayed on Fig. 1. below is based on [40] in a way that DIH model is on M1/1 conceptual level and DIH RMM is on M1/2 conceptual level; both model and metamodel are on M1 conceptual level, residing on different layers, because that is the conceptual level of reality on which VDML resides.

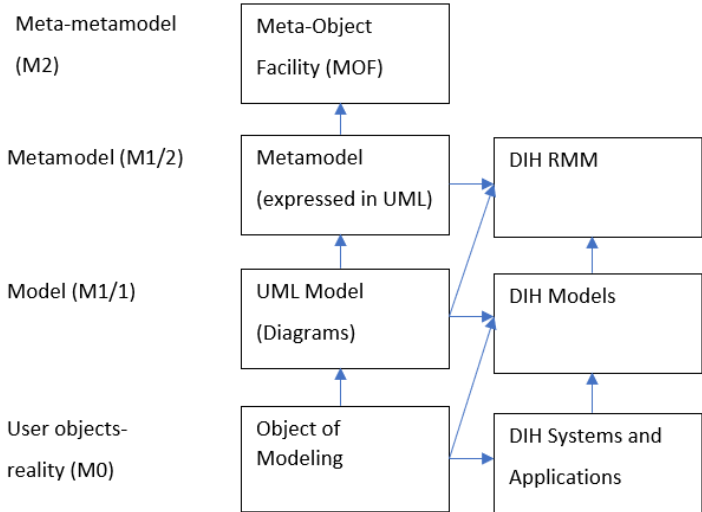

Fig. 1. DIH-UML-MOF Methodology Explanation.

Fig. 2. shows further steps of this methodology of DIH RMM creation, based on [40]. Metamodeling is further extended by VDML profile, which is a UML profile used for VDS. Object of Modeling is VDS, UML profiled model is VDS Model (VDSM) and it is conformant with VDML, which is a Metamodel of VDSM representing a VDS.

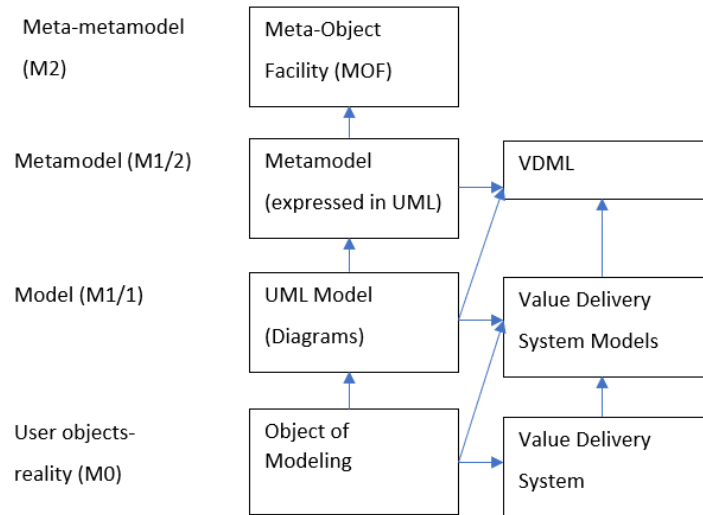

Fig. 2. VDM Profile Extended Metamodeling Methodology Explanation.

Fig. 3. shows the complete methodology, based on [40]. DIH RMM is one of the scientific contributions of this thesis. The value of DIH RMM lies in the possibility of usage for comparison of DIHs, DIH benchmarking, as a reference point for guidance showing what a DIH should be composed of, and for DIH catalogue structuring.

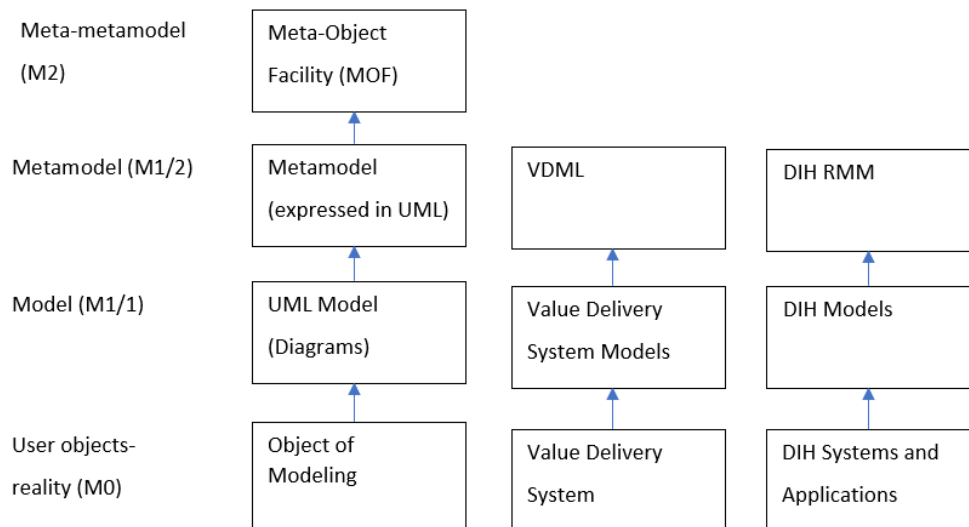

Fig. 3. DIH RMM Creation Methodology Explanation.

This thesis' research is founded on the hypothesis that DIH's business model is a value delivery, and that will be proven through conformance of the generic DIH model (DIH RMM) with VDML specification-based VD metamodel. In this thesis **Conformance Analysis** will be conducted at VDML Collaboration Modeling Conformance level. That says that VDML metamodel subset is usable for organization's relationships and structures, and it is conformant if XMI can be exported and imported in consistency with VDML Metamodel Conformance (Subclause 2.2) and Structured Metrics Metamodel, while also implementing these classes: 'Actor', 'Participant', 'Person', 'Attributes', 'Annotation', 'Role', 'RoleDefinition', 'RoleCategory', 'RoleLibrary', 'MeasurableElement', 'VdmlElement', 'ValueDeliveryModel', 'MeasuredCharacteristic', 'OrgUnit', 'Assignment', 'Position', 'Collaboration', 'Community', 'PortContainer', 'Member', 'Party', and 'BusinessNetwork' [19]. According to OMG, conformance level described above belongs to VDML Metamodel Conformance subset (Sub-clause 2.2), not conforming to notation of VDML (Sub-clause 8) [19]. Value and Value Proposition classes are important for this research as well, considering the usefulness of the Value Delivery Modeling by Business Enterprise Engineering (VDMbee) platform methods and different value-based approaches, like Osterwalder's Business Model Canvas (BMC) [41], all explained in detail in chapter 5.3.1.

This subchapter explains the second DSR phase. It explains the proposed DIH- UML-MOF methodology and VDML profile extended metamodeling, all as a part of DIH RMM creation methodology. It also explains how Conformance Analysis will be conducted at VDML Collaboration Modeling Conformance level.

#### 2.4. Third Phase Description: Development

In the third phase – Development, artifacts will be created. For that, conceptual mapping method will be used. Also, the instrument will be created, as a tool for the in-depth interview method. This subchapter therefore describes details regarding conceptual mapping and the instrument.

It is important to clarify the similarities and differences of conceptual mapping and metamodeling terms and methods, especially when UML is being used for metamodeling. These are two different methods used in the area of knowledge display and information management. Conceptual mapping is a method which consists of various visual techniques for display of knowledge granules or

concepts, in form of a mind map or a diagram, showing relationships between different ideas, concepts or elements in certain area, whilst enabling understanding of structures, relationships and dependencies of different system or area components. It integrates different methods qualitative and quantitative in nature, helping a number of individuals with articulation and graphic representation of model or coherent conceptual framework [42, p. 166]. In concept maps, concepts are hierarchically represented in a way that the most general concept is at the very top of the concept map, whilst less general concepts of the concept map are arranged below hierarchical manner [43, p. 1]. It also represents relationships between different concepts [44, p. 27].

In this thesis, metamodeling is also conceptual mapping for at least three reasons: abstraction, visualization and analytical orientation. Both methods use abstraction for simplification of complex structures for the ease of understanding. They both use visualization in terms of visual diagrams or models for display of information and relationships, where UML class diagrams are more strict structures with its notation, semantics and limitation. They are also both analytical methods which enhance understanding, behavior and relationships of elements within the system.

There are also some differences between the two terms and methods, especially when UML class diagrams are being used for metamodeling. Those differences are in the area of the purpose and use, scope and the level of abstraction. When it comes to purpose and use, conceptual mapping is focused on representing (organizing and visualizing) different relationships between concepts, knowledge granules etc., in areas of education, psychology and information management. It is used for brainstorming in management and early phases of knowledge management system development. Metamodeling is mainly used in system and program engineering for more rigorous descriptions of structures, semantics and limitations of models or systems. It is used mainly for conceptual modeling, domain modeling, and modeling of structural relationships between concepts related to data, information and knowledge. When it comes to scope, conceptual mapping is usually used for displaying a certain area or knowledge area, enabling organization of ideas and understanding of relationships within it. Metamodeling has a wider use and provides a framework for defining structure and property of a model in general. Speaking about abstraction, conceptual mapping is often used for high concepts and relationships, allowing for a wider overview of the

area, whilst metamodeling goes in more detail, also defining structure and semantics of certain models or the modeling language.

So, in this thesis, metamodeling with UML is also conceptual mapping, but vice versa does not apply. The reason why conceptual mapping is not also metamodeling is that the focus of conceptual mapping is visualization of knowledge and concepts, whilst metamodeling focuses on defining structures and semantics of models and systems.

### 2.4.1. Conceptual Mapping<sup>2</sup>

**Conceptual mapping** will be conducted in such way that every previously mentioned VDML concept in the subchapter 2.3. is recognized in DIH documents selected for this research, in order to conduct conformance analysis. Concept maps are graphical representations of knowledge, formed as hierarchical representations of different concepts and their relationships, where the most general concept is on the very top, creating conditions for meaningful learning [45]. Each mapped concept is displayed in Table 23., Table 24., Table 25., Table 26., Table 27., Table 28., Table 29. and Table 30. The first column of the table consists of VDML classes mentioned in the subchapter 2.4. necessary for the conformance analysis. Each literature source is placed in one column, providing examples of these concepts. At the far-right side, there is a column for comments. OMG's specification's classes 'Activity', 'Value and Value Proposition', and 'Resources and Stores' [19] were added, because they could be utilized by other methods. The first row of the Tables 1-8 is occupied by DIH RMM, which is a ValueDeliveryModel class. The second row is reserved for DIH Model; VdmlElement class.

The following are some mapped concepts class examples:

- a) Collaboration class: medium-sized, micro- and small enterprises; large companies (DIH customers); mid-caps; cluster organizations from other regions; regional cluster organizations; chambers of commerce; regional government; trade associations;

---

<sup>2</sup> From the article written by Jurčić and Strahonja [40].

- vocational training organizations; innovation support organizations; funding organizations; investors; incubators: national government;
- b) Inherent examples of Role class: policy creator; knowledge provider; technology provider; technology recipient; knowledge recipient; infrastructure provider; funding recipient;
  - c) Community class: medium-sized enterprises; micro- and small enterprises; large companies; mid-caps; internal human capital: internal skills (employed/affiliated); business actors inside DIH ecosystem; public actors inside DIH consortium; universities belonging to DIH consortium; business actors within the DIH consortium;
  - d) Member class inherent examples: individual employees in DIH; individual employees within companies (focus on executives and decision makers); individuals in public entities in DIH consortium; individuals at universities belonging to DIH consortium;
  - e) Activity class: internationalization; educating; skill developing; training; helping with business plans; business advising; supporting scale-up; matching firms and customers; attracting funding; testing and validating; DIH activities financing;
  - f) BusinessNetwork class: cluster organizations from other regions; regional cluster organizations; chambers of commerce; regional government; trade associations; innovation support organizations; EEN local; incubators; funding organizations; national government; vocational training organizations; investors;
  - g) Collaboration class: micro- and small enterprises; mid-caps; medium-sized enterprises; large companies (DIH customers); cluster organizations from other regions; regional cluster organizations; chambers of commerce; regional government; EEN local; trade associations; innovation support organizations; vocational training organizations; incubators; national government; funding organizations;
  - h) Role class inherent examples: knowledge/technology provider; policy creator; knowledge/technology recipient; infrastructure provider; funding recipient;
  - i) Party class inherent examples: regional clusters; chambers of commerce; governments; EEN; trade associations; incubators; vocational training organizations; innovation

support organizations; funding organizations other DIHs; investors; universities not in DIH; public actors not in DIH; business actors not in DIH;

j) Value and Value Proposition class: TT [43].

Table 1. below is an example of the table used for conceptual mapping based on [19]., filled with information gathered from DIH literature.

Table 1. Conceptual Mapping Table.

<b>VDML concepts</b>	<b>Lit source</b>	<b>Lit source comments</b>
<b>ValueDeliveryModel (7.2.3.1.1)</b>		
<b>VdmlElement (7.2.4.1.1)</b>		
<b>MeasurableElement (7.2.4.1.4)</b>		
<b>Attributes (7.2.4.1.2)</b>		
<b>Annotation (7.2.4.1.3)</b>		
<b>MeasuredCharacteristic (7.2.4.1.5)</b>		
<b>PortContainer (7.2.4.3.4)</b>		
<b>Collaboration (7.2.1.1.3)</b>		
<b>Role (7.2.1.1.5)</b>		
<b>RoleDefinition (7.2.5.5.2)</b>		
<b>RoleLibrary (7.2.5.5.1)</b>		
<b>RoleCategory (7.2.5.5.3)</b>		
<b>Participant (7.2.1.1.4)</b>		
<b>Actor (7.2.1.1.1)</b>		
<b>Person (7.2.1.1.2)</b>		
<b>Assignment (7.2.1.2.3)</b>		
<b>OrgUnit (7.2.2.3.1)</b>		
<b>Position (7.2.2.3.2)</b>		
<b>Community (7.2.2.2.1)</b>		
<b>Member (7.2.2.2.2)</b>		
<b>BusinessNetwork (7.2.2.1.1)</b>		
<b>Party (7.2.2.1.2)</b>		
<b>7.1.2 Value and Value Proposition</b>		
<b>7.1.9 Activity</b>		
<b>7.1.11 Resources and Stores</b>		

In conclusion, it is to be said that conceptual mapping will be conducted in the third phase of DSR, so that every previously mentioned VDML concept related to DIH RMM creation methodology is recognized in DIH documents selected for this research.



### 2.4.2. The Instrument

In phase three, **instruments** for the qualitative semi-structured in-depth interviews for both phases were designed and can be seen in Appendix 7: Instruments for semi-structured in-depth interviews with DIH experts. One instrument was created for the first part of the interviewing process with DIH experts and another for the second part with DIHs. Interviews will be conducted in the fourth phase, with different experts and authorities needed for verification of a model and also gathering additional information not available in literature. Expert opinion method will be used.

Firstly, five interviews will be conducted with DIH experts from EC and national authorities. During the first part of the interviewing process, interviewees will be asked what they think about the questions planned for the second part. With that, instrument for the second part of the interviewing process will be tested, i.e., priorly verified by experts. In the second phase, interviews are to be conducted with different DIH experts.

These experts from EC and national authorities- scientists and practitioners with relevant DIH knowledge and experience- will be used for evaluation of the second interviewing instrument. They will evaluate different aspects of the instrument, provide feedback in form of suggestions for improvement, reported potential problems or limitations. The advantage of this kind of expert evaluation is correction of the instrument before being used on the wider pool of interviewees, which rises reliability and validity of the instrument. Experts used for creation and validation of the instrument can also be used as a part of the pool of interviewees, especially taking into account the fact that experts for the given area are scarce. In Appendix 9: Interview Stats, there is a list explaining who they are and where they are from. If the wider audience was to be included i.e., scientists working in related areas such as innovations, techno park leaders which are not DIHs, IT entrepreneurs etc. the level of expertise would significantly decrease. It is important to stress that expert evaluation is an additional step used before conducting of wider interviewing research. Also, no conflict of interest was recognized, which could lead experts in the pool of interviewees to be biased, and which could make their answers impact evaluation of the instrument. Therefore, experts checking the formal validity of the instrument can be a part of the pool which later on participates

in interviewing process. Expert analysis allows the use of expert knowledge in order to identify potential shortfalls before use on the wider pools of interviewees.

Instruments for the qualitative semi-structured in-depth interviews will be created, as a part of the third phase of DSR. There were no legal and ethical considerations to be taken into account. No vulnerable or under aged social groups were interviewed, and interviewing was conducted with signed consent. Also, questions asked were not of delicate nature and in no way related to ethical matters.

## 2.5. Fourth Phase Description: Evaluation

Fourth phase consists of two parts; one is verification, and the other is validation. Qualitative in-depth interview will be conducted, with instruments described in section 2.4.2., in order to collect information from DIH experts. Expert opinion method will be used. Based on the gathered results, VDML DIH metamodel will be verified; evaluated and adjusted.

Firstly, five interviews will be conducted with DIH experts from EC and national authorities. The main goal of this first part of interviewing was to obtain confirmation regarding the suitability of the selected DIH cases from DIH expert literature chosen for DIH RMM design, the suitability of referent architectures put in DIH context, to verify the initial DIH model and metamodel, and to identify missing, unnecessary or incorrect DIH RMM artifacts/elements, all in order to confirm, adjust or redefine DIH RMM. The interviewees should be able to recognize real world concepts and do mapping between M0 and M1 conceptual levels.

In the second phase, interviews will be conducted with different DIH experts. The main goal of this part of interviewing was to identify missing, unnecessary or incorrect DIH RMM artifacts/elements, to establish the degree of compliance and incompatibilities of DIH with VDML metamodel, as well as to confirm, adjust or redefine DIH RMM. Following the interviews, and also as a part of the verification, some practical examples were used- DIH Catalogue and examples of some other entities, for which DIH RMM could also be used.

This chapter describes the process of verification, and also validation of DIH RMM by a focus group following VDML DIH metamodel verification. Focus group will be composed of four DIH experts from Croatia or other EU Member States, in order to confirm the model.

## 2.6. Fifth Phase Description: Conclusions

In the fifth phase- Conclusions, proposal of RMM DIH will be designed, and degree of compliance and incompatibilities of DIH with VDML metamodel will be provided. Phase five of DSR in Chapter 7. will explain alignment with all research objectives and hypotheses previously described in subchapter 1.2. Conclusions will be made, based on theoretical and practical research conducted throughout previous four DSR phases.

Phase five concludes DSR framework used in this thesis. There will be one more chapter following this one, and it will be conclusions of the entire thesis.

## 2.7. Chapter conclusions

DSR was deemed the best approach for this thesis. Its five phases were described, as well as other scientific methods will be used: scientific and expert literature review, conceptual mapping, (meta)modeling; mapping onto other methodologies, in-depth interview, and a focus group.

The research will be conducted in five phases, following the phases of design science research framework. In the First Phase, qualitative research will be conducted through literature review, which will enable establishment of the wider research context.

The Second Phase, focuses on the hypothesis claiming that the business model of a DIH is in its essence a delivery of value. Methodology of an entire thesis is explained here; the proposed DIH-UML-MOF methodology and VDML profile extended metamodeling, all as a part of DIH RMM

creation methodology. It also explains how Conformance Analysis will be conducted at VDML Collaboration Modeling Conformance level.

In the third phase, artifacts will be created. Conceptual mapping will be conducted, so that every previously mentioned VDML concept related to DIH RMM creation methodology will be recognized in DIH documents selected for this research. Instruments for the qualitative semi-structured in-depth interviews will be designed.

In this thesis, metamodeling with UML is also conceptual mapping, but vice versa does not apply. The reason why conceptual mapping is not also metamodeling is that focus of conceptual mapping is visualization of knowledge and concepts, whilst metamodeling focuses on defining structures and semantics of models and systems.

Phase four discusses processes of verification, and also validation of DIH RMM by a focus group. Focus group will be composed of four DIH experts from Croatia or other EU Member States, in order to confirm the model.

Phase five concludes DSR framework used in this thesis. There will be one more chapter following this one, and it will be conclusions of the entire thesis. There were no legal and ethical considerations to be taken into account. No vulnerable or under aged social groups will be interviewed, and interviewing will be conducted with signed consents. Also, questions asked were not of delicate nature and in no way related to ethical matters.

### 3. FIRST PHASE EXECUTION: GENERAL THEORY

This chapter shows the result of literature review conducted for the thesis. Scientific foundation of this thesis is based on scientific theory in the area of KT and TT from research community to industry and vice versa. Articles chosen for the research are organized in various different subchapters.

The justification for this chapter is finding an answer to two objectives of this research: (1) Identification of factors which influence problems of intermediaries in KT from research community to industry and vice versa, and how does DIH fit into that; and (2) Identification of DIH similarities and specifics in comparison to other intermediaries.

Scientific literature review regarding KT from Research Community to Industry and vice versa will be elaborated upon in 3.1. subchapter. In the area of KT, the focus of the thesis narrows down to intermediaries in those processes. Amongst different intermediaries, the focus further narrows down to DIHs. It is only logical that the section 3.1.6. discussing DIHs comes next, elaborating upon literature found on DIH topic, which is mostly not of scientific nature, for scientific articles on DIH topic are scarce. Problems of Intermediaries are listed in section 3.1.8., which installs structure in scientific literature regarding problems which different kinds of intermediary organizations encounter in their work. TT introduction subchapter 3.2. reflects upon scientific literature review chosen for the research regarding TT. The final subchapter is Chapter Conclusions 3.3.

As already mentioned, the scientific foundation of this thesis is in KT and TT from research community to industry and vice versa. The “vice versa” refers to the circular nature of KT and TT. The fact that often today, especially in IT, the industry knows more than research community, and so KT and TT go in reverse from their traditional direction.

### 3.1. Knowledge Transfer from Research Community to Industry and Vice Versa

KT processes can go in many different directions and between different stakeholders. The focus of this thesis is KT from research community to industry because vast majority of scientific articles elaborate upon the direction from some kind of academic and/or research entity, and vice versa. The direction of KT towards industry is more traditional approach, but today, many things have changed and often industry knows more through practical experience, especially in technical fields and disciplines. ICT is one of them, so it is important to reflect upon both KT directions. For instance, in applied research area of software engineering, the preference is that KT is conducted bi-directionally by industry and academia jointly [46, p. 1]. Also, academic engagement, is trying to develop new knowledge which is of benefit to both the academic community and industry, the prerequisite for which is bidirectional knowledge sharing, in order to, amongst other things, transfer knowledge or technology [47, p. 1237].

It wasn't until the beginning of this millennium that scientific articles discussing problems of intermediaries in KT processes started appearing. In this subchapter, the clustering of articles by themes came naturally through the process of literature review, as certain thematic clusters became apparent as the most usual topics; Networking, Social capital, The Helices, Patents and Intellectual Property Matters, Intermediaries and Other General Matters.

#### 3.1.1. Networking

Through literature review, networking is one of the usual topics when it comes to KT from Research Community to Industry and vice versa. Within the topic of networking, it is noticeable that some elements are reoccurring and stand out as most important. Those are the following: network cohesion, range, size, proximity, boundary spanners, clusters and broader set of knowledge resources.

When it comes to **network cohesion** between partners, it has a different impact depending on the type of knowledge being transferred. In this thesis, network cohesion pertains to the closeness of

relationships in network interactions. Network cohesion has a negative impact on technological KT and positive on foreign marketing knowledge [48, p. 440] because closer connections induce reliability of marketing knowledge, and few connections ensure not widespread and novel technological knowledge development capabilities necessary for competitiveness [48, p. 425]. With that, it's important to have on mind that technological knowledge is defined as "knowledge regarding scientific and technical advances on an applied, high-technology product" [49, p. 219]. On the other hand, foreign marketing knowledge is defined as "knowledge from one country unit that may offer value and competitive advantage to marketing managers in other country unit" [50, p. 1]. Companies within cohesive network are willing to find new partners in complementary, preferably out of their constrained and activity-based network [51].

When network structure is in question, besides cohesion, **range** is also an important element for enhancing KT, favoring the process through connections within or beyond organizational boundaries [52, pp. 242-261]. In this thesis, range will be considered the extent of a network; what all a network encompasses.

In networking, **size** also matters. Large companies prefer working with bigger companies, universities don't take size into account when choosing partner universities, bigger universities prefer working with bigger companies, whilst for companies, size does not play a role when choosing a university institution to work with [53, p. 183]. It also matters when speaking about **proximity**; bigger companies and universities more intensely involved in research cover larger geographical scopes with links [54, p. 247].

Graduate students working on a project also play a role in networking. KT Partnership concept from UK, allows not so research-intensive universities to develop greater role in UIC, by linking companies with a graduate employed as associate at university and working on a project in a company between 6 and 36 months, transferring knowledge and skills [55, pp. 4-5]. More and more SMEs participate in these partnerships and projects, which are funded by both government grant aid and industry [56, p. 10]. These graduate students fall under the category of so-called **boundary**

**spanners**; outplaced personnel between different sectors [57, p. 1237]. Adoption of dual identity is important for that person, and so is having the capability to understand perspectives of all involved parties [58, p. 18]. Every organization has its boundaries, which are defining its characteristics, whilst boundary roles present a linkage between organization the environment [59, p. 217]. UIC go along one of eight modes of partnership: sponsoring, collaborative research, creation of new curriculums aligned with industry needs, academic entrepreneurship, transfer of personnel, property rights commercialization, and scientific publication direction [60, pp. 65-67].

**Clusters** are also often mentioned in scientific literature pertaining to KT. Scientific-research clusters are non-profit organizations which are to make KT from research institutions to companies, primarily SMEs, more efficient, whilst maintaining the strategic relationships with scientific bodies, private and government bodies [61, pp. 294-296]. The same source also states that importance is given to benefits which research institutions receive from industry, such as sponsorship and the use of industrial facilities and equipment [61, p. 296]. So, it is evident that the idea is for the benefits to flow both ways. Some authors claim that universities have a very important role when connecting companies and creating communication and networking amongst them, and that without them only little disparate company clusters would exist [53, p. 183].

In Latin America, research departments at universities, institutes and agencies have a **broader set of knowledge sources** within a scientific discipline when working closely with industry, because they acquire relevant information early and firms therefore see them as more reputable and capable [62, p. 897].

Networking is an important part of KT, and elements associated with it in scientific literature are: network cohesion, range, size, proximity, boundary spanners, clusters and broader set of knowledge resources. Here, a brief explanation and some basic definitions of those elements.



### 3.1.2. Social capital

Social capital is usually considered asset of the utmost importance in any organization. As such, it for sure has a well-deserved place in scientific literature in the area of KT from Research Community to Industry and vice versa. Some of the elements which stand out as important are scientist seniority, cultural differences, autonomy, cross-boundary relationships, academic entrepreneurs, entrepreneurial academics, and finally cognitive and relational social capital.

Many articles discuss the reasons why some scientists choose to cooperate with industry, what are their characteristics and what their motivations are. Some argue that local environment in form of peer effects, mostly peer benchmarking, has an immense impact [63, p. 1190]. The same source also states that this is a more common practice amongst junior scientists and lower performers, with relevant and similar others, and the reason may also be competition [63, p. 1200]. For the **senior** scientists, such as tenured staff, organizational autonomy in terms of impact on collaboration issues, plays a bigger role [64, pp. 147-148]. The same source argues that more senior scientists are therefore more likely to engage in KT between university and industry, emphasizing the link between seniority and desire for autonomy [64, p. 153], and that scientists should have a leading role in the University- Industry Collaboration (UIC) projects [64, p. 154].

Some researchers studied the influence of cultural differences and the choice of partners on KT. When it comes to institutional **cultural differences** between different university centers and researchers, it appears to enhance the cooperation [65, p. 68], and partner selection [65, p. 66]. Some research conducted in the past had shown different results, but as the world is increasingly becoming a “global village”, practices change.

When it comes to scientists’ behavior, the need for scientists’ **autonomy** within different organizational forms in regards to decision making about collaboration issues and strategic interdependence in terms for resources, is also a very important factor which influences the scientists’ decision regarding getting involved in KT processes between university and industry

[64, p. 139]. The same source also states that there are four scientists' behavior types or managerial models of behavior, which distribute scientists across the spectrum, having in mind different ratios in which they give importance to their personal goals and the need for external resources [64, pp. 142-143]. Therefore, it can be concluded that these four scientists' profiles' degree of idealism vs realistic needs for means is different. The higher need for either of the two motives, the higher chance of KT occurrence [64, p. 151]. It is also interesting to point out that, when it comes to UIC, scientists are more likely to compromise operational than scientific autonomy pertaining to research direction and execution; they can remain focused or become flexible [66, pp. 393-396]. The same source further explains that the explanation for fair flexibility and opportunity-drive is the initial lack of project clarity [66, p. 404].

Frequent communication between actors at both university and industry side of collaboration and different activities involving close personal interaction facilitate identification, trust and shared meaning, and therefore ease the tension in **cross- boundary relationships** [3, p. 13]. They also foster shared values and norms [67, p. 2]. Also, an important other factor is the scientists' will to also contribute to society, which also favors cross- boundary activities between academia and other actors [67, p. 10]. In this thesis, cross- boundary relationships pertain to collaborations between members of academic community and industry.

Terms like **academic entrepreneurs** and **entrepreneurial academics** should also be mentioned. The first of these two favor licenses, joint ventures, spin-outs and patents, whilst the other favor joint activities (journal publications, supervision of research student and their placement, industry conferences), secondments, networking, executive education, contracted research and consultancy, and collaborative research [68, p. 25]. Some claim that academic excellence has little to do with researcher's entrepreneurial quests, whilst scientific breadth does [69]. The same source states that academics who took part in invention processes were more likely to pursue entrepreneurial activities [69]. One research conducted in China shows that academic rank, connections with industry, gender and previous experience have an impact on self-efficacy and therefore academic engagement, making male senior scientists with prior experience and external position more prone to collaboration [70, p. 171]. These results would probably be different in north-western European

countries, especially pertaining to gender. So, when contemplating upon research results, it is therefore also important to put things into perspective. As a solution to these entrepreneurship challenges related to academics, some propose establishment of entrepreneurship education ecosystem in order to help install entrepreneurship culture in academia, through the access of already existing entrepreneurial modules or through creation of subject-specific ones and their inclusion in the study programs [71]. Academic entrepreneurs should possess certain competence for achieving success. The two very important ones are opportunity refinement, an ability to seize an opportunity, championing, and ability to persuade other stakeholders into contribution [72].

**Cognitive and relational social capital** also come into play when it comes to UIC, depending on the level of firm experience; more experienced ones initially rely on cognitive capital and relational over time, whilst it is the other way around with others [73, p. 1164]. Cognitive social capital encompasses feelings of sharing, support, trust and reciprocity [74, p. 106], assuming shared codes, language and narratives [75, p. 251], whilst relational assumes close personal interaction of cooperating partners [76, p. 221], encompassing trust and commitment [77, p. 5].

Social capital discussion takes an important part of scientific literature. The review of the most important elements encompassed: scientist seniority, cultural differences, autonomy, cross-boundary relationships, academic entrepreneurs, entrepreneurial academics, and finally cognitive and relational social capital.

### 3.1.3. The Helices

In KT processes Helices are often mentioned. In the literature review performed for the thesis, Triple Helix (TH) and Quadruple Helix (QH) occurred. When speaking about managing an organization, most often the term TH is being mentioned. QH includes also a fourth element besides the three contained in TH, as will be explained in text below.

**TH** is a concept explaining the interaction of the industry, government and academic community; the three helices [78, p. 370]. Etzkowitz and Leydesdorff describe the evolution TH; in the first

model, which can be found in socialist states, the state manages academics community, industry, and the relations between them; the second model is composed of three different institutional entities with clear boundaries; whilst the in third three institutional entities overlap, which is a good practice of the western countries [79, p. 111]. The same authors further explain that it is not imperative for TH to be stable and that the biological metaphor cannot be taken literally; the biological evolutionary theory builds upon the hypothesis that variation and selection are naturally given, whilst cultural theory claims hypothesizes that individuals and groups make conscious decisions and cause unintentional consequences, and that every helix can connect the other two and create communication, network and organization or institutional order [79, p. 112]. They also mention that the TH hypothesis is that systems can stay in transition permanently, constantly modeling each other through that mutual evolution [79, pp. 113-115]. TH allows for the patent creation as a result of interaction of the three helices [40, p. 370], and patents will be elaborated upon in section 3.1.4.

**QH** involves culture-media public as a fourth element of the helix [80, p. 201]. That helix element is connected to media, creative industry, culture, values, lifestyle and art; culture and values create public opinion which is communicated and formed through media, impacting national innovation attitude [80, p. 206]. Therefore, QH includes TH and also societal based innovation users [81, p. 7]. Type of university also plays a role in QH at micro level, because it has an impact on stakeholder salience and also involvement, which inevitably reflects upon all the other processes regarding technology commercialization [82, p. 1058]. The concept of QH is a part of **Smart Specialisation** concept; political framework based on innovation, which allows innovations strictly connected to science and technology [83, p. 382].

Successful system of KT can be created through cooperation of public sector and academic community, whilst cooperation of private sector and academic community will allow entrepreneurship based on knowledge [84, p. 972]. The three most successful states in TH implementation are Italy, Netherlands and Bask region in Spain [85]. China established joint R&D institutes; cooperative research centers established by Chinese universities which offer culture, knowledge and human capital, but also international companies which provide equipment, funding and information about needed talents [86, pp. 7133-7134].

TH and QH are concepts often found in scientific literature focused on KT. The interconnection of different stakeholders in processes of KT has an immense impact on the synergy created, which should not be overlooked.

#### 3.1.4. Patents and Intellectual Property Matters

Patenting is also an important aspect in the KT, so a significant part of scientific literature discusses it. In scientific literature on the topic of patenting, some of the terms often mentioned are absorptive capacity, commercialization and ownership.

Out of an entire number of Information and Communication Technologies (ICT) patent applications in 2012, only 31.5% were European Patent Office (EPO) patent applications, and out of that percentage, only 32% were submitted by EU Member States (MS) [87]. The same source mentions that from 2004 until 2014, the number of failed EPO patent applications decreased for a number of EU MS, amongst which also for Republic of Croatia. This data is indicative because licensing patents is one of the methods of TT [88]. Patent management is more difficult for individuals and SMEs because patent registration requires legal knowledge and also funds [89, p. 101132]. SMEs are also biggest academic patents absorbers [90, p. 538].

It is interesting to mention that the patent number is the measure for new knowledge, whilst expenditure or employment is the measure of university research [12, p. 184]. Academic engagement differs from **commercialization**, which involves patents, because it is more connected to traditional research activities and resources in support of it [12, p. 423].

When it comes to competitiveness on the global market, patents and acquisition of external knowledge play a great role, emphasizing the importance of **absorptive capacity** [91, p. 96]. Absorptive capacity is defined as “The ability of a firm to recognize the value of new, external information, assimilate it, and apply it to commercial ends” [92, p. 128]. The same source further states that the prerequisite for it is the possession of prior related knowledge [92, p. 129]. Absorptive capacity resides on common knowledge, as new knowledge is more easily absorbed in

areas where some common knowledge already exists within giver and taker of the knowledge being transferred [52, p. 234].

Patent **ownerships** is also an important issue to look into. Here, policy and funding play a big role; university ownership is proportional to SME funding, funding from big companies is proportional to industry ownership funding, and public funding to university ownership without spin-off ownership [93, pp. 385-298]. The issue of ownership is important because it of course presents a form of income for the owner. Often, university creates spin-offs, new companies commercializing the invention, holding equity in it [93]. The “third mission” of universities is active engagement in KT and therefore “ivory tower” university metaphor is no longer acceptable; KT can be conducted either through “open science” channels (publications and conferences), direct collaborative relationships (contracted research, consultancy, joint ventures, research facilities and equipment sharing), employment (secondments, graduate students, personnel exchange), or through university patents licensing or sale [94]. At Stanford University, regardless of the fact that a patent belongs to university, faculty and staff who invented it can decide that no license is required for its use, and also material transfer agreements are very simplified in procedure, all in order to ease the UIC [95]. Industry owned patents tend to be more simple inventions compared to those belonging to public science sector [96, p. 755].

Issues of patenting are elaborated here in more detail, because it is also an important element of KT processes. Absorptive capacity, commercialization and ownership are reoccurring themes, which were given some explanation here.

### 3.1.5. Intermediaries

In the scientific theory of KT from research community to industry and vice versa, the focus of the thesis further narrows down to intermediaries in those processes. Here, intermediaries and their roles, thus elaborates further upon different kinds of them.

Overall, intermediaries are organizational structures, which serve as catalysts in KT and require better insight. They do the matching of industry needs through KT, provide linkage to financing sources [2, p. 120], contribute to developing trust and enhance partner identification [3, p. 13]. There is also an issue of social responsibility, putting a focus on intermediaries' brokerage role, whilst matching potential parties for collaboration [4, p. 3]. Those responsibilities would include opportunities for all parties involved in terms of economic, ecological and socio-political sustainability [4, p. 14]. Intermediaries' business model, channel choice and internal structure allow for an optimal response [5, p. 4]. Companies which choose to interact with academia tend to be larger and have higher absorptive capacity [97, p. 57]. Some researchers suggest that intermediaries should remain flexible in their commercialization approach [98, p. 72]. Intermediaries can especially be important in developing countries, because they can reduce time, cost and business risks [99, p. 128].

There are numerous intermediaries, which can be found in scientific literature, all with similar missions which include bringing different stakeholders together in some number of helices. Some of those intermediaries are: University Knowledge Transfer Offices (UKTOs) [4] sometimes called University Innovation Offices (UIOs) [4], Technology Transfer Offices (TTOs) [4] [100] [101]; Knowledge Transfer Offices (KTOs) [5] [97]; Research and Technology Organizations (RTOs) [102]; University Technology Transfer Offices (UTTOs) [103]; University Incubators (UIs) [104]; Collaborative Research Centres (CRCs) [104]; science parks [105], and DIHs [6].

RTOs have a key role in technology-innovation ecosystem; as intermediaries between academia/research community and industry, through applied research and technology development in function of innovation, they also have to implement **Smart Specialization Strategies (S3)** [106, pp. 3-4].

There are many different kinds of intermediaries in KT processes. There are also many different problems regarding intermediaries about which scientific literature elaborates in much length. They

are listed and grouped in clusters, in one of the following parts of the thesis below. The focus of this thesis further narrows down to DIHs, as special kinds of intermediaries.

### 3.1.6. Digital Innovation Hubs

DIHs, as special kinds of intermediaries in KT processes, are the main focus of this thesis. This part of thesis is based on the article written by Jurčić and Strahonja [40], which discusses DIHs, and will serve as a framework for further DIH elaboration throughout entire thesis. European Digital Innovation Hubs (EDIHs) will also be described here.

DIHs are the focal point of Digitalizing European Industry Strategy, which was published by EC in 2016 [6]. In that regard, they are one of the newest intermediary organizational structures. The concept of DIHs was introduced because the degree of digitalization throughout EU should become homogenous, because such novel structure is necessary for improving EU's international market competitiveness, and because of the concerning fact that only a small number, one fifth, of all EU SMEs is considered to be highly digitalized [10]. Digital Economy and Society Index (DESI) is a European digital performance measure, which also tracks EU MS' digital competitiveness progress [107]. When it comes to enterprises' digital technologies adoption, data from 2019 shows that big companies more often adopt new technologies; 78% of big companies and 33% of SMEs use Enterprise Resource Planning (ERP) software for electronic information sharing, 62% of big companies and 32% of SMEs use Customer Relationship Management (CRM) for client information marketing analysis, 78% of big companies and 52% of SMEs are social media active, 39% of big companies and 18% of SMEs sell online, and finally 23% of big companies and 8% of SMEs sell internationally online [108, p. 7]. The concern is even greater when that ratio is put in perspective of another fact, and that is that SMEs take credit for 99% of entire EU business [9]. Looking at DESI for 2020, Croatia's is on 20<sup>th</sup> place in EU (out of total 28 EU MS) [109, p. 3]. When it comes to integration of digital technology, Croatia is on 12<sup>th</sup> place; 21% of SMEs sell online, 10% sell internationally within EU, 22% use cloud solutions, 22% of all companies use social media actively, and 26% of all companies share information electronically [109, p. 10]. DIH Mission is depicted on Fig. 4. below.



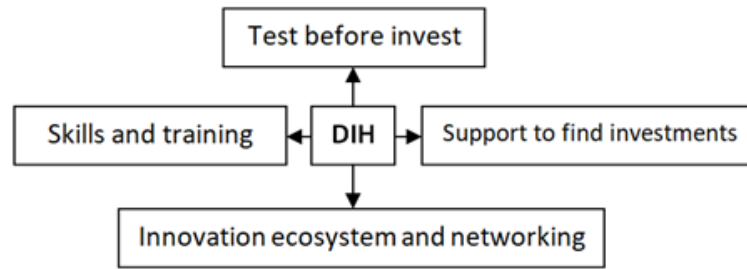

Fig. 4. DIH Mission. Source: Adjusted from EC publication [23], from the article written by Jurčić and Strahonja [40].

DIH is therefore a policy instrument for making the necessary DT support freely available [110]. They help different companies of all sizes with digitalizing their businesses through numerous one-stop-shop services, relying on KT and TT from technical universities or research establishments, which are positioned at their core [10]. The list DIHs basic offers can be found in DIHELP guide for Applicants, and they are the following: "access to digital technologies and competences, infrastructure and training to test digital innovations, financing advice, market intelligence, networking opportunities, access to digital skills development and training" [111, pp. 2-3]. Formulation of DIH's value proposition should take into account industry's needs, and then that value proposition should be designed as a unique offer [112]. The support of existing industrial potential and DT needs is the starting point for that [63]. EU MS have different Smart Specialization Strategies (S3), with a list of research and investment priority areas in accordance with European Cohesion Policy 2014-2020 [25]. DIHs should, unlike clusters be the first regional points of contact, for the industries' DT demands [10]. In that context, proximity is also important; geographically isolated poorly populated locations have troubles attracting workforce which is well skilled and talented, and that can be solved with additional investments [24].

DIHs try to create synergy by gathering different stakeholders, different EU MS, regional policies, industry (with focus on SMEs), research entities and academia. DIH also conducts matchmaking/brokering, through events, websites, showrooms, supplier networking, various different organizations' complementarities promotion [110], and also through hackathons, innovation camps, roadshows and workshops [26, p. 12]. DIHs today are one of the following: already existing rebranded actors, already existing actors with new DT focus, or new actors created

for that specific purpose [113]. Criteria for DIHs and what all they should consist of, was not yet prescribed by EC [114].

EU MS should invest in their DIHs also by using European Regional Development Funds (ERDF), in alignment with their digitalization strategies [115]. The same source mentions that EC has been awarding 100 mil €/year since 2016, in order to enable pan-European DIH network; a compensation for the lack of resources, creating conditions for KT [115]. DIHs financing is usually maintained through membership fees, public funds, and commercializing their selected specialized services [116]; most DIHs are not directly financed by their respective S3s [117].

Scientific DIH sources are small in number. The biggest number of sources regarding DIHs used for this dissertation are platforms and technical reports from EC's Joint Research Centre (JRC). Digital Innovation Hubs tool, created as a DIH networking platform, provides a list of DIHs and their basic information [118]. It lists DIHs in Europe; in EU member and non-member states, their evolutionary stages (potential DIHs from Horizon 2020 Programme, in preparation, or fully operational), 25 covered competences technical in nature, 15 different provided services, 20 market sectors, 8 Technology Readiness Levels (TRL), and Horizon 2020 Programme projects involvement [111]. The tool shows a list and also uses an interactive map for DIH information display, momentarily counting 724 DIHs [118]. JRC's DIH catalogue interactive community called DIHNET.EU project, encourages collaboration of European DIH network, in an effort to create added value based on cooperable, coordinated, and sustainable pan-European network of networks, through organizing DIH Champions Challenge, tools, services to regional DIHs [119].

Digital Europe Programme (DEP) is proposed for the next six-year period to improve DT, has a focus on providing funds for supercomputing, enhancement of EU strategic digital capacities, cyber security, advanced digital skills, artificial intelligence, and installing digital technologies throughout EU [120]. It is therefore evident that EC will keep investing in DIHs; DEP will ensure grants for a DIH per region in EU, and those DIHs will be named EDIHs [114].

This part of the thesis is one of crucial ones, as it explains the essence of DIHs, which are intermediaries in the KT processes from research community to industry and vice versa. These one-stop-shops focusing on DT of mostly SMEs and mid-caps, are the main focus of this thesis.

### 3.1.7. European Digital Innovation Hubs

In 2016, DIHs were first mentioned, and in 2022 the first EDIHs started appearing. In this thesis, EDIHs will be considered a special kind of DIHs, which in essence they are. Introductory information regarding EDIHs will be given here, and more gathered information regarding them will be given later in the thesis.

EDIH is defined as:

a single entity or a coordinated group of entities with complementary expertise and a not-for-profit objective to support on a large scale the digital transformation of (1) companies, especially SMEs and small mid-caps, and/or (2) public sector organizations conducting non-economic activities [121, p. 6].

It is evident from the given definition that EDIH is defined in a very similar way as a DIH. European EDIH network aims to cover all European regions and provide services such as: development, training and skills, testing before investing, finding investments, access to innovation ecosystems and networking [121, p. 6]. It is apparent that EDIH and DIH services descriptions also overlap. Besides all mentioned, EDIHs should be multipliers and diffusers of the use of digital capacities in support of DEP's objectives in the areas of Cybersecurity, Artificial Intelligence (AI), Advanced Digital Skills, High Performance Computing (HPC) and should be accelerators of technologies' best use [121, p. 7].

EDIH consists of an RTO or university lab collaborating with different partners- Republic of Croatia was awarded 5 299 000 EUR for three years, by Directorate-General (DG) Connect (1 766 000 EUR budget per year), whilst recommended number of hubs was 2- 4 [121, pp. 9-10]. Therefore, DG Connect is providing 50% of the funding, and the other 50% of the required funding should be provided by MS and/or their regions [122]. National governments and regional authorities selected suitable entities to become EDIHs, and high-quality candidates which did not get into quota received a Seal of Excellence. [122].

On 21 Dec 2021, the call for tender aimed at creation of Digital Transformation Accelerator (DTA) was announced, with the purpose of providing support to EDIHs and accelerating DT of European economy, and the following main objectives: online presence, external communication, tools, training, community building, connecting to relevant activities, impact assessment, road mapping and support [123].

**DIH performance evaluation**, in terms of indicators and metrics, was also given a lot of thought when “evolving” towards the concept of EDIHs. They will have DTA, which is the central support office of the EDIH network. DTA will support the EDIH network through organization of events with a matchmaking purpose. Performance of EDIHs will be founded on several elements written in Digital Europe European Digital Innovation Hubs Work Programme 2021-2023, where targets and indicators to be evaluated are explained; amount of funding provided, number of EDIH customers, and number of established collaborations between EDIH and out-of-the-region stakeholders [124, p. 11]. The same document explains which additional impact indicators will be collected by DTA; EDIH customers’ digital maturity increase, for which JRC developed methodology and also innovations’ market creation and maturity [124, p. 11]. DTA will implement JRC’s methodology in order to make an online tool for helping EDIH customers fill in this data. This will be main feedback for evaluation of how EDIH network is performing. This feedback is very important for guidance in the shift of focus during the next EDIH call, which will take place in three years.

It is evident from the information provided here that EDIHs’ and DIH’s definitions, as well as the definitions of service they provide, overlap significantly. EDIHs will be considered a special kind of DIHs in this thesis, which in essence they are.

### 3.1.8. Problems of Intermediaries

The focus of this part of thesis will be the problems of intermediaries in KT processes from research community to industry and vice versa. Here, a part of the answer will be given to the first main

objective of this research: (1) Identification of factors which influence intermediaries in VD from research community to industry and vice versa. Answers to posed questions lie in literature review.

**The following are the problems of intermediaries recognized in literature and clustered:**

(1) Personnel Factors (underpaid [125] [126] [127]; under-capacitated [127]; lack of marketing experts [125] [126] [127]; lack of legal experts [127]; lack of licensing experts with negotiating skills [126]; too short involvement [128] [127]; lack of personnel with business [126] [127] and knowledge transfer experience [127]),

(2) Business Organization (bottlenecks [129]; bureaucracy [125] [126] [104]; stimulating measures [127]; complexity [130] [104] [126] [131]; inefficiency [127]; inflexibility [125] [126]; service value immeasurability and invisibility [128]; too long time from patent application to release of permit [132] [126]),

(3) Stakeholder Management (entrepreneur trust [133] [134] [102]; tensions between academic and commercial requests [128] [125]; alliance formation [133], attracting SMEs [133]; dual agent role-balancing professors and universities [127]; differences in organizational cultures between research community and SMEs [135] [125] [126] [127]; proximity [105] [104]; stimulating members of research community to reveal their discoveries [125] [127]; asymmetric information problem [127]; balancing expectations of academic freedom [132], knowledge sharing diffusion and use [102], as well as promotion of economic development of the region vs. industrial interests such as profit maximization, growth and competitive advantage [132], balancing expected demand and supply [128]; matchmaking [133] [127]).

This part of the research showed that there are about 50 recognized problems of intermediaries in the processes of KT from research community to industry, which can be clustered in three groups. So, a part of the answer to the first main objective of the thesis.

### 3.1.9. Other general matters

Trough KT literature review conducted for this thesis; most reoccurring themes were easily clustered. Some of themes which did not fit into any clusters which logically appeared so far were placed here. The most important elements which seem to appear are: KT channels, academic consulting, KT activities, knowledge enablers, occupational boundaries, boundary spanners, engaging external engineers, barriers, innovations, collaboration choices, human mobility, highly skilled professions and funding.

One research talks about **KT channels**, and shows that there are 29 recognized in the literature, and that they can be grouped into 7 clusters according to their objectives: publication, networking, mobility of researchers, joint research, intellectual property, cooperation and institutional infrastructure [136, p. 420]. Those clusters are further subdivided in different variables, whose KT level has then been assessed, and the results highlight scientific publication, networking of members of academia and industry, the importance policies and programs which would improve the research mobility, work collaboration, academia is in KT using IP less, cooperation with personnel inside and outside of the organization, and sharing facilities [136, pp. 425-426].

When speaking about KT, it is also important to mention **academic consulting**. Some studies show that consulting activities of academic scientists are mostly negatively correlated with number of publications, depending on the scientific field in question, whilst the effect of them depends also on engagement intensity; it is negative for high involvement [137, p. 73]. The explanation lies in the fact that researcher's time, as everyone else's, is a limited resource, and in spite of that, academic consulting is still more prominent KT channel then spin-offs and patenting [137, pp. 74-75].

Type of preferred **KT activities** also differs based on the scientific field in question. When it comes to Social Sciences and Humanities, they are contract research and consultancy, which should not be disregarded when considering criteria for KT measurement [138, pp. 16-17]. It was however

found that the research intensify is not a guarantee of efficiency; focus should rather be put on KT strategies taking into account resources [136, p. 29].

Another study mentions concepts such as **knowledge enablers**. Authors found that knowledge enablers (organizational culture, knowledge strategy, knowledge leadership and information technology) have a significant and positive relationship with KT [139, p. 194]. Since KT is considered a „nerve of knowledge management process within an organization” [139, p. 197], the importance of consideration for knowledge enablers is paramount. The same source further states that information technology is the most important out of all before mentions knowledge enablers, when KT is in question [139, p. 209].

**Occupational boundaries** are another concept being mentioned in KT discussions. It concerns combined activities of scientists and managers, which have to find modus operandi for different cultures, both organizational and occupational, for which a knowledge management technique so called Knowledge-stewarding Communities of Practice can be created in order to help with mitigation [140, p. 423]. Those communities organize, upgrade and distribute knowledge in the area they are very motivated for, and they can be a part of TH [140, pp. 432-435].

**Boundary spanners** are another concept worth mentioning, in the context of KT. They are important for SME's new business opportunities, trough bridges within SMEs and also towards academia [141, p. 400]. Brokers can be boundaries spanners but the other way around is not always the case [4, p. 8]. In this thesis, members of academic community are considered boundary spanners.

One research shows that **engaging external engineers** is enhancing KT, had he previously been a focal member, had good connections with one, or if he is a younger mobile person, which is an important information for choosing a KT interface spanning across national borders [142, pp. 76-77].

KT of course also has the following **barriers**: time deficit or preferred duration, different biases within universities and perceptions of academics regarding SMEs [143, p. 667]. Barriers can also be caused by decision-making process, and for that a set of meta-rules can be applied to different levels of abstraction [144, pp. 380-389].

KT is paramount for **innovations** and entrepreneurial companies [145, p. 46]. When speaking about innovation, it should be emphasized that KT can be a key component [146, p. 534]. Prior knowledge is necessary for innovation, to enable the company to perceive new external information's value, to possess a capability for assimilating and applying it; which means it should have the absorptive capacity for it [147, p. 128].

**Collaboration choices** of academics are more often focused on academia and industry than on government stakeholders [144]. Also, such collaboration across multiple geographical areas is uneconomical and should be focused on areas which offer the most in terms of novel knowledge acquisition and creation, yet links with external partners are favorable when such knowledge does not exist locally [144]. Local knowledge spillover model for example, takes into consideration that KT over larger geographical areas is more financially demanding and brings along information loss risk [148, p. 267]. It should also be stressed that quality is no more an issue after adequate partner is found [148], and speaking about adequate partners, trust a factor of the highest importance, which contributes to knowledge sharing [149, p. 24]. **Human mobility** should also be emphasized when discussing KT [150, p. 1114].

There are some articles discussing different solutions on how to create or find the best prepared and educated work force for the **highly skilled professions**. One of those is for example precision engineering applied for creation of optical applications [151]. When industry collaborates with academia, in most case s it is in order to develop interdisciplinary capabilities for complex tasks [72, p. 284]. Industry 4.0, a concept describing new age factories in which everyone and everything is connected and works seamlessly, requires tailored training for the workers in order to gain



necessary knowledge and skills for the complex work environment [152]. Another example of highly specialized KT solution is project „MATES“, from ERASMUS+, which puts in focus ocean literacy in both educational and industrial environments, in order to create adequately skilled working force, through the „COLUMBUS Knowledge Transfer Methodology“ [153, p. 1]. What makes this method's KT approach different is that it takes into account individual needs of all parties involved and plans communication accordingly [153, p. 3]. Open Innovation Sessions are KT platforms for high-tech companies, and it presumes external partner cooperation and information exchange between different stakeholders, reducing open innovation barriers [154, p. 69]. Some high-tech companies, operating in the domain of digital engineering, are optimizing KT through the use of virtual and augmented reality technologies, such as Review3D, Virtual Repository, Visual Assistance, 3D Decision Room for Participative Overhead Transmission Route Planning, Harz.EE-mobility and Smart Logistics Zones [155, pp. 4-13]. When speaking about innovation in construction industry, informal interaction, MSc students' thesis work in companies and PhD students from the industry are rated as a valuable form of collaboration, as well as work force mobility and joint research [156, p. 76]. In the field of Systems Engineering, the good practice is to put MSc students for three years in the industry-as-laboratory setting [157, p. 67]. In general, the recommendation for collaboration is for researchers to spend some time in an organization/company, to make sure their research and solutions are tailor-made [158, p. 33]. When speaking about specific industries and their peculiar KT issues, hotel management industry should also be mentioned. In hotel industry, investing in front-line work force creates competitive advantage [146, p. 331] and that special attention here should be placed on tacit knowledge [146, p. 330], more than on explicit. It is called „knowledge that leads to action“, and also the most difficult one to transfer [159, p. 534].

Not surprisingly, government **funding** also contributes to KT from academia to industry [160, p. 63]. It is however interesting that public funding and family management are negatively correlated to foreign direct investment spillovers' absorptive capacity, which points to the fact that companies with its own funding can absorb those spillovers better [161, p. 438].

Most reoccurring themes were easily clustered through KT literature review and themes which did not fit into any clusters were mentioned here in section 3.1.9. The most important elements which seem to appear, and which were not mentioned so far are: KT channels, academic consulting, KT activities, knowledge enablers, occupational boundaries, boundary spanners, engaging external engineers, barriers, innovations, collaboration choices, human mobility, highly skilled professions and funding.

### 3.2. Technology Transfer from Research Community to Industry and Vice Versa

Again here, the clustering of articles by themes came naturally through the process of literature review, as certain thematic clusters became apparent as the most usual topics. The subchapter is composed of the following thematic clusters: Commercialization, Funding, Innovation, Intermediaries, Models, Patents, Policy, Social factors, Spin-offs and Start-ups, and UI Collaboration, and Other Technology Transfer matters.

As an introduction to TT topics, some basic aspects of TT will be mentioned here. Technology Transfer is considered a commercial process, which involves different activities including the following: first communication with the prospective licensee, preparation of technical note and provisional patent application, preparation of material samples or prototypes, preparation of know-how documents etc. [162, p. 123]. Technology in TT should always be specified in agreement; what constitutes it, which elements it is composed of, and TT expectations [163, pp. 2-3]. One other definition of TT states that it is the process in which transfer agent develops technology with its knowledge associated to it, adapted and afterwards also applied, fulfilling technology recipient requirements and supporting innovation [164, p. 603]. Some define key aspects of TT as the following: policies pertaining to patenting, internal strategy, academic entrepreneurship, market and investment [165, p. 75]. Some authors define technology as a combination of frameworks, abilities, facilities and facts [166, p. 141].

In this research, TT will be considered a subset of KT. The concept of knowledge is focused on “knowing” and “what is”, whilst technology is focused on “doing”, “what it could be”, effectively

using knowledge [163, p. 2]. Most of TT includes know-how only and not know-why [166, p. 147]. Therefore, TT contains a limited scope of knowledge, which is the part limited to associated KT. Technology is focused on a certain area and is more “hands-on” [167, p. 4]. Some claim that in knowledge exchange process, TT is only one part of it [168, p. 5]. KT and TT are always connected to one another; diffusion of knowledge will always to some extent occur around dynamic process of TT [163, pp. 2-3]. This research goes along the attitudes which argue that knowledge and technology are not identical constructs and that they encompass different activities; technology is an instrument in function of economic goals, whilst knowledge goes beyond that and is much broader; therefore, breadth of TT construct is narrower [169, pp. 58-59]. One study also discovered that KT embodies TT and that effective TT is inseparable from KT [170, p. 6]. New TT models should emphasize co-creation and co-learning, because learning is mostly bi-directional and mutual [171, p. 12].

### 3.2.1. Commercialization

Through the literature review regarding TT from research community to industry, one of the topics which often appears is commercialization. The focus here will be on basic aspects of it found in scientific literature. Some of the terms which appear the most in scientific literature related to TT are activities, collaborations, technological KT, different Acts, licenses and patents, economic growth and inventions.

TT and commercialization (TTC) assume the **technological knowledge transfer**, application of that knowledge, and that complex process is a matter of policy and management [172, p. 4]. University TT and commercialization activities enhance **economic growth** through creation of job positions and companies related to academic technologies [172, p. 129].

University TT and commercialization **activities** amongst other things include: Research and Development (R&D) resources, infrastructure, licensing inventions, starting up enterprises, finances, entrepreneurial culture and incentives, intermediaries, as well as political, academic and corporate leadership [162, p. 129]. Besides activities, there are also **collaborations** involved in

these processes. One of the main aims of universities became scientific knowledge commercialization through collaborative research [173, p. 134]. University-industry collaboration can be initiated by industries' need for new technology or when new academic knowledge produces certain practical applications [174, p. 1].

When it comes to commercialization, Employees' Inventions **Act** was published in Germany in 1957 in order to provide academic inventors more commercialization opportunities with finances from public funding, but without too much interest, whilst Bayh–Dole Act in USA in 1980 provided a legal framework for patenting with finances from federal grant was very successful initiative [175, p. S14].

In China, patents can be categorized in three groups: design, utility model, and invention patents, but the barriers to technology commercialization are reluctance of industry to invest and the reluctancy of government to publish appropriate policies [176, pp. 4-9]. In Netherlands, SMEs are facing four barriers related to technology commercialization: risk awareness, technological complexity, limited funds, and high market competition [177, p. 122]. **Licenses and patents** are IP commercialization primary medium [178, p. 895]. Contrary to the popular opinion, whether patented technology is exclusively or non-exclusively licensed does not influence publication output nor collaboration with persons who are not related to the license; exclusive university licenses do not reduce diffusion of innovation, idea exchange, nor use for further research [179, pp. 253-254]. “Valley of Death” is the term used for the time period between early innovation product phase and readiness for licensing phase, it is the most fragile period in the patent life cycle because investors have to wait a prolonged time period before seeing the return on their investment [175, p. S14]. Principal Investigators (PIs) have many important roles in multi-stakeholder networks in process of commercialization; negotiating, establishing stakeholder networks and managing them, coordinating, resource finding, evaluating and managing common interests, project managing, as well as Ph.D. mentoring and supervising, and are better boundary spanners between research community and industry - TTOs [173, pp. 134-147]. Also, an important role belongs to Chief Executive Officers (CEOs), whose academic credentials and managerial strategies are positively

correlated to patent propensity [174, p. 1]. Corporate-sponsored **inventions** are more often patented because industry chooses projects which will create patents [180, p. 298].

Commercialization is a very important element of TT. The terms which appear the most in scientific literature related to TT are different activities and also collaborations, technological knowledge transfer, different Acts which allow licenses, patents and inventions, as well as economic growth.

### 3.2.2. Funding

In order for TT to happen, access to funding is necessary. Some of the terms which appear in scientific literature regarding funding in relation to TT are: Foreign Direct Investment (FDI), investment strategies, research funded by the industry, expenditure for research and development, private funding, and investment in innovating.

FDI can provide means for TT and/or technology acquisition [181, p. 55]. FDI knowledge spillovers are significant in direction from foreign subsidiaries to companies in the host countries [182, p. 580]. One of the FDI definitions would be “dominant or controlling ownership of a company in one country (the host country) by an entity based in another country” [183, p. 6].

Economic activity in R&D has a tendency to cluster geographically in areas where it is possible to generate and share knowledge more efficiently; networks between major research community and small businesses are created, which has an impact on **investment strategies** [184, p. 1].

**Research funded by the industry** produces patentable technologies relevant for the industry, which could create economic and social value, yet it reduces professors’ publication, and all these facts are important for policymakers wanting to enhance TT [185, p. 535].

In Croatia, the highest **expenditure for research and development** was in 2004, and in 2012 the lowest, which points to a decreasing trend [183, p. 14]. Some suggest, that in developing countries a partial solution for the financial difficulties around innovation could be **private funding** from technology commercialization [186, p. 16]. Putting in function specialist knowledge providers is positively correlated to **investment in innovating** [187, p. 71].

Funding is paramount for TT to become possible. The terms which appear in scientific literature regarding funding in relation to TT besides investment strategies are FDI, research funded by the industry, expenditure for research and development, private funding, and investment in innovating.

### 3.2.3. Innovation

TT transfer is connected with innovation, so innovation also has a place in scientific literature. Innovation is the product of knowledge and creativity, having an impact on start-up companies and economy in general [188, p. 46]. Many **innovation activities** have been institutionalized, such as the following: establishment of start-up and incubation mechanisms, innovation and entrepreneurship centers, TTOs, science and technology parks, and centers promoting university spin-offs; as well as the concepts like University-Industry Linkages (UIL) and TH [189, p. 18].

**Government sponsored programs** are to allocate public resources for creation of favorable socioeconomic impact, which is paramount for technological innovations benefitting life quality [190, p. 8]. Government policy measures and university management should combine endeavors for turning research into innovation potential, through policy, research and also innovation ecosystem [189, p. 14].

There are also examples of **open innovation networks** like University Technology Enterprise Network (UTEN) founded in Portugal, in 2007, in order to create multistakeholder relationships and provide them with required knowledge. [191, p. 86].

Number of patents and companies' R&D institutes is an indicator which determines **regional innovation level**, whilst intermediary organizational units catalyze the flow of innovative resources such as facilities, personnel and funds [192, p. 15].

Blue Ocean Strategy is an **innovative strategic model**, which suggests that new demand should be created and not fought over by an organization in "Blue Ocean", which is a market space in which a company produces value innovation, simultaneously creates value for the market (both buyer and company); eliminates or reduces negative factors, creates new features and increases them [193, p. 649]. The same source further explains that unlike Red Oceans, Blue Oceans cover all the industries not yet existing, opportunity for growth is abundant, competition is not relevant, and market space potential is unexplored [193, p. 649]. Industrial performance and macroeconomics can be used for observing innovation and TT **effects on sustainable growth** [194, p. 617].

The first academic revolution was marked by institutionalization of teaching in specialized institutions for higher education; the second academic revolution was characterized by universities which combined teaching and research; and the third academic revolution added KT and economic development to universities' mission or in other words combined teaching, research, innovation and at creation of links between university and industry, where universities in close proximity to science and innovation parks create **innovation landscape** [189, pp. 2-15].

Innovation is an inseparable element of TT transfer. Many scientific articles are written on this topic, and mention different institutionalized innovation activities, government sponsored programs, open innovation networks, regional innovation level, innovative strategic model, effects on sustainable growth and innovation landscape.

### 3.2.4. Intermediaries

There are intermediaries in TT processes, just like there are intermediaries in the processes of KT. Intermediaries can conduct TT through the support of both sides in interaction with technical know-how, compatible information, or project management activities [195, p. 485]. Scientific articles mention different kinds of intermediaries in TT processes, and they are mentioned in the text below. Some of the intermediary organizational structures are also **collaborative innovation centers, strategic alliance of industrial technology, and innovation national university science parks** [192, p. 15].

**TTOs** certainly get a lot of attention in scientific literature. Their function is primarily the moderation of stakeholders in processes of technology management [196, p. 1065]. The same research also stressed that the most important indicators showing TTO performance are Funding per one Researcher (FTE), income from contract works, and from international projects; and that motivation systems, number of qualified employees, multicultural environment, TTO staff networking and continuous trainings, trust between scientists and TTO staff, TTO excellent communication skills are all positively correlated with TTO efficiency [196, pp. 1077-1078]. TTOs are also trying to retain entrepreneurial researchers from leaving university, since they are more interested than ever to starting their own company [197, p. 1189]. TTO has a role of the catalyst institution within TH; supports innovation, communication between stakeholders, new technologies and products, supports commercialization, ensuring compatibility of activities, ensuring maximization of socio-economic impact, and improves entire TT process [198, pp. 9-10]. Some argue that since TTOs often cannot generate enough income, **Technology Transfer Alliances** (TTAs) would be a more efficient solution for sharing services, an example of which would be France, where Technological Transfer Acceleration Companies, usually owned by Public Research Institutions (PRIs) and universities, were created in order to reduce TT services fragmentation [187, p. 76].

**Cooperative research centers** (CRCs) promote entrepreneurship, having a focus on social and economic results through science and technology supporting and enhancing, its role and function



having a focus on: networks, brokerage and collaborations; resource appropriation and enhancement; research impact addressing; and enhancement of research quality [199, pp. 3409-3410].

There are also **entrepreneurship research centers** (ERCs) and Entrepreneurship centers (ECs), which also support entrepreneurship, but through different means [199, pp. 3411-3424].

Drafting contracts, negotiating rules, commercializing R&D activities results, partners' mutual understanding, filing the Intellectual Property (IP) registration are some of the **activities** influenced or performed by intermediaries [186, p. 16].

**University technology parks** have the role of incubators; they lower the costs of transforming scientific findings in processes or products, and also help selling them [200, p. 108].

In this process, **TT agent** is also an important; it is a technologist in charge of TT process; finds solutions, studies user needs, creates and tests a prototype, and finally manufactures and sells the final product [166, p. 142].

Intermediaries in TT processes are important entities performing different activities, there are various different ones, just like there are different ones in KT processes. Scientific literature mentions quite a number of them.

### 3.2.5. Models

Business models regarding TT necessitate reinvention in order to survive global competition which is increasingly based on knowledge [187, p. 79]. For that to be done, many new models are proposed, or the enhancements and adaptations of previously existing ones. TT models should alert, search, predict and prepare TT success [163, p. 1]. There is no universal model and all existing

ones have their limits [163, p. 12]. New TT models are necessary for sustainability in rapidly changing global markets [201, p. 1].

**Need to Knowledge (NtK) Model** covers technological innovation process, whilst providing guide for different steps, activities and stages, and is used for program and project evaluating, managing, planning and implementing, to create innovations based on technology, positively impacting sociological and economical aspects [190, p. 8].

When it comes to TT, there are **American and European models**; according to first one, TTO is outside university, and according to second one, it is inside university [196, p. 1065].

**The sustainable innovative academic entrepreneurship process model**, researchers from university have multiple roles and are dedicated to technology commercialization, ensure their personal goals, ensure also socio-economic value and impact on the region, advancement of related companies, ensure technology business value [202, p. 2].

As already mentioned in KT literature review part of the thesis, there is **TH model (Knowledge Triangle)**, where universities and Public Research Institutions (PRI) also contribute to innovation – that is TT [187, p. 71].

There are different **open innovation models**: inside-out model, where companies try to spin out in-house non-core technology, have limited internal potential for technology development, and do outward licensing to companies of all sizes; outside-in model, where companies use many different sources and competences; and the totally open model, where companies interchangeably use the previous two models and are in cooperation and competition with competitors, in order to share risks and also costs, create new markets, or set industry standards [187, p. 74].

Some Higher Education Institutions (HEIs), for example in Israel or Stanford University, formed privately funded TTOs as limited liability corporations, as a more efficient solution [187, p. 77]. The same source mentions that Internet-based platforms allow for advancement of existing internal TTO structures, which France has developed for improvement showcase of technologies developed by PRIs and universities and to the industry; whilst USA is having a discussion regarding **Free Agency model** where researchers could choose between university TTO or some other agent not related to the university [187, p. 77].

**University Technology Transfer Business Model (UTTBM)** was created by the need to transition from TH to QH, and attempts to integrate end users and industry in more collaborative processes, but norms, path dependency and organizational culture of the university will surely have an impact on it [203, pp. 560-465].

In China, there are “**intra-China**”, “**foreign nation–China**” and “**China–foreign nation**” TT models; the first one describing processes involving Chinese research community and industry, and the latter import and export TT processes between China and foreign countries [204, p. 73].

In **subcontracted Innovation Model**, R&D needs of a company are subcontracted to an organization which can fulfill them, weather that is a different company or a member of a research community; **Cooperative Innovation Model (Consortia-Based Innovation Model)** is founded on the necessity to share benefits, knowledge, but also risks in consortium, is very popular amongst EU public administration; **Open Community Innovation Model** is based on open publications and patents, more popular in research community then industry [205, pp. 46-49].

There are many **quantitative TT models**, and some of the most prominent are: Sharif and Haq Model, Raz et al Model, Hamid Jafrieh Model, Technology Valuation Model, Extended Quantitative Model; and qualitative TT models are: Appropriability Model, Bar-Zakay Model, Behrman and Wallender Model, Dissemination Model, Knowledge Utilization Model, Schllie,

Radnor And Wad Model, Sung and Gibson Model, Contingent Effectiveness Model, Five M System Model, Stage-Gate Model, and Role Shifting Model [163, pp. 5-7].

In conclusion, it is to me summarized that scientific literature mentions different business models regarding TT focusing on different TT aspects: NtK Model, American and European models, The sustainable innovative academic entrepreneurship process model, TH model (Knowledge Triangle), open innovation models, free agency model, UTTBM, “intra-China”, “foreign nation–China” and “China–foreign nation”, subcontracted Innovation Model, Cooperative Innovation Model (Consortia-Based Innovation Model), Open Community Innovation Model and different quantitative TT models.

### 3.2.6. Patents

Just like in KT, patents are an integral part of TT processes also. A patent is a legal tool, given by national government agency, which protects and allows promotion of intellectual property right in inventor’s creation, in accordance with patent law, which dates from the 16th century [206, pp. 46-47]. The same source further explains that transfer of property is what the market economy is based on, what is crucial for economic growth are production and innovation, where transforming innovation in commercial value is inseparable from its **protection**; patent holder has a power to transfer the technology, which is embodied in a patent, by granting a license to use in exchange for a revenue share, which are usually royalties [206, pp. 44-45]. One study showed that instead of searching for partnerships with companies, universities are more concerned with protection of the created knowledge, which creates the situation that universities cannot license their patents because companies have no way of becoming ready to use those patents [207, pp. 166-167].

Some of the **reasons for not asking for patent protection** are high costs, fear of disclosure the technology may not be appropriate for patenting; some of the reasons why start-ups are reluctant are refusal to disclose information, cost of patenting and attorneys' fees, cost of enforcing patent and court actions, not strong enough protection or belief that trade secret is enough; belief that technology was not appropriate for patenting [174, p. 10]. Patent protection requires time and

money, and can therefore be considered a bureaucratic barrier to academic entrepreneurship [208, p. 26].

**IP ownership** remains in originating institution, even if the inventor moves to another but if the new institution is interested in the patent it can ask for a license, inventor can ask for IP rights transfer onto him/herself, and if the research is continued at a different institution TTO will step in and negotiate the terms [209, p. 202]. Academics see patenting as a less important **TT channel** compared to publishing and even lesser in terms of production counting [210, p. 74]; in Latin America and Europe it is trade [211, p. 555].

It is an interesting fact that **university patents** are usually basic, corporate patents are usually applied, and Scientists engaged in patenting do not publish less [212, p. 22]. The same source further states that university patenting with non-profit organizations does not lower publication output and increases citation impact, whilst university collaborations with corporations are negatively influencing both impact and publication outcome [212, p. 22]. University scientists who patent also publish more than the ones that don't patent, and tend to shift their research focus to commercial application of their work [213, p. 670]; patenting is positively related to rate of publications and not so much on their quality [213, p. 637].

**Patent analysis** has an important role in innovative process, in gathering information regarding patents in support of: scientific R&D, on a certain technology area; IP protection and procurement, to better formulate legal matters; strategic transactions and business development, to better understand different issues of interest important for decision-making [214, pp. 5-6]. **Imitation** processes are usually regarded as negative phenomena negatively impacting patenting, and positively influencing economic activity; encourage innovative activity, stimulate competition in innovating etc. [215, pp. 265-266].

An integral part of TT processes are patents. Scientific literature mentions different issues related to that topic like: reasons for not asking for patent protection, protection, IP ownership, TT channel, university patents, patent analysis and imitation.

### 3.2.7. Policy

When it comes to defining TT processes, policy documents have a leading role. The most usual topics in the literature regarding TT policy are **IP policy, faculty and staff incentives, and start-up strategies** including rules and support infrastructure [158, p. 6].

**TT policy creation** is process occurring in a fast changing and uncertain environment [216, p. 593]. The central concept in regional policies regarding economic development and innovation became roles of the universities [217, p. 1]. In UK and Sweden, top-down national university policies discourage active commercialization, which especially pertains to spin-outs [217, p. 9].

Policies for institutional and individual **conflict of interest** are necessary, for addressing purchase, clinical practice, research, investments and leadership; since all individual intellectual property at the same time belongs to the institution [218, p. 1340].

In 2008, EC published recommendations for a **Code of Practice** (COP), composed of 18 guidelines (principles in the document) for public research' and universities' KT activities and IP management; 4 for contract and collaborative research, 7 for KT principles, and 7 for IP management [158, p. 4].

**Spin- off policies** emphasize university mentality change, in sense that entrepreneurship could be taught trough courses, experiential learning (i.e., business plan development) and practical training, but to further ease spin-off creation, policy creators should reduce the burden and cost of relevant admin procedures [219, pp. 262-263]. Education objectives are based on training high-quality workforce, academic professionals and entrepreneurs [220, p. 679].

Enhance patenting does not imply an enhancement in knowledge quality because more knowledge does not necessarily imply better knowledge, nor that university is launching the type of knowledge desirable by the local companies, so policies focused on intermediaries in order to match the supply and demand regarding regional knowledge [217, pp. 14-26]. This is one example why the direction of the policy is needed.

Policies are an important element in TT processes which should be given well deserved attention. Scientific literature mentions a number of different ones like IP policy, spin-off policies, start-up strategies, faculty and staff incentives and also issues like TT policy creation, conflict of interest, and COP.

### 3.2.8. Social factors

Social factors are present in most processes, and TT processes also, and are therefore not excluded from scientific literature.

Enterprising aspirations of scientists are strongly and positively correlated with combination of **enterprising norms** and scientific productivity, and also **previous experience** which is domain-specific [221, p. 219].

One study showed that the frequency of scientists' international **mobility** is positively correlated to TT in domicile country, and being static is negatively correlated to TT in home country [222, p. 15]. There is positive correlation between inventor mobility and alliance formation likelihood after inventor movements whilst firm-specific knowledge has a positive impact on development alliance formation (collaboration) and mobility correlation, so placing restrictions on mobility of labor would reduce alliance inter-firm collaboration spillovers [223, pp. 1-6].

**Culture** has an influence on TTO management and internal relationships, TT external stakeholder relationships, and social capital in context of university-industry links- how it is created and utilized, so a culture is an important factor in both domestic and cross- cultural TT [224, p. 133]. The same source further states that those cultural differences influence the choice of the best path to be taken in order for TT to succeed, where social capital has a paramount role [224, p. 141].

Scientists who work for universities which developed policies for **academic engagement** encouragement and which emphasize economic impact are more active when it comes to academic engagement [225, p. 326]. One of the components of the universities' third mission is entrepreneurship education and there have been endeavors to develop academic entrepreneurship through both education and research, which is a long-term innovation system investment pertaining to tech innovation social value creation [226, pp. 801-804].

**Gender issues** are also being mentioned in the TT literature. So, one study discovered that women are better represented in German TTOs than in faculty or academic ranks, which is by both men and women considered a less favorable option but is a result of a maternity leave career break, and are not well represented in more prestigious institutions focused on TT [227, pp. 82-83]. Understanding **personal values, goals and predispositions** of the social capital will help leaders with motivating, managing, keeping their employees, strategy execution and producing a positive social impact [228, p. 1259].

Social factors are an important element of TT processes; articles on the topic of social factors in TT processes mention the following issues: enterprising norms, previous experience, mobility, culture, academic engagement, gender issues and personal values, goals and predispositions.

### 3.2.9. Spin - offs and Start - ups

Spin-offs and start-ups are often products/ side effect of TT processes. Information which can be found in scientific literature regarding TT processes can be seen in the text below.



On the average, the most prominent universities in USA spin out 2.8 new companies per institution every year and in UK 1.3 per institution/year [217, p. 9]. Start-up development is supported by **university incubators** through research and knowledge provision and direct faculty involvement in entrepreneurship [229, p. 1]. Previous research topics regarding spin-offs can be divided in three groups; university prestige in regards to research quality, research funds in nature and amount, and technical resources pertaining to research nature [230, p. 119].

One research showed that university **spin-offs** are significantly and positively associated with the following elements: university incubation services, because they provide services and reduce rental and admin costs for spin-offs; university spin-off activity tradition, because knowledge accumulation activities in the past create opportunity for the university to create spin-offs; the orientation of research, because spin-off activity resembles UI ties; and research funded by the industry, for higher applied research funds are correlated with spin-off endeavors [219, pp. 255-263].

**University–start-up interaction (USUI)** is usually more beneficial to science-based start-ups, and less for universities focusing on fundamental research [220, p. 676]. University spin-offs which are codified knowledge-based often offer products, and the ones based on tacit knowledge often offer services, preferably consulting activity [231, p. 6]. One important aspect to emphasize when speaking about start-ups is **different work speeds** between universities, which are focused on slow generation of accurate knowledge, and start-ups, which have short time cycles and which are oriented towards application [220, pp. 687-688].

**Interdisciplinarity** is favorable for academic spin-offs because of team approach to scientific knowledge, methods and perspectives in order to be further transformed into application-oriented pursuit, and also because academics involved in pursuit have to simplify their scientific communicate, which eases negotiations with external stakeholders and improves commercialization opportunities capturing [232, p. 10].

Scientific literature mentions spin-offs and start-ups in articles related to TT, and elements associated to them which appear are related to university incubators, which elements they have positive correlation with, University–Start-Up Interaction (USUI), issues related to various work speeds and interdisciplinarity.

### 3.2.10. University - Industry Collaboration

UI collaboration enables TT through numerous entities and series of activities with a different focus. **Industry-University Cooperative Research Centers (IUCRCs)** in USA are formed by universities and companies to benefit from formal UI collaboration [217, p. 20].

**UI projects** are more oriented towards finding solutions for technical problems of the companies, prototype development, and finding custom made solutions for the companies, and they therefore result with either less publications or delayed publications because of patenting [233, pp. 1-21]. Some studies claim that university-industry collaboration is more probable if the in question is large, mature, lacks major IP issues between stakeholders, and if internal exploratory R&D exists [234, p. 1].

**Collaborative research** is the most important form of university-industry interaction for creation of university discoveries and for the economic growth creation, which requires adequate IP policies [235, p. 2]. Collaborations between industry and academic community sometimes have issues regarding confidentiality, IP agreements, and different motivations for joint projects where industry wants instant solutions and university aims for publications, and in spite of all mentioned; difficult times act as innovation catalysts [236, p. 839]. Collaborations between industry and academic community which are **teaching- focused** are context-specific management strategy for talents and a good student preparation for R&D positions, while companies may still want to keep model of on-the-job training [237, pp. 12-14].

In scientific literature, UI collaboration is mentioned in context of IUCRCs, UI projects, Collaborative research and teaching- focused activities.

### 3.2.11. Other Technology Transfer Matters

Literature reviews yielded with some other matters regarding TT, which could not be grouped in any of the before mentioned thematic categories. Those are also important to mention, and are mentioned in the text below.

**Absorptive capacity** is an important element for the industry, whilst connectedness is important for both universities TTOs and industry [196, p. 1066]- it is paramount for open innovation [187, p. 73]. Absorptive capacity of a company is a term pertaining to company's ability to draw benefits from external technological discoveries, which is measured by company's investment in Research & Development (R&D) [238, p. 469].

Organizations' **degree of openness** also influences TT between academic community and industry success, and the measure of it is the number of external information channels for innovating: the higher degree of openness of both sides in TT process, the higher chance of knowledge disclosure and also inclusion for their activities [239, p. 9].

In Small and Medium Technological Enterprises (SMTEs), for which key success factor is successful collaboration with suppliers of technology, managers do **risk assessment** taking into account trust, environmental turbulence and current business performance, where trust and turbulence increase willingness to collaborate, and business performance potentially reduces willingness to collaborate [240, pp. 1-6]. There are many TT **barriers** recognized in the literature, and they can be grouped into three different groups: system barriers, technical barriers, and organizational-economic barriers, whilst they can occur at strategic, operational, and tactical level [241, pp. 457-461].

Industry 1.0, the 1<sup>st</sup> industrial revolution, was marked by invention of steam machine and the mechanization of industry, which took a long time; Industry 2.0. or the 2<sup>nd</sup> industrial revolution in 19<sup>th</sup> century and cca 100 years after the first one, was marked by electricity and mass production; Industry 3.0 or 3<sup>rd</sup> industrial revolution, 70 years after the second one, was marked by IT and

process automation; Industry 4.0 or 4<sup>th</sup> industrial revolution appeared cca 30 - 40 years afterwards; and Industry 5.0. or 5<sup>th</sup> industrial revolution is expected soon [20, p. 2]. **Industry 4.0** defines integrated digitalization in a web-based machine and product network and value chain DT, where SMEs are falling behind when it comes to strategies for new solution implementation [242, pp. 985-988]. The premise of Industry 4.0 is that products can be custom made based on customers' individual needs, priced equal as mass-produced goods, and of excellent quality; and it is marked by connection of cyber physical systems (CPS) to Internet of Things (IoT) and digitalization [20, p. 2].

**Internationally oriented companies**, as opposed to domestically oriented ones, have significantly stronger affiliations to different research organizations. [187, p. 71]. **Geographical proximity** of industrial and research entities is a very important factor impacting the speed of innovation [205, p. 46]. License purchasing and Joint venture are examples of TT **strategies** [216, p. 594]. **Agglomerations in form of a cluster** are strongly correlated to research regional universities' results in related scientific fields, especially when it comes to technical fields, high-tech industry and knowledge-intensive services [243, p. 559].

Here, matters related to TT processes also mentioned in scientific literature, which can't be fitter in any of the before mentioned thematic categories are described here, and they are the following: absorptive capacity, degree of openness, risk assessment, TT barriers, Industry 4.0, Internationally oriented companies, geographical proximity, TT strategies and clusters.

### 3.3. Chapter Conclusions

The scientific foundation of this thesis is in KT and TT from research community to industry and vice versa. Scientific literature review was performed accordingly. In this chapter, the clustering of articles by themes came naturally, as certain thematic clusters became apparent as the most usual topics in literature review. Articles discussing KT were researched first, and then articles regarding TT.

Networking part of chapter gave a brief explanation and some basic definitions of elements associated with it in scientific literature: network cohesion, range, size, proximity, boundary spanners, clusters and broader set of knowledge resources. Social capital discussion takes an important part of KT scientific literature. This part of the chapter encompassed the review of the most important elements of it. Those elements are: scientist seniority, cultural differences, autonomy, cross-boundary relationships, academic entrepreneurs, entrepreneurial academics, and finally cognitive and relational social capital. The subchapter discussing TH and QH, which are concepts often found in scientific literature, explains the interconnection of different stakeholders in processes of KT, which have an immense impact on the synergy. Part of the chapter on patenting, gives some explanation on reoccurring themes: absorptive capacity, commercialization and ownership. There are many different kinds of intermediaries in KT processes. There are also many different problems regarding intermediaries about which scientific literature elaborates in much length. They are listed and grouped in clusters. This thesis' focus, amongst many different kinds of intermediaries further narrows down to DIHs. DIH subchapter is one of the most important ones, as it explains the essence of DIHs, which are a special kind of intermediaries in the KT processes from research community to industry and vice versa. These one-stop-shops focusing on DT of mostly SMEs and mid-caps are the main protagonists of this thesis. It is evident from the information provided in EDIH part of the chapter, that EDIHs' and DIHs' definitions, as well as the definitions of services they provide overlap. EDIHs will be considered special kinds of DIHs in this thesis, which in essence they are. The research showed that there are about 50 recognized problems of intermediaries in the processes of KT from research community to industry, which can be clustered in three groups. With that, this subchapter gives a part of the answer to the first main objective of this research. Other TT Matters part of the chapter covers reoccurring themes, which were easily clustered through KT literature review and themes which did not fit into any before mentioned clusters. The most important elements which seem to appear, and which were not mentioned so far are: KT channels, academic consulting, KT activities, knowledge enablers, occupational boundaries, boundary spanners, engaging external engineers, barriers, innovations, collaboration choices, human mobility, highly skilled professions and funding.

In this research, TT will be considered a subset of KT, as it is a narrower concept. Literature review regarding TT from research community to industry and vice versa was elaborated upon.

Commercialization is an important element of TT. The terms which appear the most in scientific literature related to TT are different activities and also collaborations, technological KT, different Acts which allow licenses, patents and inventions, as well as economic growth. Funding is paramount for TT to come to realization. The terms which appear in scientific literature regarding funding in relation to TT besides investment strategies are FDI, research funded by the industry, expenditure for research and development, private funding, and investment in innovating. Innovation is an inseparable element of TT. Many scientific articles are written on this topic, and mention different institutionalized innovation activities, government sponsored programs, open innovation networks, regional innovation level, innovative strategic model, effects on sustainable growth and innovation landscape. Intermediaries in TT processes are important entities performing different activities, there are various different ones, just like there are different ones in KT processes. Scientific literature mentions quite a number of them. Scientific literature mentions also different business models regarding TT focusing on different TT aspects: NtK Model, American and European Models, The Sustainable Innovative Academic Entrepreneurship Process Model, TH model, Open Innovation Models, Free Agency Model, UTTBM, “Intra-China”, “Foreign Nation–China” and “China–Foreign Nation”, Subcontracted Innovation Model, Cooperative Innovation Model (Consortia-Based Innovation Model), Open Community Innovation Model and different quantitative TT models. Patents are an integral part of TT processes. Scientific literature mentions different issues related to that topic like: reasons for not asking for patent protection, protection, IP ownership, TT channel, university patents, patent analysis and imitation. Policies are an important element in TT processes which should be given well deserved attention. Scientific literature mentions a number of different ones like IP policy, spin-off policies, start-up strategies, faculty and staff incentives and also issues like TT policy creation, conflict of interest, and COP. Social factors are an important element of TT processes also; articles on the topic of social factors in TT processes mention the following issues: enterprising norms, previous experience, mobility, culture, gender issues and personal values, goals and predispositions. Scientific literature mentions spin-offs and start-ups in articles related to TT, and elements associated to them which appear to be related to university incubators, whose elements they have positive correlation with, USUI, issues related to different work speeds and interdisciplinarity. In scientific literature, UI collaboration is mentioned in context of IUCRCs, UI projects, Collaborative research and teaching- focused activities. Other

TT Matters section mentions some matters related to TT processes also mentioned in scientific literature, which can't be fitted in any of the before mentioned thematic categories, and they are the following: absorptive capacity, degree of openness, risk assessment, TT barriers, Industry 4.0, Internationally oriented companies, geographical proximity, TT strategies and clusters.

This chapter gives an answer to the following objectives of this research: (1) Identification of factors which influence intermediaries in VD from research community to industry and vice versa, and (2) Identification of DIH similarities and specifics in comparison to other intermediaries.

#### 4. SECOND PHASE EXECUTION: VALUE REPRESENTATION AND PROPOSED DIH REPRESENTATION MODELS

The necessity for this chapter originates in the hypothesis claiming that DIH business model in its essence is a value delivery system model. The value needs to be represented adequately, and that can be achieved through modeling, metamodeling, ontologies, different methods, methodologies, languages and tools. This chapter provides related basic concept definitions, explanations, descriptions and comparisons, as well as explanation why metamodels will be used in this thesis and not ontologies. Also, DIH's (meta)model will be represented through a modeling language, with a visualization tool.

##### 4.1. Basic Concept Definitions

The purpose of this subchapter is to provide definitions of basic concepts necessary for value representation; definitions of modeling, metamodeling and ontologies. Also, information will be given regarding the main difference between ontologies and metamodels, and explanation why metamodeling was chosen for this dissertation and not ontologies.

**Business models** display organization of business components in support of business goals, describe business elements necessary for creation of value for the customers, taking into account business processes, strategy, company architecture and information systems [244, pp. 16-28].

There are different business models, all representing an organization, but from a different point of view [245, p. 19]. Acting as aids in business logic understanding and sharing, they enable easier change implementation in existing business processes, visualize information, encompass different stakeholders' ideas, enhance decision making, enable alternative future simulations and experimentation, adjust strategy and executive elements, and also take into consideration different business model users [244, pp. 33-34]. Unlike process models, business models include high-level complete business description contained in simplistic view [246, p. 106].

**Value models** depict various different business actors, have a contract period and state in which modality values will be exchanged in the given timeframe, whilst representing consumer needs, also showing which transactions and which logic will meet them [14, p. 2]. They show actors exchanging economic value with each other, and are different from process or activity models which depict who exchanged what; process models depict how it was done, and activity models depict activity flow [15, p. 119]. What they also display is how the creation, delivery and business value capture occur in an entity, through the concept of “economic exchange”, all in order to perfect business strategies with goals and IS [247, p. 1].

International Organization for Standardization (ISO) standard ISO/TR 9007:1987 named “Information processing systems — Concepts and terminology for the conceptual schema and the information base” came out in 1987 and defined conceptual schema [248], which is favorable for metamodeling due to simplicity of notation and flexibility of metalevel knowledge representation [249, p. 245]. One could conclude that that was when the metamodeling got its momentum. Metamodeling is a technique for using a model to describe another model, whilst having the ability to define properties of model classes [250, p. 300]. It is used when a model can have different roles in an application and also to imitate capabilities of other modeling systems [250, pp. 300-301]. And the reason we build models is for the reasons of risk management, reality simplification, and system understanding [251, pp. 16-18]. Model of the model is a metamodel, and the purpose of it is modeling models, as well as arbitrary metadata, where two layers (metalevels) is the required minimum [252], whilst the maximum number is related to the useful level of abstractions [253]. Metamodels purpose is the implementation of model transformations and creation of Domain Specific Languages (DSL) [254, p. 5457].



OMG as an international technology standards consortium [255], proposes architecture in four conceptual levels of a model; Layer M0 for Instances, Layer M1 for models of the system, Layer M2 for models of the models (metamodels), and Layer M3 for models of M2 (meta-metamodels) [256, pp. 7-8]. Metamodel is created with the modeling language, called metamodeling language [253, pp. 2-3]. OMG provides specification for MOF, a metamodeling mechanism used for defining UML metamodels [257, p. 336]. It allows for models to be: stored, transported between different applications, retrieved, modified into different formats, and used for application code creation [39]. OMG also creates specifications for Model Driven Architecture (MDA) implementing applications, including UML specification [255], which is a language for specification of object-based modeling languages [256, p. 7].

One definition of an ontology is the following:

The subject of ontology is the study of the categories of things that exist or may exist in some domain. The product of such a study, called an ontology, is a catalog of the types of things that are assumed to exist in a domain of interest D from the perspective of a person who uses a language L for the purpose of talking about D. [258].

So, from this definition, it is evident that the ontology focus is on the categorization and on the domain, whilst the result is the catalogue of elements in a domain. Model represents only a specific domain portion [259].

A very important difference between ontologies and models are so called open and closed world assumptions. Ontologies are under open world assumption, which states that: “a statement cannot be assumed true on the basis of a failure to prove it” [260, p. 25]. This means that all that is not expressed explicitly, an ontology considers to be unknown [261, p. 256]. Most of the system models are under closed world assumption [261, p. 256], which states that: “a statement is true when its negation cannot be proven” [260, p. 25]. Put in different words, that means that all that is unknown to be true is considered to be false [262]. The reason that models are under closed world assumption, is the need for reduction of inconsistencies through restriction of the system arbitrary extensions [261, p. 256].

When speaking about categorization, ontologies deal with real-life objects, where three levels of element coupling can be applied, whereas metamodels deal with well-established abstract knowledge [263, p. 23]. The same can be stated in a different way, and that is that ontologies deal with descriptions of reality, whilst models are concerned with artefact specification [261, p. 253].

It should be emphasized that most models for software design and development create templates for system implementation, which makes them prescriptive, whilst ontologies are descriptive types of a model [261, p. 257].

Yet there are advantages for both approaches; joint use of both metamodeling and ontologies can be very useful for stabilized description of complex domain's domain knowledge, where ontologies work great for stabilized business domain descriptions and metamodels for domain fine description in modeling initial phases, not necessarily stabilized [263, pp. 21-22]. This leaves space for potential future research regarding DIHs.

So, in conclusion it can be emphasized, that in the domain of value delivery, this thesis is not dealing with cataloguing its elements, but rather with representing DIH, a part of that domain. For DIH, models and a metamodel will be built, and the closed world assumption will restrict their arbitrary extensions. In that process, artefacts will be specified and RMM will be prescriptive, meaning that it will show what all a DIH has to be composed of in order to be called a DIH. It is also important to stress that specification models in their focus have generation of systems, specification and control [261, p. 258], and that is precisely what DIH RMM will be utilized in future; for the design of DIH information systems. All the above-mentioned arguments support the decision to use metamodeling for DIH RMM design.

## 4.2. Concept of Value

At the very beginning, it would be interesting to mention the etymology of the very word "value". It originates from the Old French word "valoir", which literally means "be worth" (implicitly) of usefulness, worth or importance, and that lies in the very essence of everything an organization

does- provides value to stakeholders, which then forms a business model [264, p. 1]. VDMbee defines value as “a measurable factor of benefit delivered to a recipient in association with a deliverable” [265].

Peter F. Drucker, the founder of management as a formal discipline, states that business creates value for the customers and wealth for the owners [266, p. 55]. Value for the customers is studied in the field of marketing. In scientific literature, there is no unified definition of the value concept, but there are articles discussing the subjectivity of value, value measurability, value with different dimensions, value in terms of competitiveness, value in terms of benefits and costs, value triad, value offering, dynamics of value, value components, value co-creation and customer perception [267]. Value, from customers’ perspective, encompasses all the benefits a customer gets from the vendor for the money invested [268, p. 6], whilst companies rate customers’ value through loyalty [269, p. 78].

Customer experience is also a concept often mentioned when speaking about value; it states that the value which a customer perceives consists of both products as well as services which a company delivers and also in the way how they are delivered, impacting customers’ holistic view of value received [270, pp. 21-22]. This is therefore a more complex view of the value concept. A study should be mentioned, which showed that for cellular service provider, main determinants of customer experience are the experiences with: network (the highest impact), billing, brand image, customer care, service delivery, web self-service and store gallery; whilst main parameters for network experience are: call connectivity and quality, indoor and outdoor network coverage and data experience [271, p. 2043].

The Institute of Value Management clearly states that value can be many different things, and is defined by the needs needing to be satisfied [272]. BS EN 12973:2020 is a British Standard for Value Management, drafted by Technical Committee CEN/TC 279 “Value management, value analysis, function analysis” coordinated by BSI, a standard which also Croatia is on a list of countries bound to implement it [273, p. 5]. The standard defines organization’s value management

as proactive value increase, in terms of need satisfaction and resource consumption in that process; the greater the disproportion of those two, the bigger the value [273, p. 6]. Value is at a very core of trade [274, p. 19].

When speaking about Business Architecture, the concept of value is to be regarded as desirability, advantage, usefulness or benefit; non-monetary value examples would be up-to-date information access, product or service successful delivery and client's problem timely resolution [264, p. 1].

DT is a change process which pertains to organizations starting to create value through Information Technology (IT) usage aligned with the business processes [14, p. 1]. The technologies with the highest DT impact such as IoT, High performance Computing (HPC), Block-Chain, AI and Robotics; are not exploited enough by EU [275]. The same source also warns that the intensity of DT in EU is too heterogeneous [275]. DT is a very important concept because it revolutionizes the way business used to be done, introduces the new living and thinking paradigm, introduces novel organizational structures and models, and allows work to go about seamlessly [40]. So, DT and related technologies can be considered an added value for the companies.

It is evident that value can take many different forms in terms of benefits of all sorts for a company or a customer. One of those benefits can also be knowledge. To support that statement, it is worth mentioning an article about healthcare system as a value, suggesting that wealth and health are positively correlated, and that healthcare system is a major factor in generation of wealth, putting in focus health librarians, core actors of that system [276]. To conclude, value in this thesis will be considered knowledge and/or technology which is transferred in support of DT.

### 4.3. Value Methods and Methodologies

This subchapter gives some definitions and descriptions of different value methods and methodologies, explaining what they are used for, which elements they consist of and what they result in.

**Value-Driven Development method** (VDD) is used for creating software architecture in accordance with economic value through modeling techniques, and which has three phases: performance of business analysis, specification of requirements, and finally derivation of software architecture specification, and software architecture derivation [274, p. 20].

A group of authors compare Dynamic Value Description (DVD) and e<sup>3</sup>value methods, but also mention different other scientific work related to comparison of other business value modeling methods, amongst which Business Model Ontology (BMO), Resource- Event- Agent (REA), iStar (i\*) and Collaborative Value Networks (CVN) [274]. Those methods, and some other, will be further elaborated in the lines which follow underneath this intro passage.

**e3value method** is used for modeling exchange of value objects between network of customers and organizations, where each party engaged in transaction receives at least one value object; an economical transaction [14, p. 2]. This method could be used for considering the potential for profitability of innovative e-commerce ideas, in the value-based requirements engineering phase one; yet unknown products withholding economical value proposition, and which are based on IT, often initially not very well articulated, which makes design of IT in support of it difficult [15, pp. 114-116]. The same source claims that it indeed is based on requirements engineering and conceptual modelling [15, p. 115]. e3value ontology is composed of the following elements “actor, value object, value port, value offering, value interface, value exchange, market segment, composite actor, and value activity” [15, pp. 119-121]. Tools available for e3value are E3web tool, E3fraud tool, Blockchain decision tool, and Security Risk Management Framework decision tool [277]. This method will be discussed in further detail in one of the subchapters below.

SEAM is acronym for the **Systemic Enterprise Architecture Methodology** addresses seamless integration of IT and business [278], just like e<sup>3</sup>value, model services focusing on the exchange of value in networked systems, yet they conceptualize value differently; SEAM takes into account the subjective aspect of value and construction of value propositions of different importance [279]. Since SEAM is not able to represent big systems and Zachman Framework, the most popular enterprise architecture framework, it can be used for accessing a number of smaller models represented by SEAM [280]. SEAM models behavior and also analyzes behavior in a network of suppliers which through collaboration provide value, resulting in service system, all through a

service-oriented language [279]. SEAM focuses on multi-level: design, modeling, and deployment; while also including Computer-Aided Design (CAD) prototype tools for supporting enterprise architecture [278].

This subchapter provided an overview of the following value methods and methodologies: Value-Driven Development method, e3value method and Systemic Enterprise Architecture Methodology. The following one will discuss value ontologies in more detail.

#### 4.4. Value Ontologies

Even though metamodeling was chosen as a method to be used in these theses, as was already explained, some value ontologies will be briefly described in this subchapter. Even though they were not chosen for this thesis, it is still important to mention them and give some examples, since they are also an important element associated to the value concept.

**REA ontology**, unlike e3value, does not contain value activity element, so it is not the optimal approach for business development [15, p. 131]. This ontology has roots in accounting, but it is not only for accounting [281, pp. 124-125]. REA accounting model is named after its main economic components (resources, events and agents) [282, p. 556]. REA conceptual model supports registration of all money and product flows, internal and external to the company [281, p. 126]. This ontology was the basis for ISO/IEC 15944-4:2007 standard, which concerns transactions in Open-edi Business Transaction Ontology (OeBTO) [283], through integration of REA and Open-edi concepts in order to create collaborative business transactions specifications [246, p. 107].

**AIAI Enterprise Ontology (AIAI EO)**, a business modeling ontology, which unlike e3value, takes into consideration that only two goods can be exchanged in transaction, a value exchange, and does not consider transactions between numerous parties [15, p. 131]. This ontology focuses on business processes inside company, unlike e3value [284, p. 270]. It has four main subdivisions: organization, activities, marketing and strategy, whilst knowledge is a resource taking part in different activities [285, p. 43]. It was developed by Artificial Intelligence Applications Institute of University of Edinburgh as a part of Enterprise Project, whose purpose was to provide enterprise modeling framework [286]. The same source claims that the beforementioned framework was supposed to

be based on Enterprise Ontology, which was meant to contribute to human communication enhancement, flexibility through Enterprise Tool Set usage, and provide interoperability amongst disparate tools also through Enterprise Tool Set, whose main components are Agent Toolkit, Procedure Builder and Task Manager [286].

**Toronto Virtual Enterprise Ontology (TOVE)**, developed by University of Toronto, is another business modeling ontology, but unlike e3value, whose focus is on external exchange of value in a network, focuses on internal workflow [15, p. 131]. This ontology focuses on agile enterprise elements like behavior, structure and information, but value creation, distribution and consumption in external consumer network is not taken into consideration [284, p. 270]. It would integrate knowledge valuation ontology through various different ontologies and visualizations in a company [285, p. 43]. So, the main objectives of TOVE project were to create a common-sense enterprise model representation through clear definition of terms, symbology definition and standard terminology [287, pp. 3-4]. For the previous TOVE version called CARMEMCO Knowledge Craft<sup>R</sup> tool was used, and for today's version ROCK<sup>TM</sup> knowledge representation tool [287, p. 8].

**BMO**, developed by Alexander Osterwalder as an ontology for representing business models, is composed of four pillars and nine building blocks, and amongst those building blocks is also Value Proposition, everything a company has to offer as a value to the customer, and Value configuration, which describes resources and activities necessary for value creation [288, pp. 58-59]. BMO has a specific business entity, in e-Business network, and a way of making profit in focus, taking internal perspective into consideration [289, p. 1].

**BMC** by Alexander Osterwalder and Yves Pigneur is the most popular business model developing and visualizing tool, and is based on BMO [16]. BMC will be discussed in further detail in section 5.3.1.

There is also **e-Business Model Ontology**, which gives basis for e-business tool development, with focus on value development in the Internet era, and which is based on infrastructure management, customer relationship, product innovation and financial aspects [290].

Value ontologies, even though they were not chosen as a method for this thesis, were given some attention in this subchapter. Those value ontologies are: REA ontology, OeBTO, AIAI EO, TOVE, BMO, BMC and e-Business Model Ontology.

#### 4.5. Other Value Associated Matters

There are some other matters associated to value concept, which could not be classified into any previously mentioned subchapters. Those matters should be mentioned as well, and they are briefly described in this subchapter.

One important concept to be mentioned here is also **value-based requirements engineering**, since some of the methods described below are based on it. With this approach, IT value proposition can be elaborated in further detail, taking into account economic value of developing IT-intensive products [15, p. 116]. Generally speaking, value proposition addresses products, services, jobs and experiences which customers deem as valuable, as well as impact of the brand onto customer and interaction with the customer [291, p. 14].

DVD is a cognitive requirements approach, used in the business analysis VDD phase, which has economic value exchange in focus [274, p. 2]. It contains the following main concepts “environment actor and main actor (from whose relationship the exchange of value is conducted), the one who starts the value exchange, the actual value exchange, value level agreement, value element, value port, and priority of value exchange” [274, pp. 20-21]. DVD is more effective and efficient than e3value is business modeling from economic perspective i.e., value specification [247, pp. 2-11]. Reference Architecture Modeling in an Agile software development (RAMA) is a method which encompasses business values as well as agility in developing software in focus, which in one research implemented DVD editor through Eclipse

i\* 2.0 is a goal-oriented language, which evolved from conceptual modeling language i\* focused on why, who, how and how else questions posed in business processes [292, p. 1]. i\* models display strategic thinking which support the exchange of value in e3value models [293, p. 30]. i\* 2.0, introduces two types of actors; Role and Agent, different predefined associations, intentional elements like Resource, Quality, Task and Goal, and also different kinds of predefined



dependencies, rules and restrictions, NeedBy relationship linkages, Contribution linkages, qualification relationships and model views [292, pp. 5-12]. Some of the tools using i\* 2.0 and or i\* are piStar [294], T-Tool [295] and Organization Modelling Environment (OME) [296].

**CVN** is the concept which came out of manufacturers efforts for collaboration improvement throughout the whole value network ecosystem, and CVN extends and compliments ARC Advisory Group's Collaborative Management Model (CMM) depicting an endeavor for all involved parties to seamlessly collaborate through design (engineering, construction, making (purchasing, production network, supplier network, distribution) and delivery (service, retail, service, customers, logistics) [297]. In collaborative value chains, determining "value added" by each participant and collaborative networks try to maximize a chosen component of value system is difficult [298, p. 2]; it depends largely on the value system on which each context is based [298, p. 11]. CVNs require alignment of customer value proposition and value delivery [299, p. 217].

Web based technologies called for **e-Value Network Management models**, advances in ICT had an impact on value chains in organizations, supplier communication goes through central platform, and so eCollaboration incorporates participants through value chain and is based on Web [300, pp. 1737-1738]. Enterprise Interoperability Ontology (ENIO) could be a solution to providing common understanding of processes, services and data in integration scenarios of business-to-business a.k.a. enterprise alliances sharing skills, resources or competences [301, p. 539].

**EuGENia tool** [254, pp. 5455-5459]. Eugenia tool allows creation of graphical model editors based on Graphical Modelling Framework (GMF); it automatically generates different models from one annotated Encore metamodel for GMF editor [302]. GMF Tooling framework, is not actively maintained anymore; more actively-maintained tool is Eclipse Sirius [302].

There are many other methods and also tools for value modeling. One of the tools is OMiLAB's Bee-Up, hybrid modelling tool based on ADOxx metamodeling platform, and which encompasses modeling languages like Business Process Model and Notation (BPMN), Event-driven Process Chains (EPC), Entity Relationship Diagrams (ER), UML, Petri Nets, and some other auxiliary ones [303]. It is worth mentioning that ADOxx is development and configuration platform for developing

modeling tools [304]. Some of the examples of modeling approaches realization cases are BPMN@ADOxx, UML@ADOxx, OWL@ADOxx, ER@ADOxx and EPC@ADOxx [305].

One of conceptual modeling languages, often used in specification documents for visual metamodel representations is **UML** [306, p. 1]. UML development started in 1994, as standard modeling language for software blueprints and for modeling systems [307, pp. 12-22], 1.3 being the first mature version [308, p. 36]. It is defined by MOF and nowadays, with its extensions for different domains which are grouped into profiles, is the most common standard for information systems specification and documentation [309, pp. 6-7], and also for software blueprints [251, p. 21]. Those profiles, predefined in terms of tagged values, constraints and stereotypes, can be reused in any application, customize any MOF metamodel and specify another UML profile [309, pp. 8-9].

Business modeling recommends alignment of solutions proposed by ICT and business needs, and implies mapping business model into information system infrastructure, in order to provide value to the customer, who establishes whether the value has indeed been created [310, pp. 11-16]. UML, as a visual language for specifying and documenting information systems, contains extension mechanisms for modeling specific domains, amongst which are also UML profiles [256, pp. 6-7]. One of those profiles is VDML, with the purpose of creating business design models, which connect corporate business strategic and operational level, for improving everyone's business transformation understanding [12]. It is a language for conceptual models for designing and analyzing value creation [311, p. 2]. In the case of this research, that would be DT of the businesses. VDML has value chain in focus, as well as the complex collaborations and business networks, different kinds of activities and roles, but also capabilities [12]. Value modeling is used for presenting both creation and exchange of values [13], which in this case also means KT.

The common characteristic of KT and VD is that they both focus on transferring or delivering, which can be considered a synonym, of some kind of value. What makes them different is the fact that KT focuses on knowledge as a value specifically, whilst in VD value can be defined as many different things.

**VDML** is a standard modeling language with focus on value exchange and creation; VDML metamodel was created in support of value stream, value chain, capability analysis, VNA, REA analysis, role-based interactions, owner/investor business model, human collaborations modeling and e<sup>3</sup>value modeling [265]. VDML viewpoints can be seen on Fig. 5. below.

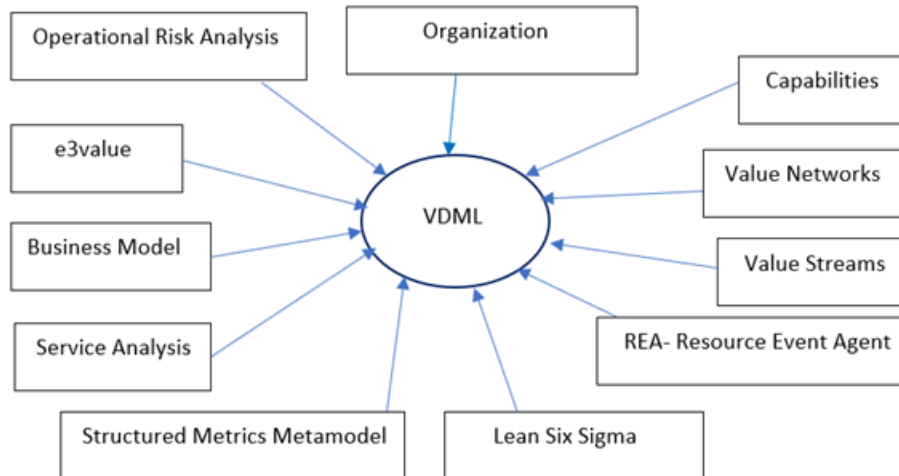

Fig. 5. VDML viewpoints. Source: VDMbee [265].

In conclusion, it can be summarized that some other matters which did not fall in any of the previously mentioned categories are mentioned in this subchapter, and they are: value-based requirements engineering, DVD, i\* 2.0, CVN, e-Value Network Management models, EuGENia tool, Bee-Up, UML and VDML.

## 5. THIRD PHASE EXECUTION: ANALYZING DIH'S BUSINESS MODEL WITH VDML AND DIH REPRESENTATION

This subchapter briefly explains why DIH's (meta)model be analyzed with UML's VDML profile, and how it will be visually represented with Visual Paradigm graphical editor. DIH (meta)model is represented on different conceptual levels, in order to be understandable for wider audience.

Analyzing DIH's Business Model with VDML follows the logic; if DIH is an organizational unit which creates and mediates in processes of value transfer, its business model and operations should be describable by VDML [40]. All before mentioned OMG proposals and specifications provide an argument for its utilization in creation of DIH RMM proposal design. Under the pretenses that DIH in its essence is a VDS, value being KT from research community to industry members seeking help with digitalizing their businesses, and vice versa, it should be possible to explore conformance of the following concepts; those underlying DIH and of VDS. The hypothesis then is that business model of a DIH is a VD, and as such it is possible be map onto VDML metamodel, which would contain all the meta-information about a DIH model and the mapping, to explore its DIH RMM suitability. That could be established through the proof of DIH RMM with VD metamodel (part of the VDML specification [12]) conformity. DIH RMM would be a concept, which would later down the line be able to generate new DIH models. DIH characteristics which make it suitable for VD models, are its structures and relationships that can be mapped onto VDML metamodel subset; classes defined by OMG [12].

In order to depict DIH model, a tool needed to be chosen. For that purpose, Visual Paradigm tool was considered adequate. Visual Paradigm Online offers a whole suite of tools encompassing Visual Designer, Diagram Creator, Flipbook Maker, Collage Maker, Photo Book Maker, Chart Maker, Form Builder, Spreadsheet Editor, Document Management, Collaboration, Share and Publishing, Admin and Security, and Image Background Remover [312]. DIH model cognitive levels 0, 1/1 and 1/2 were depicted in Visual Paradigm Diagram Creator tool, Community Edition, version 16.3. Level M0 is a free style real life depiction of elements related to DIH, based on the DIH literature. Levels M1/1 and M1/2 were depicted in the form of UML class diagrams.

So, in conclusion, since DIH business model in this research is considered a VD, it could be mapped onto a VDML (meta)model, through UML's VDML profile. Visual representation of DIH VDML (meta)model on M0, M1/1 and M1/2 conceptual levels is displayed through Visual Paradigm tool.

## 5.1. Different Cognitive Levels of DIH Model Representation

Firstly, different cognitive levels of DIH model representation will be created. M0 cognitive level of DIH model representation will be created as a free style diagram. M1/1 and M1/2 levels of cognitive DIH model representation will follow.

### 5.1.1. M0 Cognitive Level of DIH Model Representation

As already stated, Level 0 is a free style diagram depicting real life elements related to DIH, and it represents a starting point in visualizing the final artefact of this thesis. The diagram on Fig. 6. below is based on the available DIH literature listed in Appendix 6.

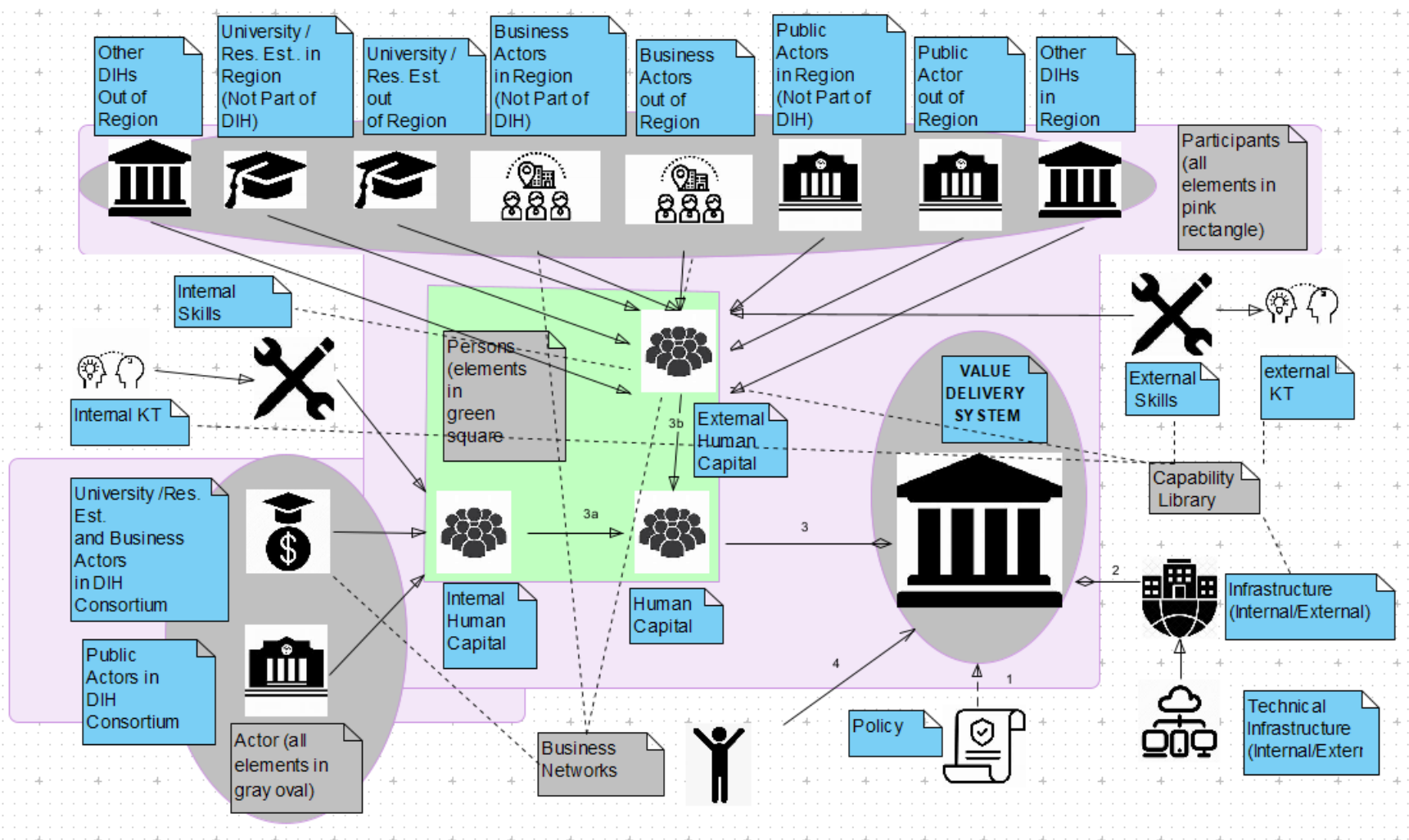

Fig. 6. M0 Cognitive Level DIH Representation.

DIH M0 cognitive level visualization basic elements in words would be the following:

1. DIH's work, a work of VDS, is defined by different **Policies** [113, p. 5].
2. DIH is an aggregation External **Infrastructure** [112, p. 10], a part of which is also Technical Infrastructure and of Internal Infrastructure.
3. DIH is also an aggregation of **Human Capital**, which is comprised of:
  - a) Internal Human Capital [93, p. 28], which encompass the following-
    - Internal Skills [93, p. 28] (a part of which is also KT),
    - Business Actors (in DIH Consortium) [93, p. 28], and University/Research Establishments;
    - Public Actors in DIH Consortium [93, p. 28];
  - b) External Human Capital [93, p. 28], which encompass the following-
    - External Skills (a part of which is also KT),
    - Other DIHs out of Region [117, p. 28],
    - University and Research Establishments in Region [93, p. 28],
    - University and Research Establishments out of Region [93, p. 28],
    - Business Actors in Region (Not Part of DIH) [93, p. 28],
    - Business Actors out of Region [93, p. 28],
    - Public Actors in Region (Not Part of DIH) [93, p. 28],
    - Public Actors out of Region [93, p. 28], and
    - Other DIHs in Region [93, p. 28].
4. **Client**/customer comes to DIH to ask for a service.

Also, members of Participants class are all elements in pink rectangle, elements in green square are members of Persons class and members of Actor class are all elements in gray oval.

### 5.1.2. M1/1 Cognitive Level of DIH Model Representation

M1/1 Cognitive Level of DIH model representation will be represented in this subchapter. It will be created in accordance with DIH literature, taking into account all beforementioned elements already mentioned above, and then those elements will be placed in different classes, in accordance with VDML specification [19] and presented as UML diagram. The storyline would then be the following:

1. DIH functions in the way that clients/customers get preliminary information about DIH. That can happen through social media channels, DIH web page or through newsletters [116, p. 17]. On this representation, DIH Web Page will be displayed.
2. DIH's web page contains all the relevant information about DIH; an entire service portfolio description (matchmaking, KT, TT, training, mentoring, business plan proposal, advise proposals etc.); DIH's **Value and Value Proposition** are described there.
3. DIH's services have primarily SMEs in focus [113, p. 1], but Client/customer can be a private **Person** (human **Actor**) or legal entity (**OrgUnit**) which after for example seeing DIH's web page decides to visit DIH in order to pursue one of the options from DIH portfolio.
4. **Persons class** will be composed of the following elements: Human Capital- Internal Human Capital and External Human Capital [93, p. 28]; and a Client/customer.
5. Client/customer then interacts with DIH's staff (Internal Human Capital); the interaction is initially in the form of a meeting (**Activity**), a conversation regarding the client's/customer's issues where DIH's staff is trying to offer the best possible solution within their premises.
6. In case that DIH's office cannot help the client/customer with their own Internal Skills and Internal Infrastructure, they engage other entities out of DIH office which **Collaborate** also with DIH (External Human Capital), in order to rely on the(ire) External Skills and External Infrastructure.
7. According to OMG's VDML specification, multiple **Participants** (human/non-human **Actors** or another **Collaboration**) take part in collaboration [19, p. 13] through different Roles.



8. Through this collaboration of different participants available to DIH, the best possible solution (**BusinessItem**) is found or custom made for the Client/customer.
9. **Participant class** will be composed of the following elements (drawn in pink rectangle): DIH; University/Research Establishments and Business Actors in DIH Consortium; Public Actors in DIH Consortium; Other DIHs out of Region; University and Research Establishments in Region; University and Research Establishments out of Region; Business Actors in Region (Not Part of DIH); Business Actors out of Region; Client/customer; Public Actors in Region (Not Part of DIH); Public Actors out of Region; and Other DIHs in Region.
10. Based on OMG's specification, Participants take part in collaboration, through their own one or more assigned **Roles** [19, p. 17]. So, an entity which comes to DIH asking for help as a Client/customer (with a Role of Client/customer), is also a Participant directly involved in Collaboration.
11. Based on OMG's specification, every participant can belong to many collaborations (not only one) [19, p. 14].
12. **Actor class** will be composed of the following elements (drawn in pink rectangle): DIH; University/Research Establishments and Business Actors in DIH Consortium; Public Actors in DIH Consortium; Other DIHs out of Region; University and Research Establishments in Region; University and Research Establishments out of Region; Business Actors in Region (Not Part of DIH); Business Actors out of Region; Public Actors in Region (Not Part of DIH); Public Actors out of Region; Client/customer; and Other DIHs in Region.
13. **Actor** and **Participant** are influenced by **Policy /Strategy**.
14. According to OMG's specification, Collaboration is composed of one or more **Activities**, each performed by one Role in Collaboration [36, p. 14]. In DIH collaborations, which are often comprehensive activities, usually involve a sequence of activities before the final solution is found/created.
15. According to OMG's specification, one Role may perform more than one Activity and if they require different **Capabilities**, Participant should be able to cover them all [19, p. 18]. For those Capabilities, DIH first looks for in Internal Skills and Internal

Infrastructure, and if they cannot be found there, then in External Skills and External Infrastructure.

16. All the capabilities that DIH has to offer are in **CapabilityLibrary** class, so it will be composed of the following elements: internal KT, external KT; Internal Skills; External Skills, Internal/External Infrastructure; and Technical Infrastructure.
17. According to OMG's specification, Participant is involved in Activity by doing an *Assignment*, which determines how a Role in a particular Collaboration is to be fulfilled [19, p. 34]. So, a customer's assignment would be to obtain the solution.
18. According to OMG's specification, **BusinessNetwork** is Collaboration of *Parties*, which identify roles in business networks [19, p. 14]. On the representation, Party is through Role associated with Collaboration, which is associated to BusinessNetworks.
19. Parties in case where DIH cannot find a solution for the Customer within its own premises would for example be infrastructure provider, funding provider, knowledge provider, legal advice provider etc.
20. According to OMG's specification, Community is a collaboration of Participants, where a role is identified by *Member* [19, p. 45].
21. Different communities may also be formed from members of DIH's Internal Human Capital or External Human Capital, in order to reach a specific solution through collaboration.
22. According to OMG's specification, Role in OrgUnit is identified by **Position** [19, p. 46].

M1/1 Cognitive Level of DIH Model representation depicted can be seen on Fig. 7. Below, which is based on DIH literature and OMG's VDML specification [35].

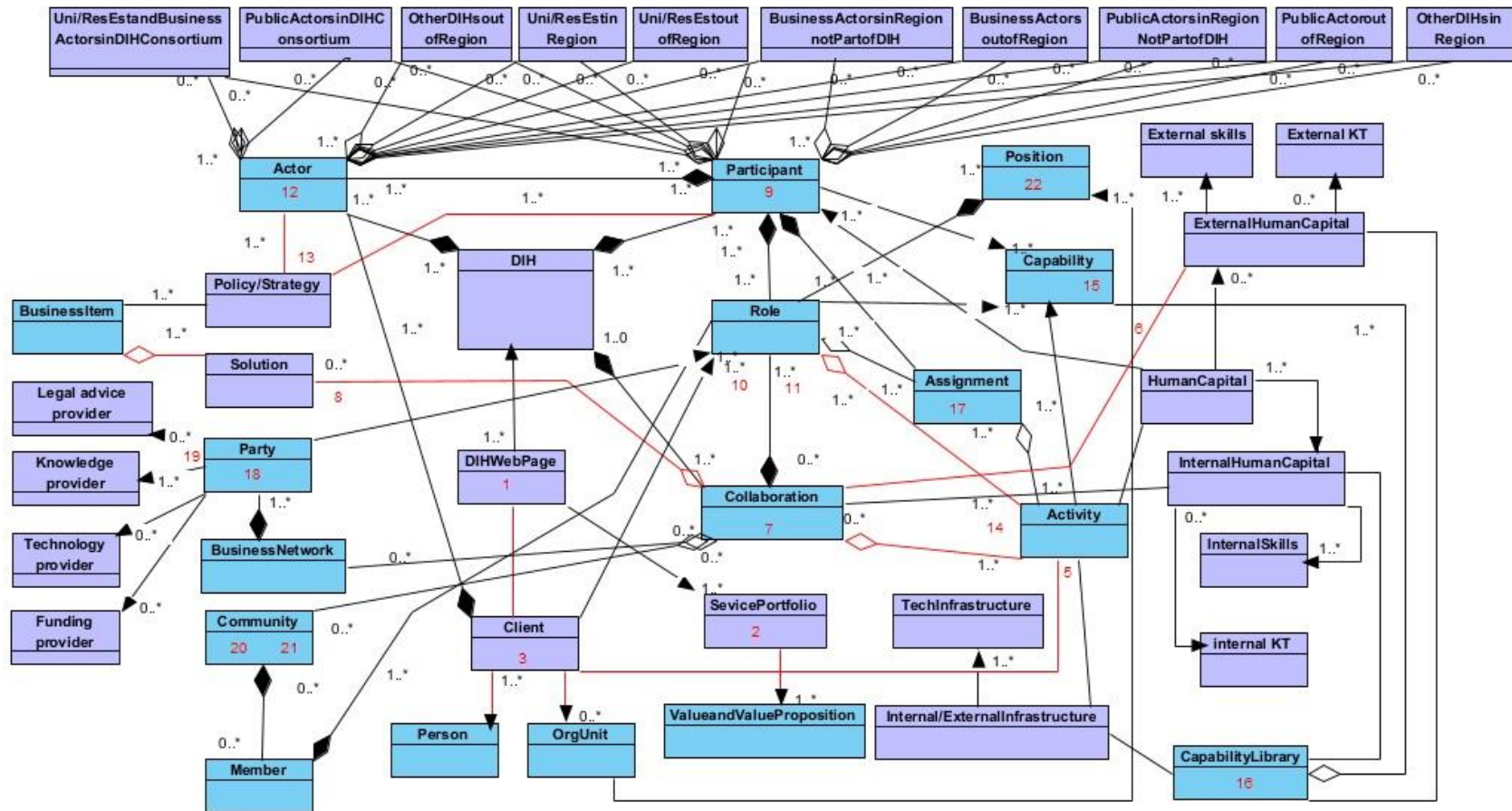

Fig. 7. M1/1 Cognitive Level of DIH Model Representation as a UML Class Diagram.

Blue elements are the ones which can be found as classes in VDML specification [19]. Purple elements are the ones recognized from DIH literature, for which an exact class cannot be found in the specification but can be associated with predefined classes. All of those elements were interconnected in accordance with the storyline.

### 5.1.3. M1/2 Cognitive Level of DIH Model Representation

M1/2 Cognitive Level of DIH Model representation, in accordance with VDML specification [19] and DIH literature, the storyline would be the following:

1. Based on OMG's specification for metamodeling conformance, DIH metamodel in VDML has to contain the prescribed 22 metaclasses [19, pp. 3-4], which are metaclasses on the M1/2 Cognitive Level of DIH Model representation will be depicted in gray color.
2. **ValueDeliveryModel** metaclass is DIH Metamodel. This was not represented on M1/1 Cognitive Level of DIH Model representation.
3. According to OMG's specification, **VDMLelement** metaclass is abstract class containing primary model elements [19, p. 55]. This was not represented on M1/1 Cognitive Level of DIH Model representation.

Elements of M1/2 Cognitive Level of DIH Model Representation described in steps 1., 2. and 3., based on VDML specification [19] are depicted on Fig. 8. Below. Those elements have to be associated to each other in a way that resembles associations in M1/1 and also in accordance with beforementioned specification.

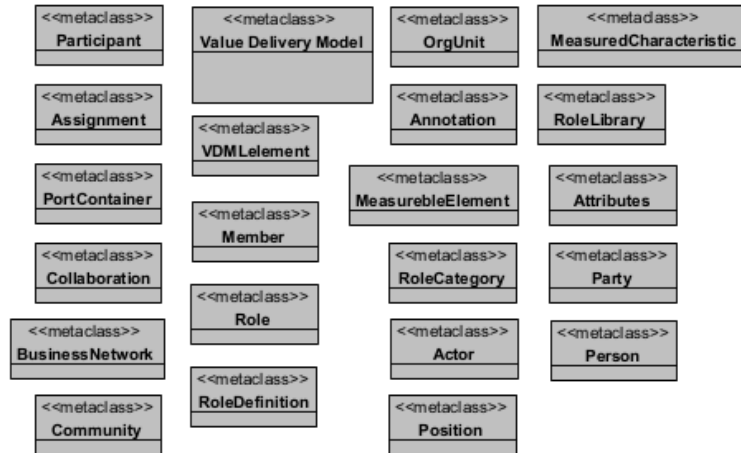

Fig. 8. OMG's Metamodeling Conformance Metaclasses.

4. Elements which are not one of those 22 prescribed metaclasses, but which are VDMML classes recognized in DIH literature, will be marked in blue; one of them is **ValueandValueProposition** metaclass, which contains amongst other things DIH's web page with DIH portfolio, explaining all the value offerings. On the Fig. 7. above, this logic would pertain to part of the figure depicted on Fig. 9. below, based on OMG's VDMML specification [35]:

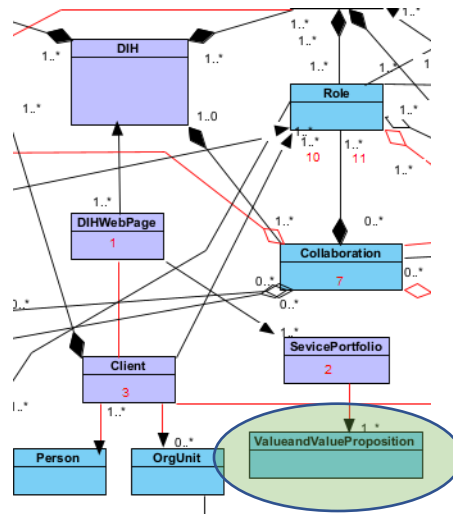

Fig. 9. M1/1 Cognitive Level of ValueandValueProposition Class in DIH Model Representation.

Since ValueandValueProposition class on M1/1 Cognitive Level of DIH Model Representation metaclass is associated to DIH through elements which on M1/2 Cognitive Level of DIH Model Representation don't have metaclasses, it will be associated to VDML Element metaclass. That can be seen on Fig. 10. below. On this figure, it can also be seen how VDMLelement metaclass will be associated to Value Delivery Model metaclass, so it covers steps 2, 3 and 4.

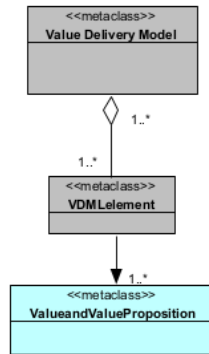

Fig. 10. ValueandValueProposition Metaclass in M1/2 Cognitive Level of DIH Model Representation.

- Client/customer which looks at DIH's web page and decides to visit DIH is either private **Person** (human **Actor**) or legal entity (**OrgUnit**), so those three metaclasses were associated to metamodel. Composition of Person class, here drawn as metaclass, is described in text above. On the Fig. 7. above, this logic would pertain to part of the figure depicted on Fig. 11. below, based on OMG's VDML specification [35]:

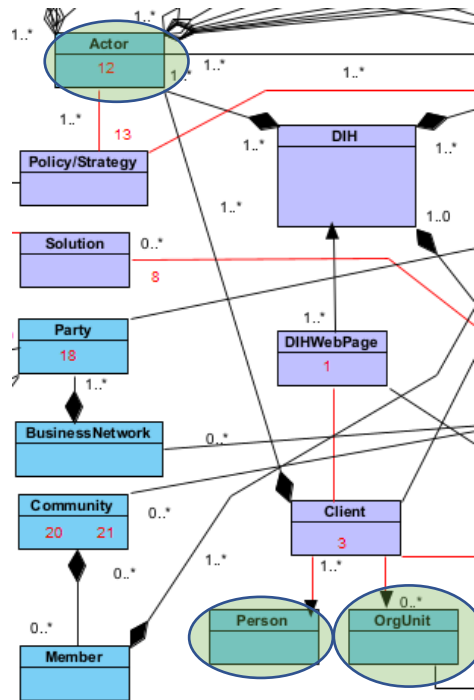

Fig. 11. M1/1 Cognitive Level of Person and OrgUnit Classes in DIH Model Representation.

Following the same logic, on M1/2 Cognitive Level of DIH Model Representation, metaclasses Person and OrgUnit will be connected to **Actor** metaclass as depicted on Fig. 12. Below, covering step 5.

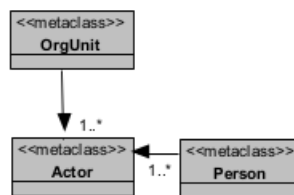

Fig. 12. OrgUnit and Person Metaclasses Associated to Actor Metaclass in M1/2 Cognitive Level of DIH Model Representation.

6. Actor metaclass–trough **Activity** metaclass associated to VDML element, which is according to OMG’s specification a shared abstract class and includes primary elements of the model [19, p. 55].; Client /customer (which is a Person or OrgUnit) interacts with DIH trough different activities, and that’s why metaclass Activity was

recognized in DIH and added to the metamodel. On the Fig. 7. above, this logic would pertain to this part of the figure depicted on Fig. 13. below, based on OMG's VDM specification [35]:

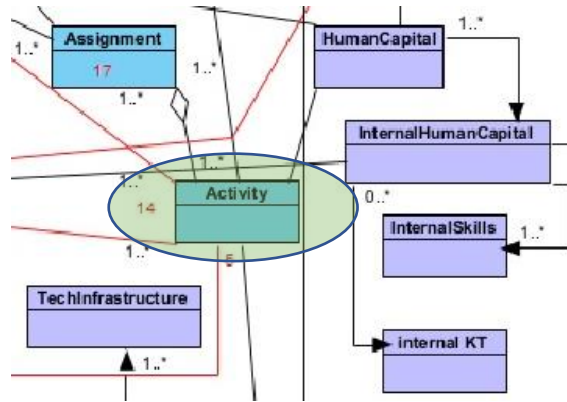

Fig. 13. M1/1 Cognitive Level of Activity Class in DIH Model Representation.

Following the same logic, on M1/2 Cognitive Level of DIH Model Representation, metaclasses Activity metaclass will be connected to Actor and VDM element metaclasses as depicted on Fig. 14. below, covering step 6.

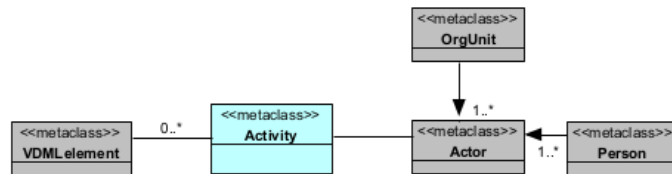

Fig. 14. Activity Metaclass Associated to Actor and VDM element Metaclasses in M1/2 Cognitive Level of DIH Model Representation.

7. Solution (**BusinessItem**) which the Client/customer seeks is achieved through various different collaborations, so BusinessItem was also recognized in DIH and added to metamodel. DIH's office collaborates with other entities when it cannot find solution alone; hence the **Collaboration** metaclass. On the Fig. 7. above, this logic would pertain to this part of the figure depicted on Fig. 15. below, based on OMG's VDM specification [35]:



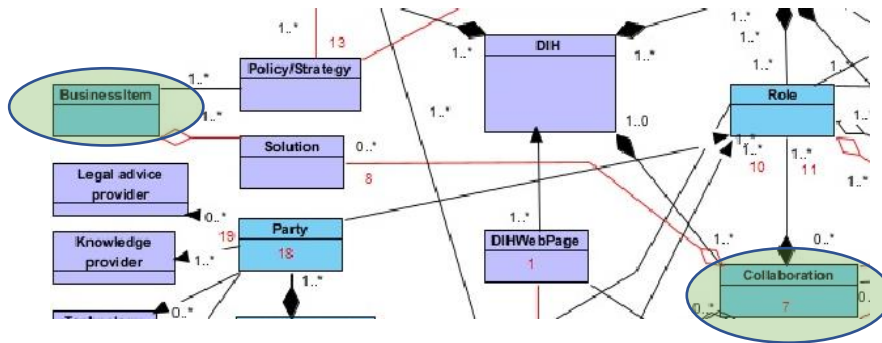

Fig. 15. M1/1 Cognitive Level of BusinessItem and Collaboration Classes in DIH Model Representation.

Following the same logic, on M1/2 Cognitive Level of DIH Model Representation, metaclasses BusinessItem and Collaboration will be connected to Collaboration metaclass as depicted on Fig. 16. below, covering step 7.

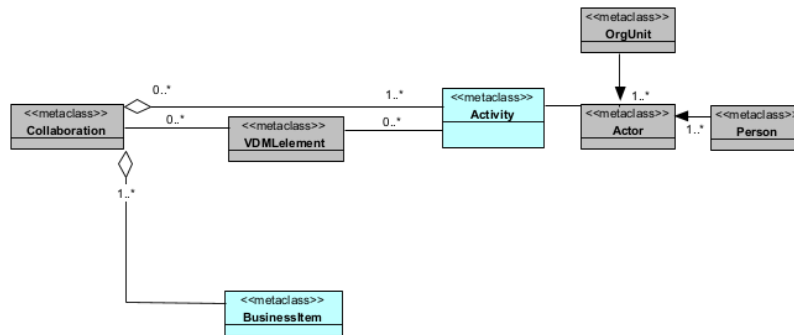

Fig. 16. BusinessItem and CollaborationMetaclasses Associated to Collaboration Metaclasses in M1/2 Cognitive Level of DIH Model Representation.

8. According to OMG’s VDM specification, multiple **Participant** (human/non-human Actor or another *Collaboration*) take part in collaboration; hence Participants metaclass and multiplicities added to metamodel. Composition of Participants class, now part of Participants metaclass, was explained in text above. Based on OMG’s specification, Participants take part in collaboration, through their own one or more assigned Roles [19, p. 17]. **Role** metaclass with appropriate multiplicities was also added to metamodel. A Client/customer (Person and Actor with a Role of Customer),

is also a Participant directly involved in Collaboration. Based on OMG's specification, every participant can be a part of more than one collaboration [19, p. 14]. The aim of collaboration is finding the right solution (BusinessItem), so on the metamodel, Collaboration metaclass is associated to BusinessItem metaclass (just like Activity metaclass). Also, according to OMG's specification, Collaboration is composed of one or more **Activities**, each performed by one Role in Collaboration [36, p. 14]. On the Fig. 7. above, this logic would pertain to this part of the figure depicted on Fig. 17. below, based on OMG's VDM specification [35]:

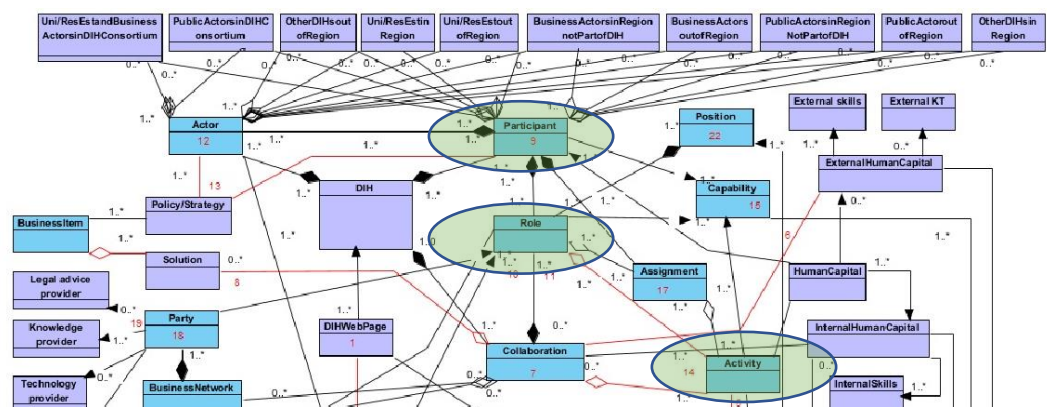

Fig. 17. M1/1 Cognitive Level of Participant Class in DIH Model Representation.

Following the same logic, on M1/2 Cognitive Level of DIH Model Representation, metaclasses Participant, Role and Activity will be connected as depicted on Fig. 18. below, covering step 8.

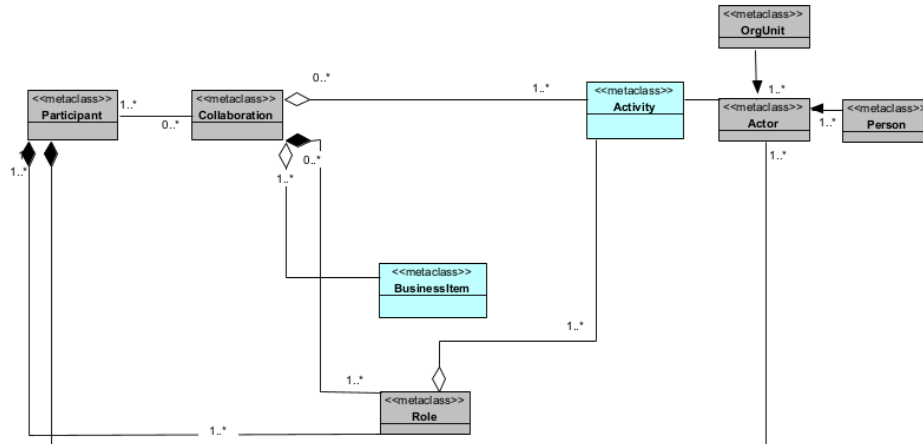

Fig. 18. Participant, Role and Activity Metaclasses in M1/2 Cognitive Level of DIH Model Representation.

9. Metaclasses **RoleLibrary**, **RoleDefinition** and **RoleCategory** were connected to metamodel, since they are required elements of VDML metamodelling conformance specification [19, pp. 3-4], and they are in the metamodel connected to the Role metaclass. These were not represented on M1/1 Cognitive Level of DIH Model representation, and can be seen on Fig. 19. below, covering step 9.

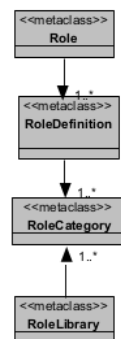

Fig. 19. Role, RoleDeifnition, RoleCategory and RoleLibrary Metaclasses in M1/2 Cognitive Level of DIH Model Representation.

10. According to OMG’s specification, one Role may perform more than one Activity and if they require different Capabilities, Participant should be able to cover them all [19, p. 18]; therefore, **Capability** and **CapabilityLibrary** metaclasses found in DIH were

added to DIH metamodel in VDML, where all the capabilities that DIH has to offer are in CapabilityLibrary class. On the Fig. 7. above, this logic would pertain to this part of the figure depicted on Fig. 20. below, based on OMG's VDML specification [35]:

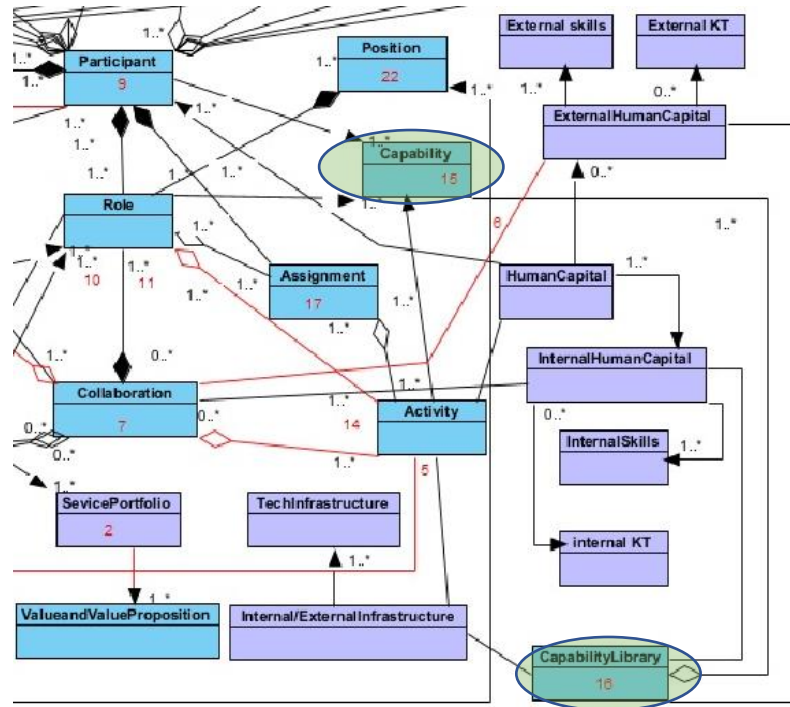

Fig. 20. M1/1 Cognitive Level of Capability and CapabilityLibrary Classes in DIH Model Representation.

Following the same logic, on M1/2 Cognitive Level of DIH Model Representation, metaclasses Capability and CapabilityLibrary will be connected as depicted on Fig. 21., covering step 10.

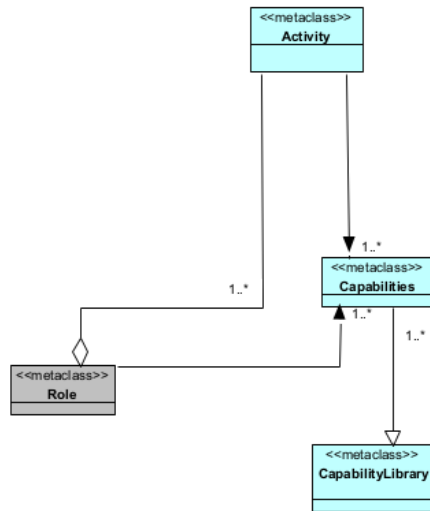

Fig. 21 Capability and CapabilityLibrary Metaclasses in M1/2 Cognitive Level of DIH Model Representation.

11. According to OMG's specification, Participant is involved in Activity through *Assignment*, which specifies how a Role in a Collaboration can be fulfilled [19, p. 34], and that is how Assignment metaclass is associated to metamodel. On the Fig. 7. above, this logic would pertain to this part of the figure depicted on Fig. 22. below, based on OMG's VDML specification [35]:

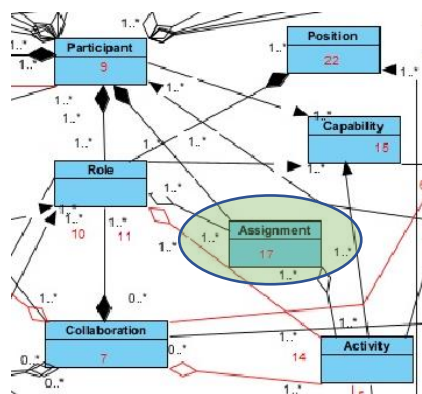

Fig. 22. M1/1 Cognitive Level of Assignment Class in DIH Model Representation.

Following the same logic, on M1/2 Cognitive Level of DIH Model Representation, Assignment metaclass will be connected as depicted on Fig. 23, covering step 11.

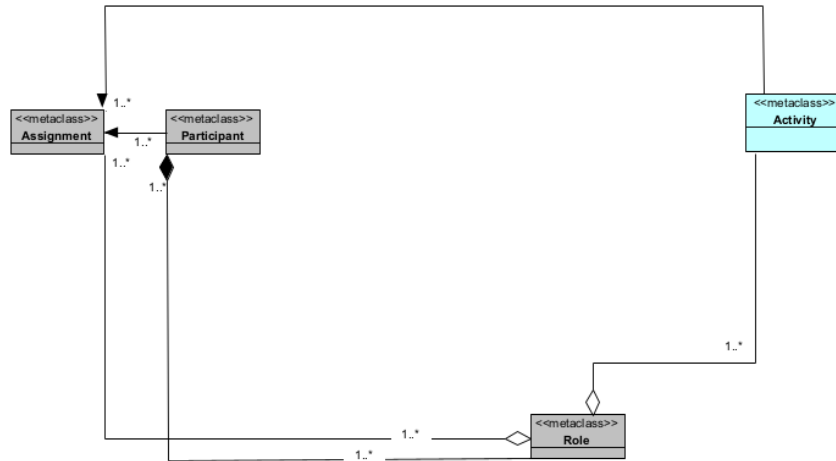

Fig. 23. Assignment Metallasses in M1/2 Cognitive Level of DIH Model Representation.

12. According to OMG’s specification, **BusinessNetwork** is Collaboration of **Parties**, which identify roles in business networks [19, p. 14], so BusinessNetwork and Party metaclasses were also connected in metamodel accordingly. The composition of BusinessNetworks class, now a part of BusinessNetwork metaclass was explained in text above. On the Fig. 7. above, this logic would pertain to this part of the figure depicted on Fig. 24. below, based on OMG’s VDMML specification [35]:

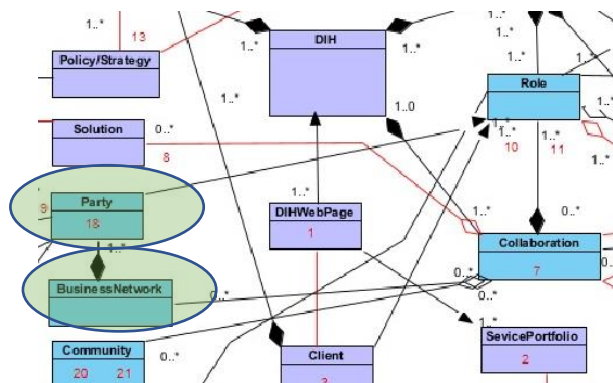

Fig. 24. M1/1 Cognitive Level of BusinessNetwork and Party Classes in DIH Model Representation.

Following the same logic, on M1/2 Cognitive Level of DIH Model Representation, BusinessNetwork and Party metaclasses will be connected as depicted on Fig. 25., covering step 12.

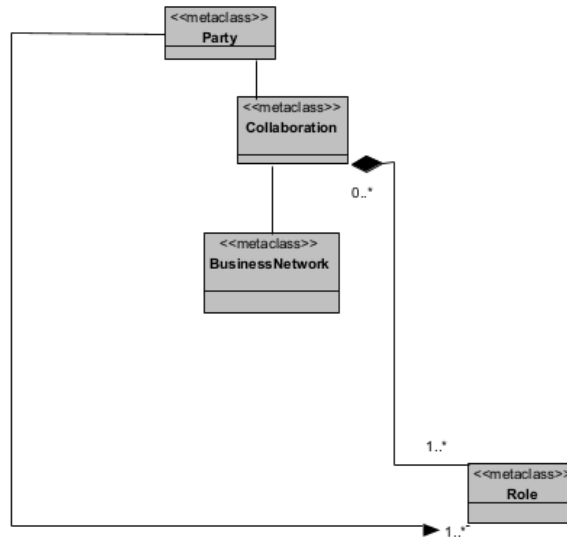

Fig. 25. BusinessNetwork and Party Metaclasses in M1/2 Cognitive Level of DIH Model Representation.

13. According to OMG's specification, Community is a collaboration of Participants, where a role is identified by *Member* [19, p. 45], so **Community** and Member metaclasses were also connected accordingly to the metamodel. On the Fig. 7. above, this logic would pertain to this part of the figure depicted on Fig. 26. below, based on OMG's VDML specification [35].

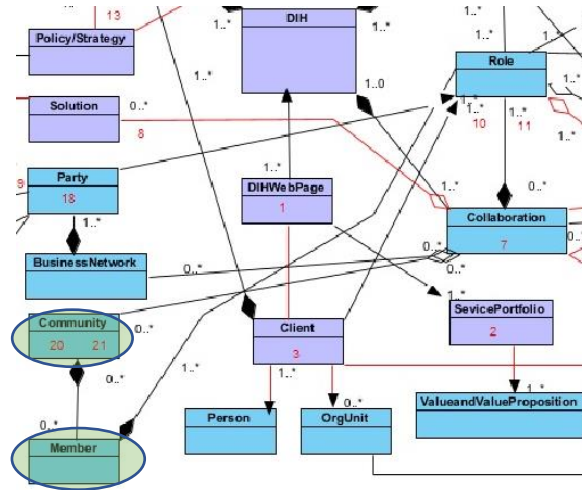

Fig. 26. M 1/1 Cognitive Level of Community and Member Classes in DIH Model Representation.

Following the same logic, on M1/2 Cognitive Level of DIH Model Representation, Member and Community metaclasses will be connected as depicted on Fig. 27., covering step 13.

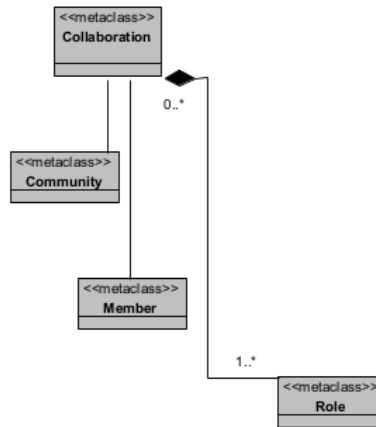

Fig. 27. Community and Member Metalasses in M1/2 Cognitive Level of DIH Model Representation.

14. According to OMG’s specification, Role in OrgUnit is identified by **Position** [19, p. 46], and therefore **Position** metaclass was connected accordingly to the metamodel. Multiplicities were added according to author’s own conclusion. On the Fig. 7. above,



this logic would pertain to this part of the figure depicted on Fig. 28. below, based on OMG's VDML specification [35]:

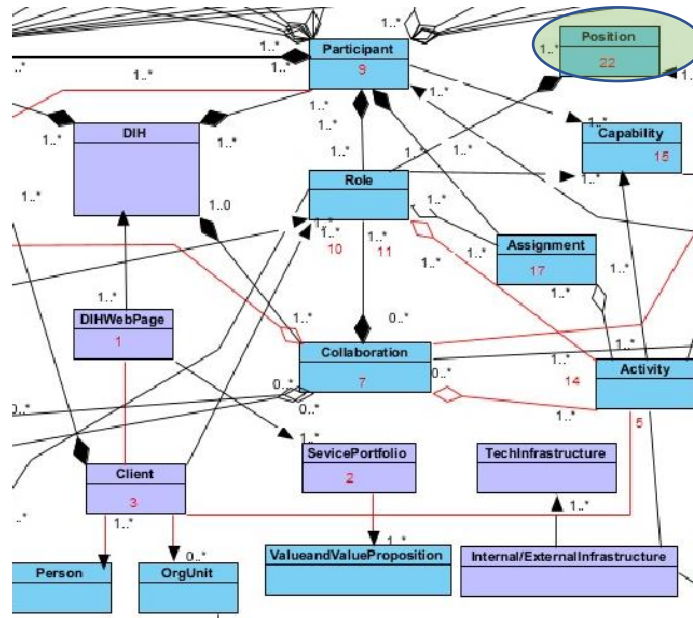

Fig. 28. M 1/1 Cognitive Level of Position Class in DIH Model Representation.

Following the same logic, on M1/2 Cognitive Level of DIH Model Representation, Position metaclass will be connected as depicted on Fig. 29., covering step 14.

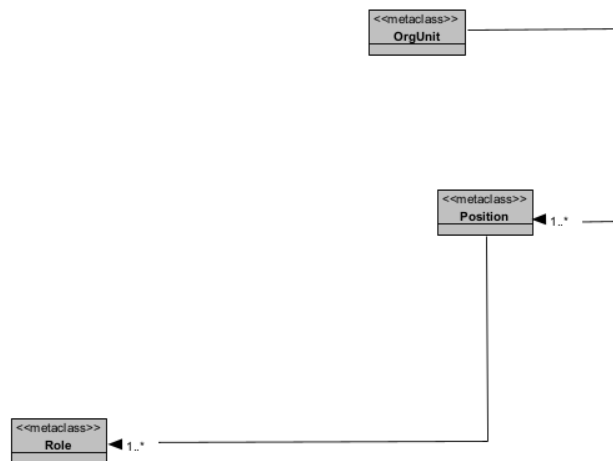

Fig. 29. Position Metaclass in M1/2 Cognitive Level of DIH Model Representation.

15. **MeasurableElement**, **MeasuredCharacteristic**, **Annotation** and **Attributes** were represented in accordance with OMG's specification [19, p. 56]. They were included in the representation because they are also concepts which are part of metamodeling conformance. These were not represented on M1/1 Cognitive Level of DIH Model representation. On M1/2 Cognitive Level of DIH Model Representation, these metaclasses will be connected as depicted on Fig. 30., covering step 15.

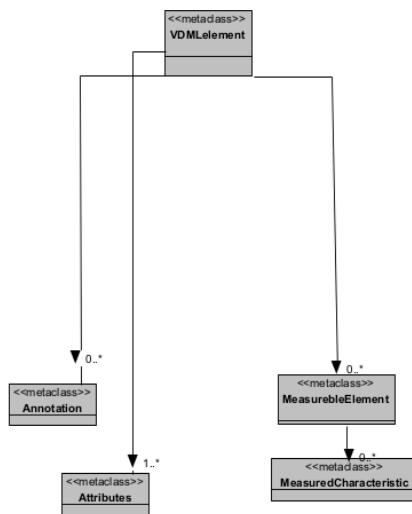

Fig. 30. MeasurableElement, MeasuredCharacteristic, Annotation and Attributes Metaclasses in M1/2 Cognitive Level of DIH Model Representation.

Based on this storyline, depiction of M1/2 Cognitive Level of DIH Model representation can be seen on Fig. 31. below. Prescribed 22 VDML metaclasses needed for metamodeling conformance based on OMG's specification [19, pp. 3-4] were depicted in gray color, and additional ones deemed necessary based on the storyline were added in blue color.



## 5.2. DIH Alignment with Other Referent Architectures

In the sections below, other referent architectures will be described. Those other referent architectures provide different views of DIH, focusing on its different aspects. They are Osterwalder business model canvas, TOGAF, REA, e<sup>3</sup>value and Lindgren's Business Model Cube. Some of them were already mentioned, their models and metamodels will be provided, and will be elaborated upon in much more detail. DIH elements in support of them will be determined.

### 5.2.1. Osterwalder's Business Model Canvas

One of the many functionalities of VDMbee platform are VDMbee Business Model Canvases, and the canvases that VDMbee supports are BMC, Business Model Innovation Canvas, Lean Startup Canvas, Lean Change Canvas, SWOT Analysis Canvas, Personal BMC and Integrated Reporting Canvas (M. Adams) [313]. The same source further states that BMCs which VDMbee covers are the BMC by Alexander Osterwalder, The Business Model Innovation Canvas by Peter Lindgren, Lean Startup Canvas, Lean Change Canvas, SWOT Analysis Canvas (SWOT Matrix), Personal BMC and Integrated Reporting Canvas by M. Adams. BMC makes a record of ideas regarding new or transformed business model, that can be mapped and used for modeling and prototyping strategy and analyzing innovation or transformation impact [314]. The same source further states that BMC of Alexander Osterwalder consists of nine elements: key partners, key activities, key resources, value propositions, customer relationship, channels, customer segments, cost structure and revenue streams, and for which VDMbee created a simulation.

In the text below, DIH elements Supporting Value Creation and Osterwalder's BMC, Osterwalder's BMC Model and Metamodel will be explained.

### 5.2.2. DIH Elements Supporting Value Creation and Osterwalder's BMC

To be able to answer the question which DIH elements support value creation, DIH concepts conceptually mapped onto VDML classes already explained are mapped onto elements of Osterwalder's BMC. This is conducted with the purpose of establishing whether mapping between VDML and other methods is possible. Each Alex's BMC element was shown in the second column of the Table 31. in Appendix 3., and each DIH source of literature has a column for showing the examples of those concepts, and also a column for comments with VDML classes. Mapping is conducted in accordance with OMG's VDML specification [19, p. 111].

VDML concepts mapping onto BMC concepts is possible, and the mapping logic is the following: Channel maps onto Channel; Value Contribution Component (Cost) maps onto Cost Structure; Collaboration maps onto Customer Relationships; Community maps onto Customer Segment; Capability Library maps onto Key Activities; Business Network maps onto Key Partnerships; Capability maps onto Key Resources; Business Network maps onto Revenue Stream; and Value proposition maps onto Value proposition [19, p. 111].

BMC element 'Customer Segment' partially maps onto VDML element 'Community'; 'Value Propositions' onto 'Value and Value Proposition'; 'Channels' and 'Customer Relationships' do not map onto any particular VDML element but it is possible to inherently find those concepts in DIH literature; 'Revenue Streams' do not map onto anything because DIHs are non-profit; and 'Key resources' can be mapped onto 'Resources and Stores'.

So, VDML concepts mapping onto BMC concepts is possible; it is possible to directly map 10 VDML concepts onto BMC concepts and 2 BMC elements can partially map onto VDML. Two BMC concepts do not map onto any particular VDML element but it is possible to inherently find those concepts in DIH literature and only one BMC concept does not map onto anything.

### 5.2.3. Osterwalder's BMC Model and Metamodel

The storyline of Osterwalder's BMC, enriched with some additional exemplary members which can be related to DIH, would be the following:

1. As already mentioned above, Osterwalder's BMC consists of **nine elements**: key partners, key activities, key resources, value propositions, customer relationship, channels, customer segments, cost structure and revenue streams [314]. These nine elements will be drawn as classes in BMC model. Those elements are on Fig. 20. below displayed in gray color.
2. Those nine elements cover feasibility, desirability and viability, which are the **three main business areas** [315]. These three business areas will on BMC model be drawn in dark gray color, and will be associated with one another.
3. **Desirability area**, focusing on what the customers want, covers one or more of the following elements: value propositions, customer relationship, channels, and customer segments [315], so they will be directly associated to Desirability class, all multiplicities being one-to-many.
4. **Feasibility area**, focusing on the ability to deliver, covers one or more of the following key elements: partners, activities, and resources [315] those three elements will be directly associated to Feasibility class, all multiplicities being one-to-many.
5. **Viability area**, focusing on whether something is worth the endeavor, covers one or more elements of cost structure and also streams of revenue [315] so those two elements will be directly associated to Viability class, all multiplicities being one-to-many.
6. **Value Proposition element** "describes the bundle of products and services that create value for a specific Customer Segment" [315], so the value proposition class will be associated with customer segment element with one-to-many multiplicity.
7. Value Proposition class (in blue color) will be directly associated to **Classes products and services** because those would be examples of one or more elements belonging to that class, and which pertain to DIH, all multiplicities being one-to-many.
8. **Customer segments element** "defines the different groups of people or organizations an enterprise aims to reach and serve" [315], **Companies class** (drawn in blue color) is directly associated with it.

9. **Channels element** “describes how a company communicates with and reaches its Customer Segments” [315], so channels class will be associated to customer segments class with one-to-many multiplicities on both sides of association.
10. **Customer relationships element** “describes the types of relationships a company establishes with specific Customer Segments” [315], customer relationships class will be associated to customer segments class with zero-to-many multiplicities on both sides.
11. **Revenue streams element** “represents the cash a company generates from each Customer Segment” [315], so revenue streams class will be associated with customer segments class with zero-to-many associations.
12. **Cost structure element** “describes all costs incurred to operate a business model” [315], **costs class** will be drawn (in blue color) and directly associated to CostStructure class, because that would be an example of one or more element belonging to that class, multiplicity being one-to-many.
13. **Key resources element** “describes the most important assets required to make a business model work; every business model requires Key Resources” [315], one or more **HumanCapital** and **Infrastructure classes** will be directly associated to KeyResources class, multiplicity being one-to-many, because those would be examples of elements belonging to that class, which also pertain to DIH.
14. **Key resources element** “allow an enterprise to create and offer a Value Proposition, reach markets, maintain relationships with Customer Segments, and earn revenues” [315], key resources class will be associated to value proposition class with zero-to-many multiplicities on both sides (drawn in in blue color),
15. **Key activities element** “are the most important actions a company must take” [315], so **Activity** class will be drawn (drawn in blue color), will be directly associated to KeyActivities class, associated with one-to-many multiplicity, because that would be an example of element belonging to that class, which also pertain to DIH.
16. **Key partners element** “describes the network of suppliers and partners that make the business model work” [315], so **OtherDIHs** and **Universities classes** (drawn in blue color) will be directly associated to KeyPartners class with zero-to-many

multiplicities, because that would be an example of element belonging to that class, which also pertain to DIH.

Based on this Osterwalder's BMC storyline, enriched with some additional exemplary members of the given classes, model was created and can be seen on Fig. 32. below. ValueProposition class is highlighted, as one of the main DIH (meta)model elements, which contains purpose of a DIH, and it should be emphasized that it is an element of this referent architecture as well.

Legend for the Fig. 32. below is therefore the following:

1. gray color - Osterwalder's BMC nine main elements,
2. dark gray color - Osterwalder's BMC three main business areas,
3. blue color – additional elements belonging to different classes which pertain to DIH and/or are examples of classes belonging to some parent class.



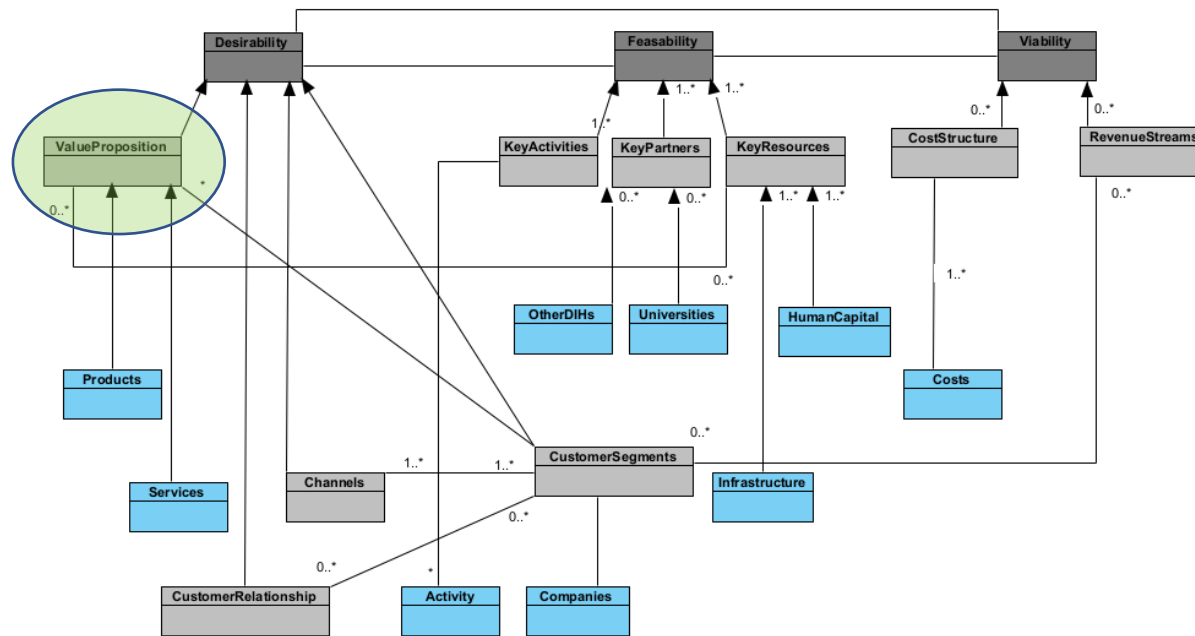

Fig. 32. Osterwalder's BMC Model Enriched with Some Additional Exemplary Members of the Given Classes.

Also, as an example, BMC proposed metamodel created by two researchers is displayed on Fig. 33. below. It can be seen that it consists of nine fundamental Osterwalder's BMC elements: key partners, key activities, key resources, value propositions, customer relationship, channels, customer segments, cost structure and revenue streams [288], drawn as metaclasses. This metamodel could be considered a higher level of abstraction in relation to BMC model on Fig. 32.

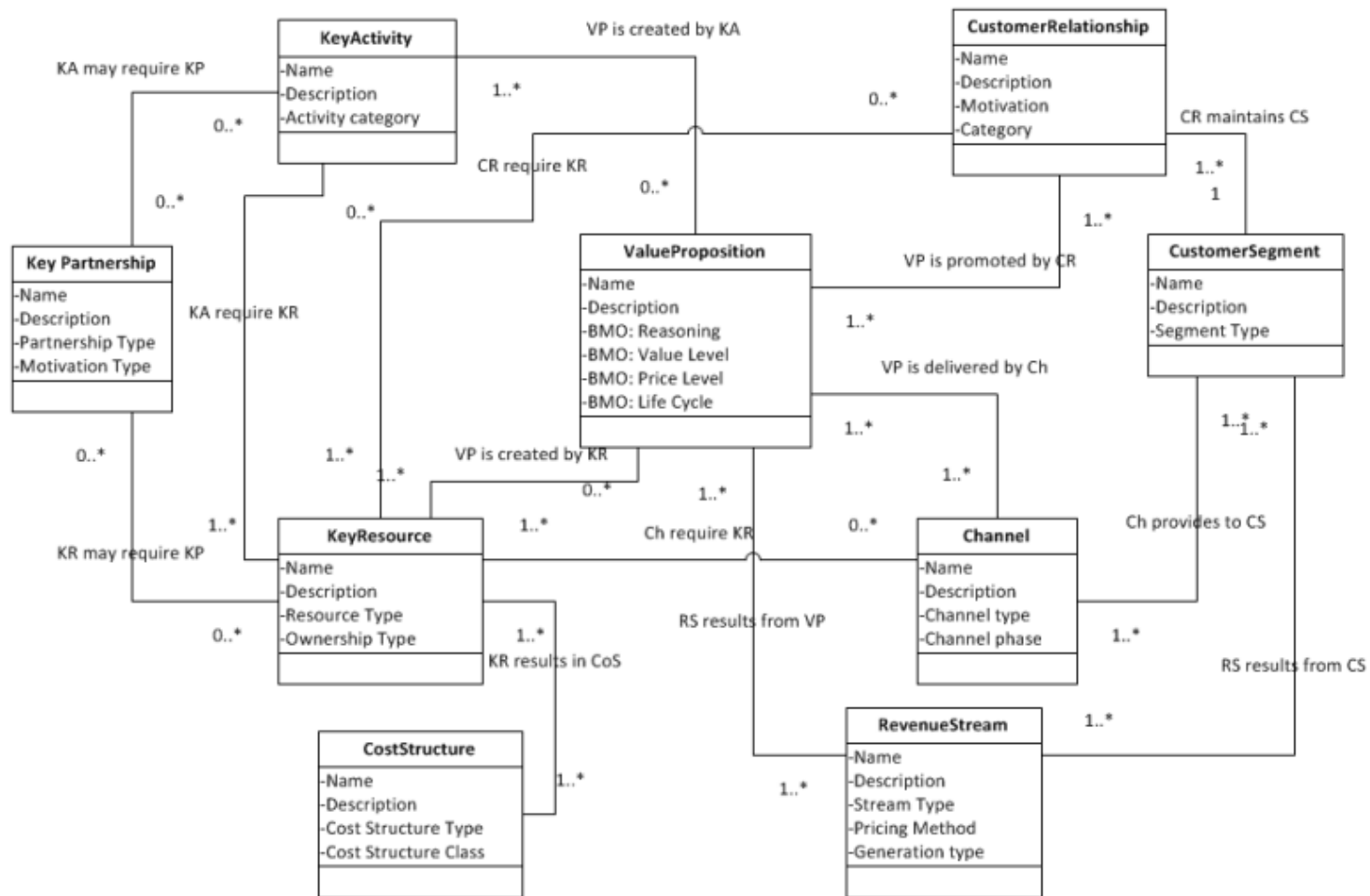

Fig. 33. BMC Metamodel Proposal. Source: [316, p. 3].

This BMC metamodel proposal storyline from the Fig. 33. above would be the following:

1. One-to-many CostStructure classes are associated with one-to-many KeyResource classes (KeyResource results in CostStructure). Zero-to-many KeyResource classes are associated to zero-to-many KeyPartnership classes (KeyResource may require KeyPartnership).
2. One-to-many KeyResource classes are associated to: zero-to-many KeyActivity classes (KeyActivity requires KeyResource), zero-to-many CustomerRelationship classes (CustomerRelationship requires KeyResource), zero-to-many ValueProposition classes (ValueProposition is created by KeyResource), and zero-to-many Channel classes (Chanel requires KeyResource).
3. Zero-to-many KeyPartnership classes are associated to zero-to-many KeyActivity classes (KeyActivity may require KeyPartnership). One-to-many KeyActivity classes are connected to zero-to-many ValueProposition classes (ValueProposition is created by KeyActivity).
4. On-to-many ValueProposition classes are connected to: one-to-many CustomerRelationship classes (ValueProposition is promoted by CustomerRelationship), one-to-many Channel classes (ValueProposition is delivered by Channel), and one-to-many RevenueStream classes (RevenueStream results from ValueProposition).
5. One-to-many CustomerRelationship classes are associated to one CustomerSegment class (CustomerRelationship maintains CustomerSegment).
6. One-to-many CustomerSegment classes are associated with one-to-many Channel classes (Channel provides to CustomerSegment) and to one-to-many RevenueStream classes (RevenueStream results from CustomerSegment).

It is possible to create Osterwalder's BMC model enriched with some additional exemplary elements which can be related to DIH, and a metamodel.

### 5.2.4. Value Network Analysis

Value Network Analysis (VNA) defines different Roles in Collaboration and also value creation through Deliverables exchange, with the aim of: leveraging (non)financial resources; discovering value opportunities; increasing value outputs and their optimization; improving organizational, operational performance, financial performance; and improvement of flows of value, where Roles and Value Transactions are depicted in the form of a graphs or maps [19, p. 101]. An example of VNA is shown on Fig. 34. below.

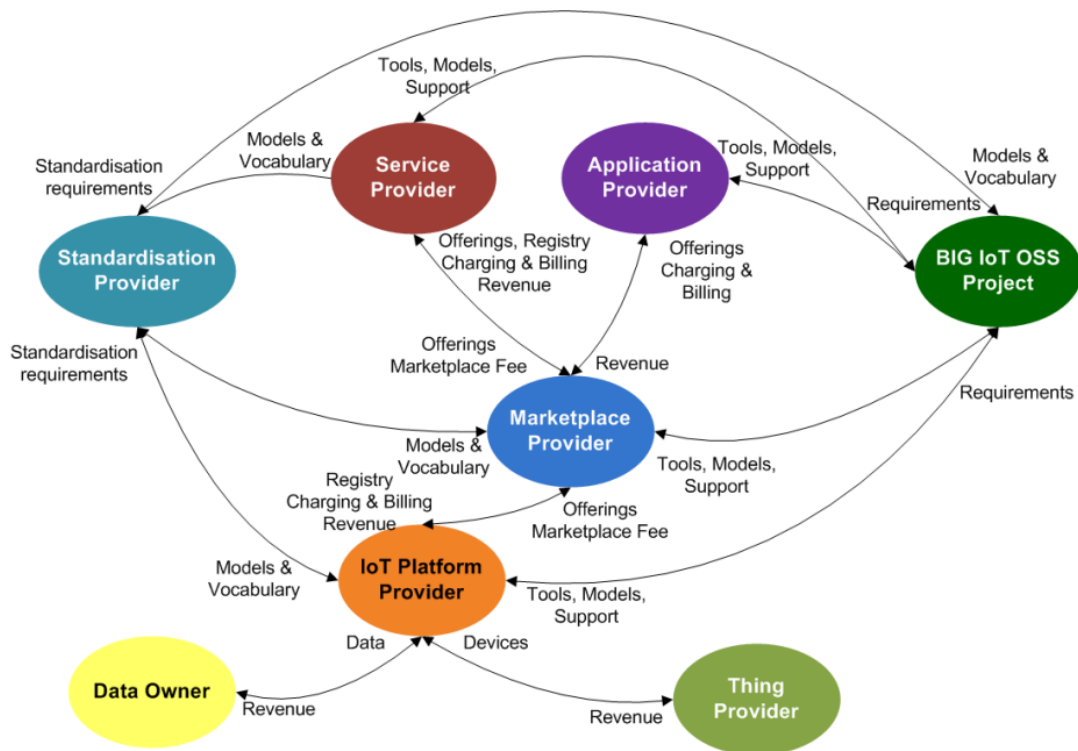

Fig. 34. Value Network Model for Interoperable IoT Ecosystems. Source: [317, p. 7].

The following section 5.3.1. below discuss VDML DIH concepts mapped onto VNA and VNA Model.

### 5.2.5. VDML DIH Concepts Mapped onto VNA

VDML DIH concepts mapping onto VNA is also performed in order to establish whether mapping between VDML and other methods is possible; in this case into VNA. The results are in Table 32. in Appendix 3. Mapping is conducted in accordance with OMG's VDML specification [19, pp. 102-103]. Based on the elements of Role and Value in the table, an example of DIH VNA Graph was created on the Fig. 35. below.

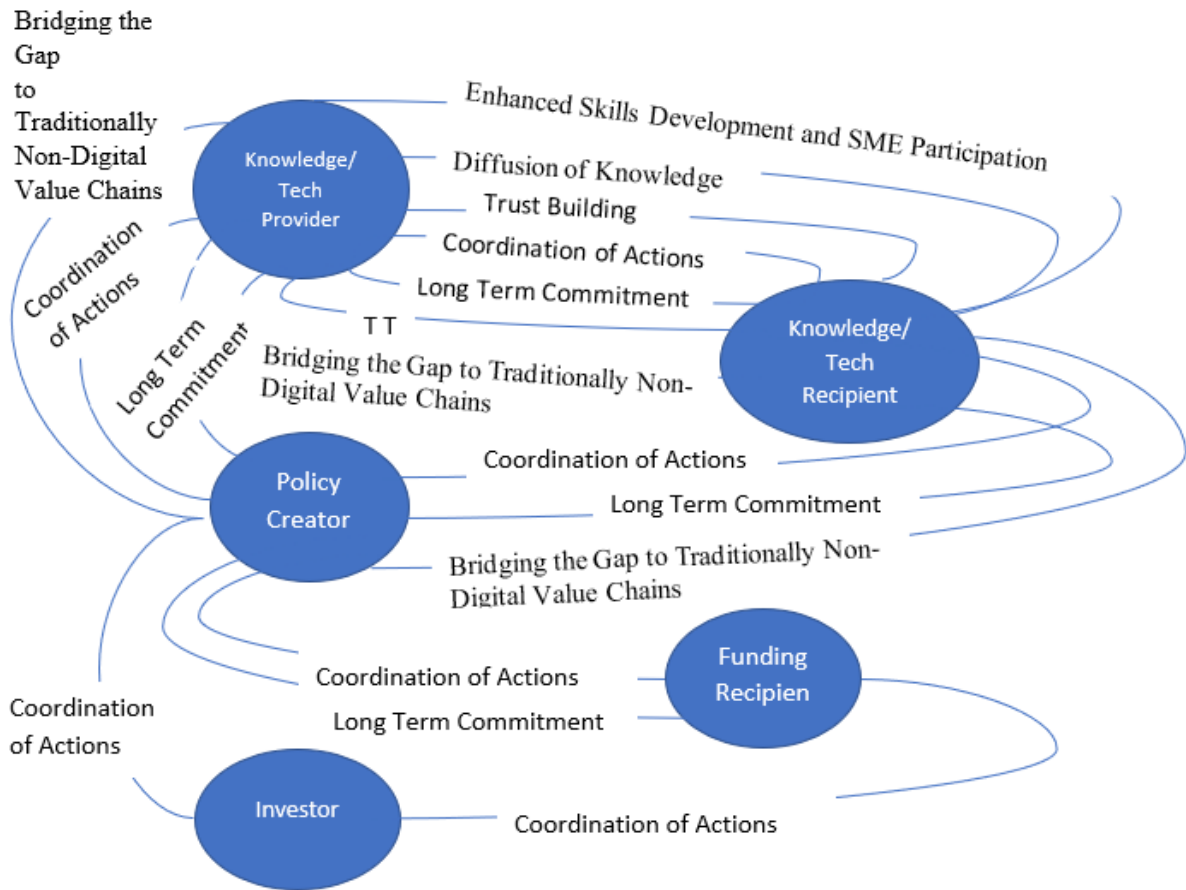

Fig. 35. DIH VNA Graph Example.

Mapping VDML DIH concepts onto VNA is possible.

### 5.2.6. VNA Model

The storyline of VNA would be the following:

1. VNA “sets the relationship between business activities and the value network by evaluating members of an organization” [318]. **Value Network class** will be depicted as composition of one-to-many **BusinessActivities classes**.
2. VNA is used “to optimize both the internal and external business operations [318], so **InternalBusinessOperations** and **ExternalBusinessOperations classes** will be directly associated to Business activities class, with one-to-many multiplicities.
3. Based on 1. and 2. (and [318]), internal business operations and external business operations classes will be associated to **Member class** with one-to-many multiplicity, because every one of those activities can be conducted with one of more member/participant of business activity, and same members can participate in both kinds of operations.
4. Since VNA determines “value creation properties of members and their value interactions” [318], **ValueCreationProperties class** and **ValueInteractions class** will be associated to member class with one-to-many multiplicities on Member class side zero-to-many and on other sides of association.
5. Networks, and therefore also a value network, are comprised of “specific roles and value relationships inclined towards achieving a specific outcome” [318], so **Role**, **ValueRelationship** and **Outcome classes** will be associated to value network class. Outcome class will be associated with direct association, zero-to-many multiplicity, role class will be associated with direct association, one-to-many multiplicity, and value relationship class will be associated with zero-to-many multiplicity on value relationship side and one-to-many on value network class.
6. Since regarding members this statement is given: “The active members within networks are real people who play significant roles in the exchange of benefits such as knowledge and ideas necessary for business operations.” [318], **People class** will be directly associated to member class and will be connected to role class with one-to-many multiplicities.

7. Based on 6. (and [318]), **ExchangeofBenefits** class will be directly associated to business activities class with zero-to-many multiplicity, and was associated to member, external business operations and internal business operations classes with one-to-many multiplicities and zero-to-many multiplicities on the side of exchange of benefits side.
8. Based on 6. (and [318]), **knowledge and ideas** classes were drawn as child classes of will be directly associated to ExchangeofBenefits class.

Based on this VNA storyline, model was created and can be seen on Fig. 36. below, based on [318]. ValueNetwork class is highlighted, because it contains the value created for the customer, which is the essence of VDS; DIH as well.

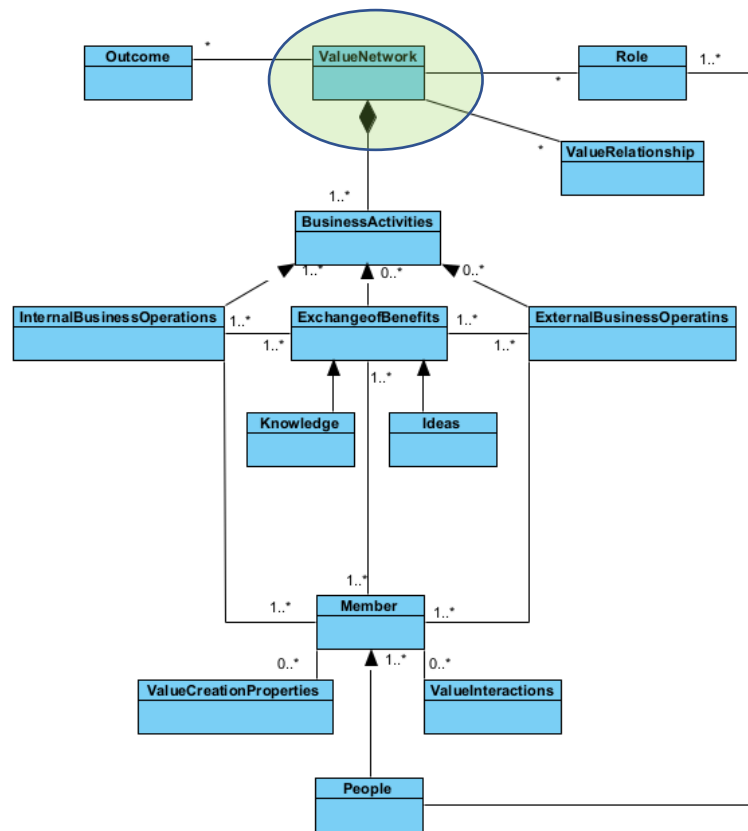

Fig. 36. VNA Model.

Therefore, it is possible to create a VNA model as well.

## 5.2.7. TOGAF

The Open Group's TOGAF® standard for Enterprise Architecture methodology and also framework for business efficiency improvement, includes content framework which ensures consistency regarding outputs created with ADM [17]. Speaking about ADM, it is worth mentioning that it automates REA design models for information systems, business and technology architecture [319, p. 10]. The latest TOGAF version (9.2), has a modular structure, and besides already mentioned content framework, also set of extended guidelines and concepts and various different architectural styles [17]. TOGAF Scope can be seen on Fig. 37. below.

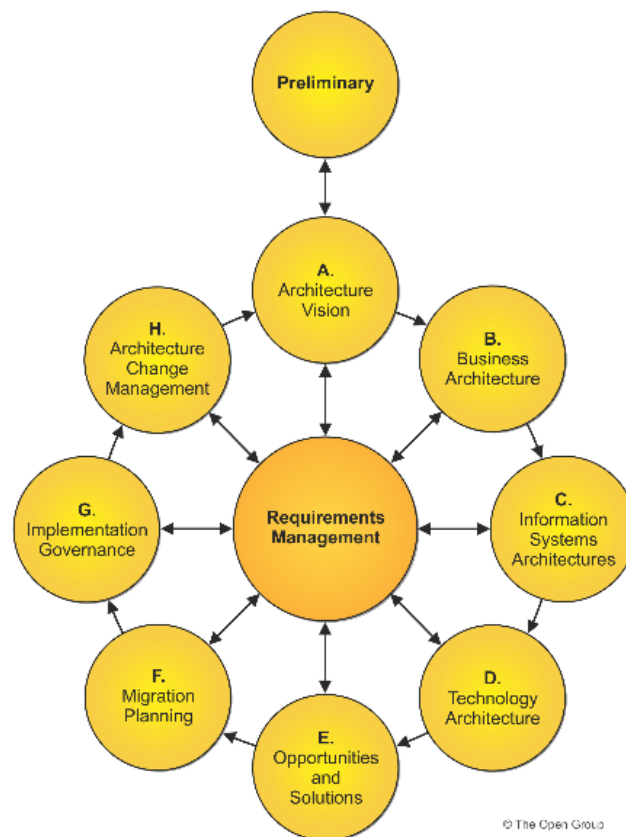

Fig. 37. TOGAF Scope. Source: The Open Group [17].

The Open Group Architecture Forum addresses different issues, amongst others also digital enterprises and how Enterprise Architecture (EA) can optimize existing capabilities and



identify new capabilities needed for organizations DT, and in that regard TOGAF should support DT trends encompassing also business transformation not pertaining to IT [320, p. 2]. The following section 5.4.1. discusses TOGAF Metamodel and TOGAF and DIH Value Streams.

#### 5.2.8. TOGAF Metamodel

Fig. 38. below shows TOGAF Core Content Metamodel [320]. From it, it can be seen that Value Stream element is influenced by Course of Action element, and it enables business capability element. Value Stream element is operationalized by process element and is triggered by/involves actor element.

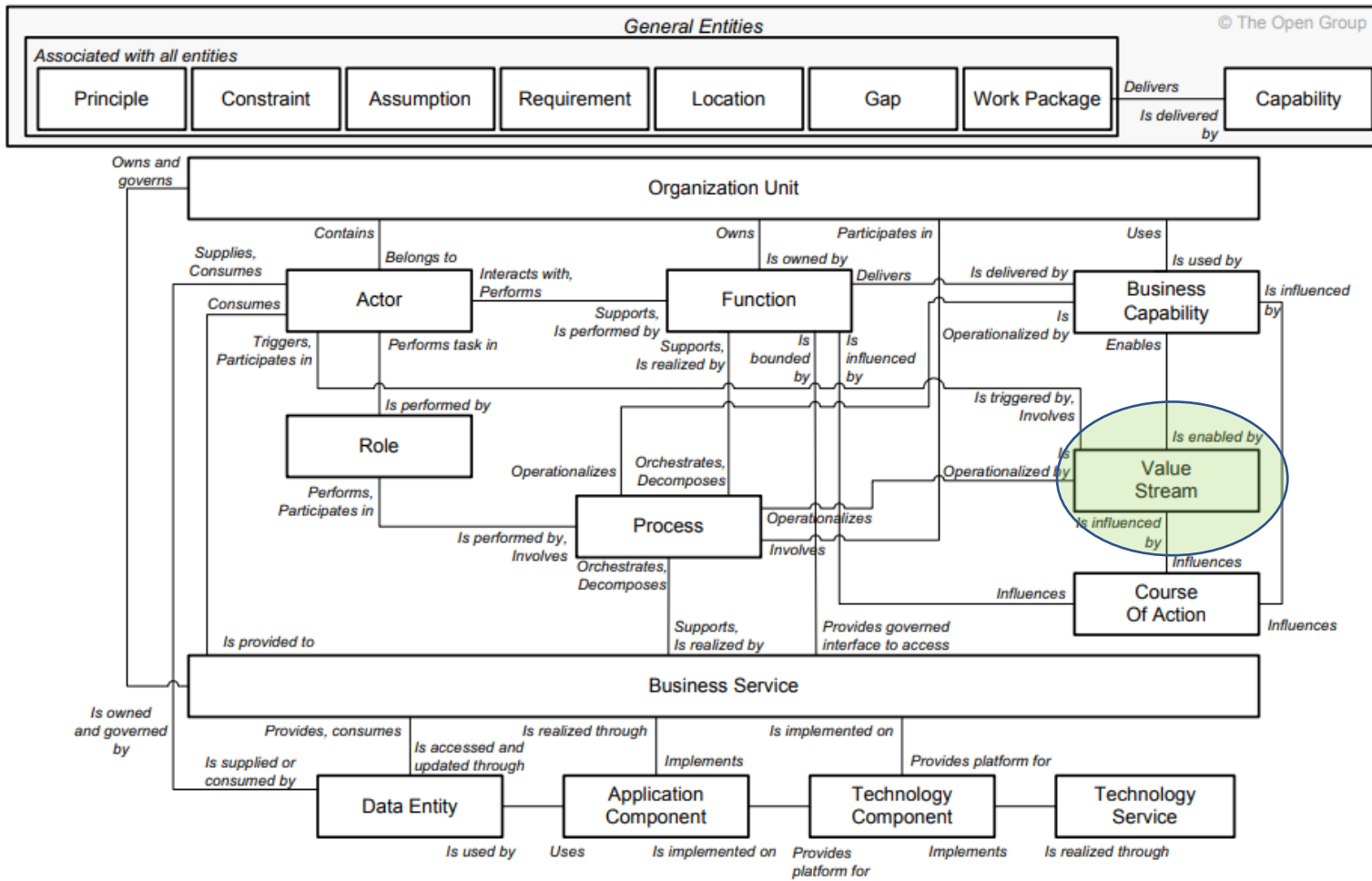

Fig. 38. TOGAF Core Content Metamodel. Source: The Open Group [320, p. 9].

TOGAF Core Content Metamodel storyline would be the following:

1. BusinessService class is associated to: OrganizationUnit class (BusinessService class is owned and governed by OrganizationUnit class; OrganizationUnit class owns and governs BusinessService class), Actor class (BusinessService class is provided to Actor class; Actor class consumes BusinessService class), DataEntry class (DataEntry class is accessed and undated trough BusinessService class; BusinessService class provides/consumes DataEntry class), ApplicationComponent class (BusinessService class is realized through ApplicationComponent class; ApplicationComponent class implements BusinessService class), TechnologyComponent class (BusinessService class is implemented on TechnologyComponent class; TechnologyComponent class provides platform for BusinessService class), Process class (BusinessService class supports/is realized by Process class; Process class orchestrates/decomposes BusinessService class), and Function class (BusinessService class provides governed interface to access Function class; Function class is bounded by BusinessService class).
2. DataEntry class is associated to Actor class (DataEntry class is supplied or consumed by Actor class; Actor class consumes DataEntry class) and to ApplicationComponent class (DataEntry class is used by ApplicationComponent class; ApplicationComponent class uses DataEntry class). ApplicationComponent class is associated to TechnologyComponent class (ApplicationComponent class is implemented on TechnologyComponent class; TechnologyComponent class provides platform for ApplicationComponent class). TechnologyComponent class is associated to TechnologyService class (TechnologyComponent class implements TechnologyService class; TechnologyService class is realized through TechnologyService class).
3. Process class is associated to: Role class (Process class is performed by/involves Role class; Role class performs/participates in Process class), BusinessCapability class (Process class orchestrates/decomposes BusinessCapability class; BusinessCapability class is operationalized by Process class), Function class (Process class orchestrates/decomposes Function class; Function class supports/is realized by Process

- class), ValueStream class (Process class operationalizes ValueStream class; ValueStream class is operationalized by Process class), and OrganizationalUnit class (Process class involves OrganizationalUnit class; OrganizationalUnit class participates in Process class).
4. CourseofAction class is associated to: Function class (CourseofAction class influences Function class; Function class is influenced by CourseofAction class), ValueStream class (CourseofAction class influences ValueStream class; ValueStream class is influenced by CourseofAction class), and BusinessCapability class (CourseofAction class influences BusinessCapability class; BusinessCapability class is influenced by CourseofAction class).
  5. ValueStream class is associated to BusinessCapability class (ValueStream class is enabled by BusinessCapability class; BusinessCapability class enables ValueStream class), and to Actor class (ValueStream class is triggered by/involves Actor class; Actor class triggers/participates in ValueStream class).
  6. BusinessCapability class is associated to Function class (BusinessCapability class is delivered by Function class; Function class delivers BusinessCapability class) and to OrganizationUnit class (BusinessCapability class is used by OrganizationUnit class; OrganizationUnit class uses BusinessCapability class).
  7. Function class is associated to BusinessCapability class (Function class is owned by BusinessCapability class; BusinessCapability class owns Function class), and to Actor class (Function class supports/is performed by Actor class; Actor class interacts with/performs Function class).
  8. Actor class is associated with OrganizationUnit class (Actor class belongs to OrganizationUnit class; OrganizationUnit class contains Actor class) and to Role class (Actor class performs task in Role class; Role class is performed by Actor class).
  9. General entities are the ones associated with all entities (classes: Principle, Constraint, Assumption, Requirement, Location, Gap and WorkPackage), and which are associated to Capability class (the ones associated with all entities deliver to Capability class; Capability class delivers to the ones associated with all entities).

Fig. 39. below shows TOGAF Full Content Metamodel, which besides TOGAF Core Content Metamodel also includes TOGAF extensions: Motivation Extension, Infrastructure

Consideration Extension, Process Modeling Extension, Services Extension, Governance Extension and Data Modeling Extension [320]. The same source claims that there are many artifacts Associated with the TOGAF Content Metamodel, and value chain diagram is being mentioned in a Preliminary development phase in Architecture Vision, whilst Value Stream Stages Catalog, Value Stream/Capability Matrix and Value Stream Map in Business Architecture development phase [320].



This subchapter gave informational overview of TOGAF Core Content Metamodel and TOGAF Full Content Metamodel, and shows the position of Value Streams in them.

### 5.2.9. TOGAF and DIH Value Streams

Techniques for analyzing value are value chains (economic approach), value networks (focused on participants) and lean value streams (focused on manufacturing processes); Business Architecture **value streams** focus on end-to-end stakeholders' view of value and in accordance with business model (Value Proposition) [264, pp. 1-3]. The same source further states that value definition is formed from the stakeholder's perspective; that it is "in the eye of the beholder" [264, p. 2]. Fig. 40. below depicts The Open Group's TOGAF relationships of a value stream, which consists of Value Stage and creates Value; Process operationalizes Value Stage and Capability which enables Value Stage; and Stakeholder participates in Value Stage, triggers Value Stream and receives Value [264, p. 3].

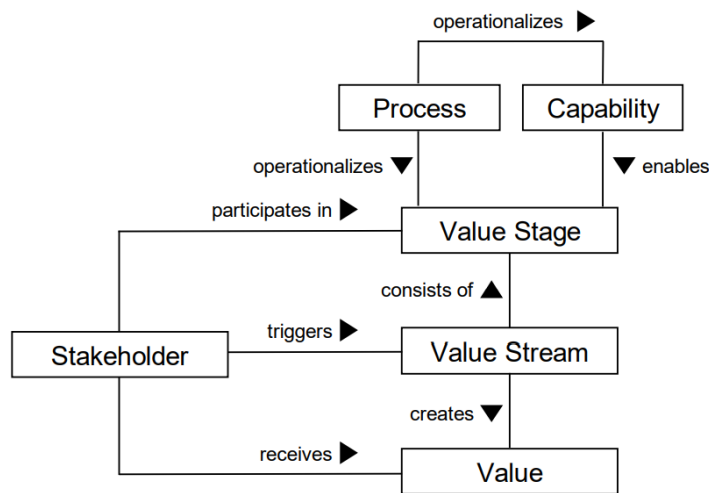

Fig. 40. TOGAF Value Stream Modeling Relationships. Source: The Open Group [264, p. 3].

Value is created/achieved through value stream stages, each containing the following elements: name, description, stakeholders, entrance criteria, exit criteria and value item, which can be mapped onto numerous business processes [264, pp. 3-6].

TOGAF does not impose any language, but proposes two options: a) UML, BPMN and Enterprise Architecture Profile (EAP) profile, which is a UML profile for TOGAF, and b) Archimate with UML and BPMN extensions which allow detailed modeling [321]. The Archi® is a modelling tool for enterprise architects and modelers, is based on **ArchiMate®** modelling language and The Open Group's ® standard aligned with TOGAF®, which amongst different views and viewpoints supports contains also Canvas Modelling Toolkit [322]. **Modelio**, an open-source extensible modeling environment, amongst other standards supports also ArchiMate, BPMN, UML and UML's EAP profile [323].

Here, examples of DIH value streams will be created, and the methodology will be the following:

1. value stream will be explained in short table, in respecting the [236];
2. the table will then be followed by the storyline description, in accordance with [236];
3. all stages of value stream will be explained graphically and in a table, in accordance with [236];
4. cross-mapping between necessary business capabilities from capability map will be linked to stages in value stream, in accordance with [264];
5. a model of a value stream will be created for all five chosen examples;
6. a DIH Value Stream Metamodel will be created based on five exemplary models.

An example of DIH Value stream, a digital skills acquisition, is shown on the Table 2. below.

Table 2. DIH Value Stream Example #1.

Name	<b>Digital skills acquisition</b>
Description	Activities involving problem specification, skill selection and the actual KT.
Stakeholder	SME
Value	SME able to determine the optimal solution and gaining DT knowledge for business optimization.

**Storyline for DIH Value stream example #1:**

1. Customer hears about DIH and decides to visit DIH's web page. On the web page, Customer can see entire portfolio of DIH's services/products/skills. This is the Advertising stage.



2. In DIH's portfolio displayed on the web page, Customer identifies the wanted service. This is specification stage.
3. Customer then decides to come to DIH office, asking for a certain digital skill necessary for the business digitalization, and the trainer then fully informs the Customer regarding chosen digital skill from the portfolio. This is display stage.
4. Customer then, with the help of trainer, chooses the right skill for his business. This is selection stage.
5. Trainer then teaches/educates/trains Customer about how to use/implement the skill. This is KT stage.
6. Then value streams will be divided into stages [264, p. 8]. Digital skills Acquisition Value Stream is composed of five stages explained above (Advertising, Specification, Display, Selection and KT).
7. Fig. 41. DIH Value Stream Example #1 Stages.
8. below shows the above explained DIH Value Stream example, elaborated through different value-creating stages.

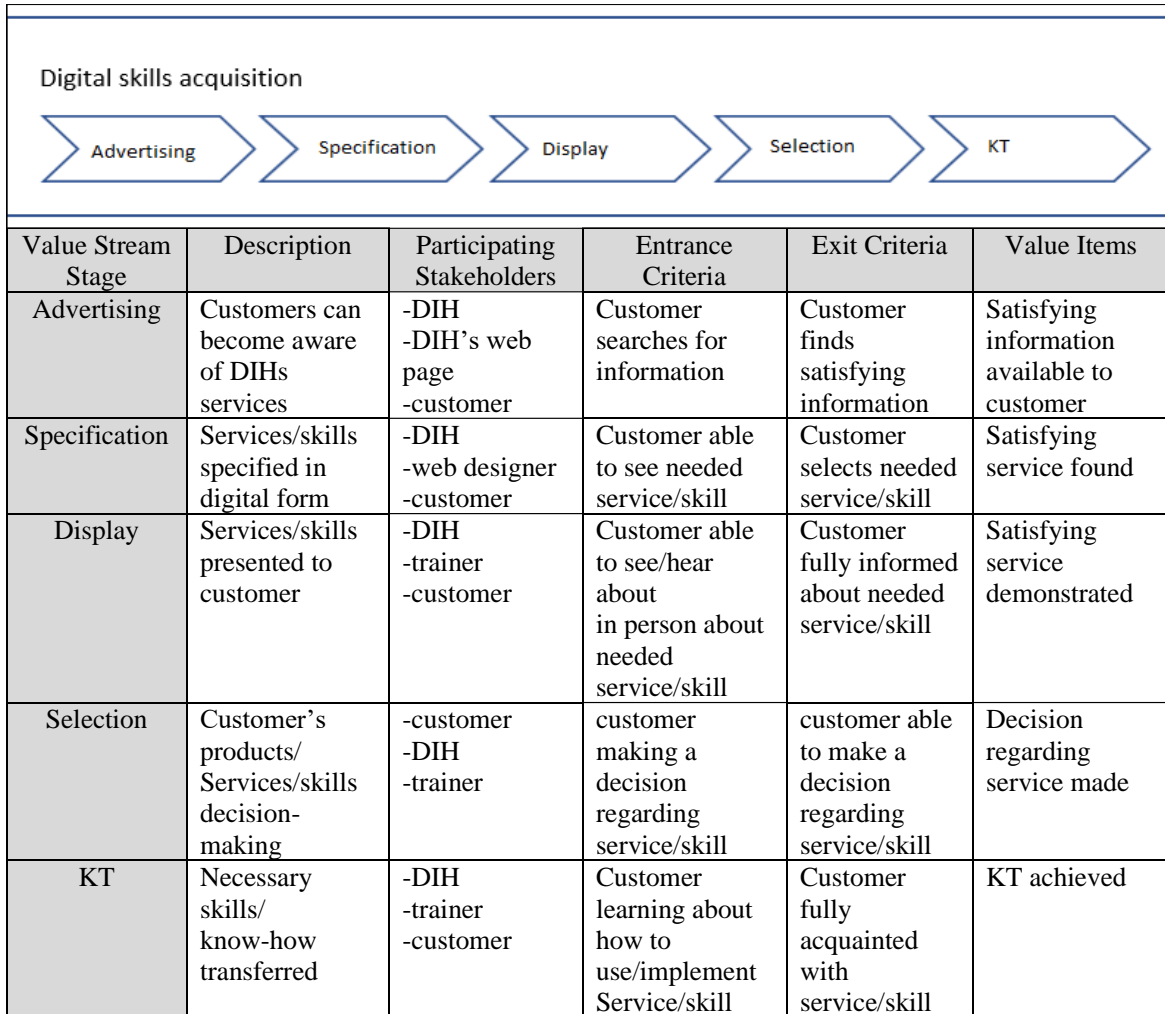

Fig. 41. DIH Value Stream Example #1 Stages.

- After value stream definition, cross-mapping between necessary business capabilities from capability map are linked to stages in value stream, in order to identify capabilities crucial for value delivery [264, p. 6]. That is depicted on Fig. 42. below, where can also be seen which managerial categories are needed for each stage; each Value Stream Stage having one or more Managerial Categories.

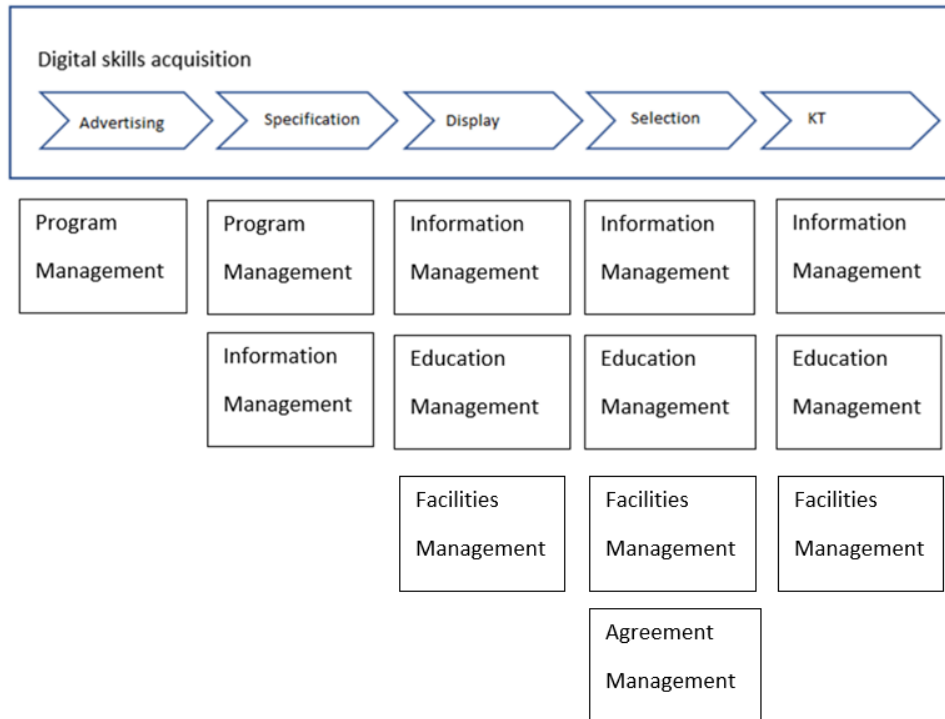

Fig. 42. DIH Cross-Mapping Value Stream Stages to Business Capabilities Example #1.

10. Having all this done, a model can be created- it is displayed on Fig. 43. below. DIH web page (which belongs to DIH) is a composition of information, one-to-many multiplicity, primarily regarding Services, Contacts and Products, where service class is a composition of digital skills class, all one-to-many multiplicity. DIH Portfolio is associated to the content of DIH Web page, which is associated to what a customer is going to be informed of, both one-to-many multiplicity. Trainer class is directly associated, one-to-many multiplicity, with customer, zero-to-one multiplicity. DIH is an aggregation of trainer class, one-to-many multiplicity. Information is associated to trainer class. Stages class is associated to managerial categories class and information class, and ValueStream class is a composition of Stages, one-to-many multiplicity.

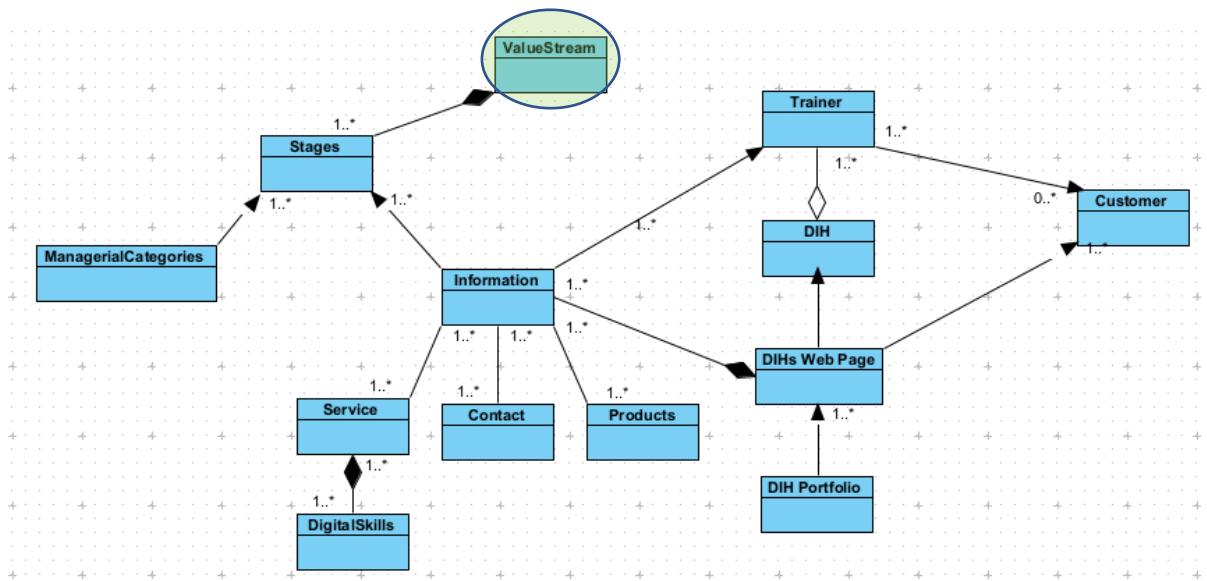

Fig. 43. DIH Value Stream Example #1 Model.

Some other examples of DIH value streams, their stages, and Cross-Mapping of Value Stream Stages to Business Capabilities, can be seen on the Table 3. below.

Table 3. DIH Value Stream Example #2.

Name	<b>Design of business plan for digitalization</b>
Description	Activities involving problem specification, business plan creation, and the actual KT.
Stakeholder	SME
Value	SME obtaining the optimal business plan for the digitalization of their business and learning how to implement it.

**Storyline DIH Value stream example #2:**

1. Customer hears about DIH and decides to visit DIH’s web page. On the web page, Customer can see entire portfolio of DIH’s services/products/skills. This is the Advertising stage.
2. In DIH’s portfolio displayed on the web page, Customer identifies the wanted service. This is display stage.
3. Customer then decides to come to DIH office, asking for a business plan solution necessary for the business digitalization, and the business architect then fully informs

the Customer regarding business plan customization options from the portfolio. This is customization stage.

4. Customer then, with the help of business architect, chooses the right business plan. This is selection stage.
5. Business architect then teaches/educates/trains Customer on how to implement the custom-made business plan. This is KT stage.
6. The next step in this process is to divide the value stream into stages [264, p. 8]. Design of business plan for digitalization Value Stream is composed of five stages explained above (Advertising, Display, Customization, Selection and KT). Fig. 44. below shows the above explained DIH Value Stream example, elaborated through different value-creating stages.

Design of business plan for digitalization					
Value Stream Stage	Description	Participating Stakeholders	Entrance Criteria	Exit Criteria	Value Items
Advertising	Customers can become aware of DIHs digitalization business solutions	-DIH -DIH's web page -customer	Customer searches for information	Customer finds satisfying information	Satisfying information available to customer
Display	Business solutions examples presented to customer	-DIH -business architect -customer	Customer able to see/hear about in person about business plan options	Customer fully informed about business plan options	Satisfying business plan options demonstrated
Customization	Business solutions examples tailor made for the customer	-DIH -business architect -customer	Customer able to see/hear about in person about	Customer fully informed about business plan customization options	Satisfying business plan customized option demonstrated

			business plan customization		
Selection	Customer deciding on the optimal business plan	-customer -DIH -business architect	customer making a decision regarding optimal custom made business plan solution	customer able to make a decision regarding optimal custom made business plan solution	Decision regarding optimal custom made business plan solution
KT	Necessary skills/ know-how transferred	-DIH -business architect -customer	Customer learning about how to implement business plan	Customer fully acquainted with the business plan	KT achieved

Fig. 44. DIH Value Stream Example #2 Stages.

- After value stream definition, cross-mapping between necessary business capabilities from capability map are linked to stages in value stream, in order to identify capabilities crucial for value delivery [264, p. 6]. That is depicted on Fig. 45. below, where can also be seen which managerial categories are needed for each stage; each Value Stream Stage having one or more Managerial Categories.

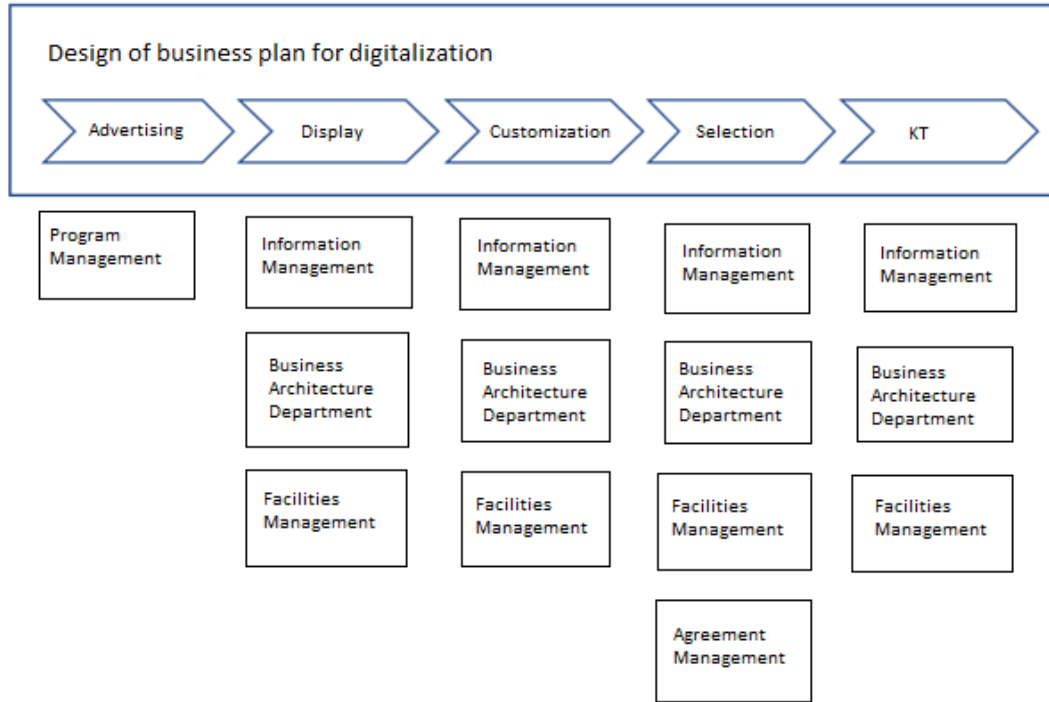

Fig. 45. DIH Cross-Mapping Value Stream Stages to Business Capabilities Example #2.

8. Having all this done, a model can be created- it is displayed on Fig. 46. below. DIH web page (which belongs to DIH) is a composition of information, one-to-many multiplicity, primarily regarding Services, Contacts and Products, where service class is a composition of digital business plan option class, all one-to-many multiplicity. DIH Web page is directly associated to what a customer is going to be informed of, both one-to-many multiplicity. Business architect class is directly associated, one-to-many multiplicity, with customer, zero-to-one multiplicity. DIH is an aggregation of business architect class, one-to-many multiplicity. Information is also directly associated to business architect class. Stages class is directly associated to managerial categories class and information class, whilst ValueStream class is a composition of Stages, one-to-many multiplicity.

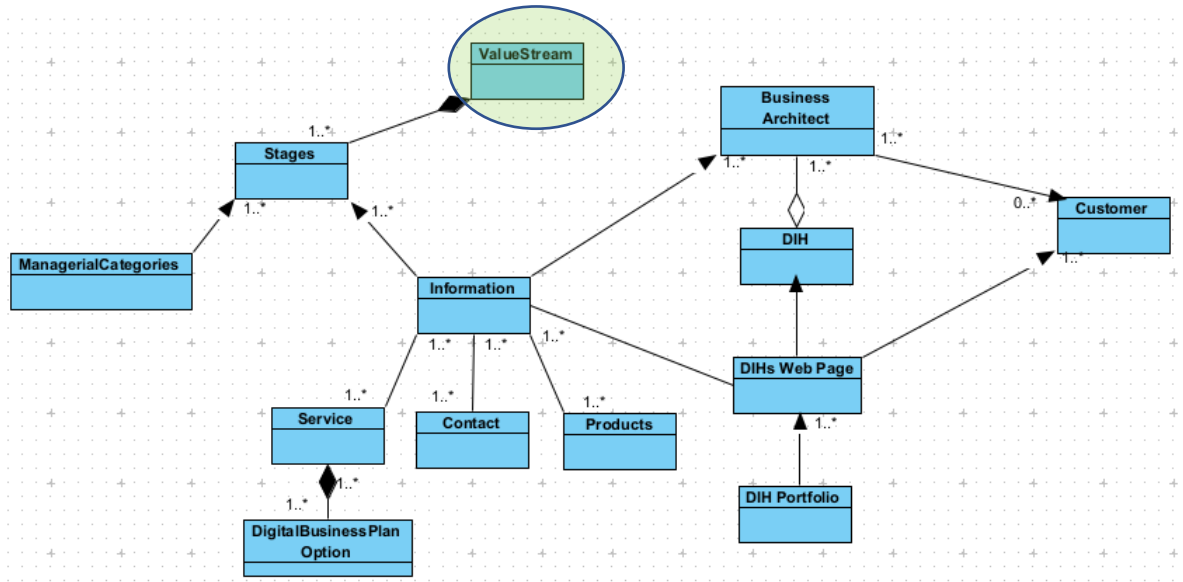

Fig. 46. DIH Value Stream Example #2 Model.

Another DIH value stream example could be regarding matchmaking solutions, and can be seen on the Table 4. DIH Value Stream Example #3. Table 4. below.

Table 4. DIH Value Stream Example #3.

Name	<b>Matchmaking with appropriate business partner</b>
Description	Activities involving problem statement, matchmaking, and synergy resulting from a fruitful partnership
Stakeholder	SME
Value	SME being matched with the best available business partner

### Storyline DIH Value stream example #3:

1. Customer hears about DIH and decides to visit DIH's web page. On the web page, Customer can see entire portfolio of DIH's services/products/skills. This is the Advertising stage.
2. In DIH's portfolio displayed on the web page, Customer identifies the wanted service. This is display stage.
3. Customer then decides to come to DIH office, asking for a matchmaking solution necessary for the business digitalization, and the market expert then fully informs the Customer regarding matchmaking options from the portfolio. This is selection stage.



4. Customer then, with the help of market expert, chooses the right partner to be matched with. Partner company then also comes to DIH office and they agree to work together. This is matchmaking stage.
5. Market expert then teaches/educates/trains Customer about future *modus operandi* with the partner company. This is KT stage.
6. The next step in this process is to divide the value stream into stages [264, p. 8]. Design of business plan for digitalization Value Stream is composed of five stages explained above (Advertising, Display, Selection, Matchmaking and KT). Fig. 47. below shows the above explained DIH Value Stream example, elaborated through different value-creating stages.

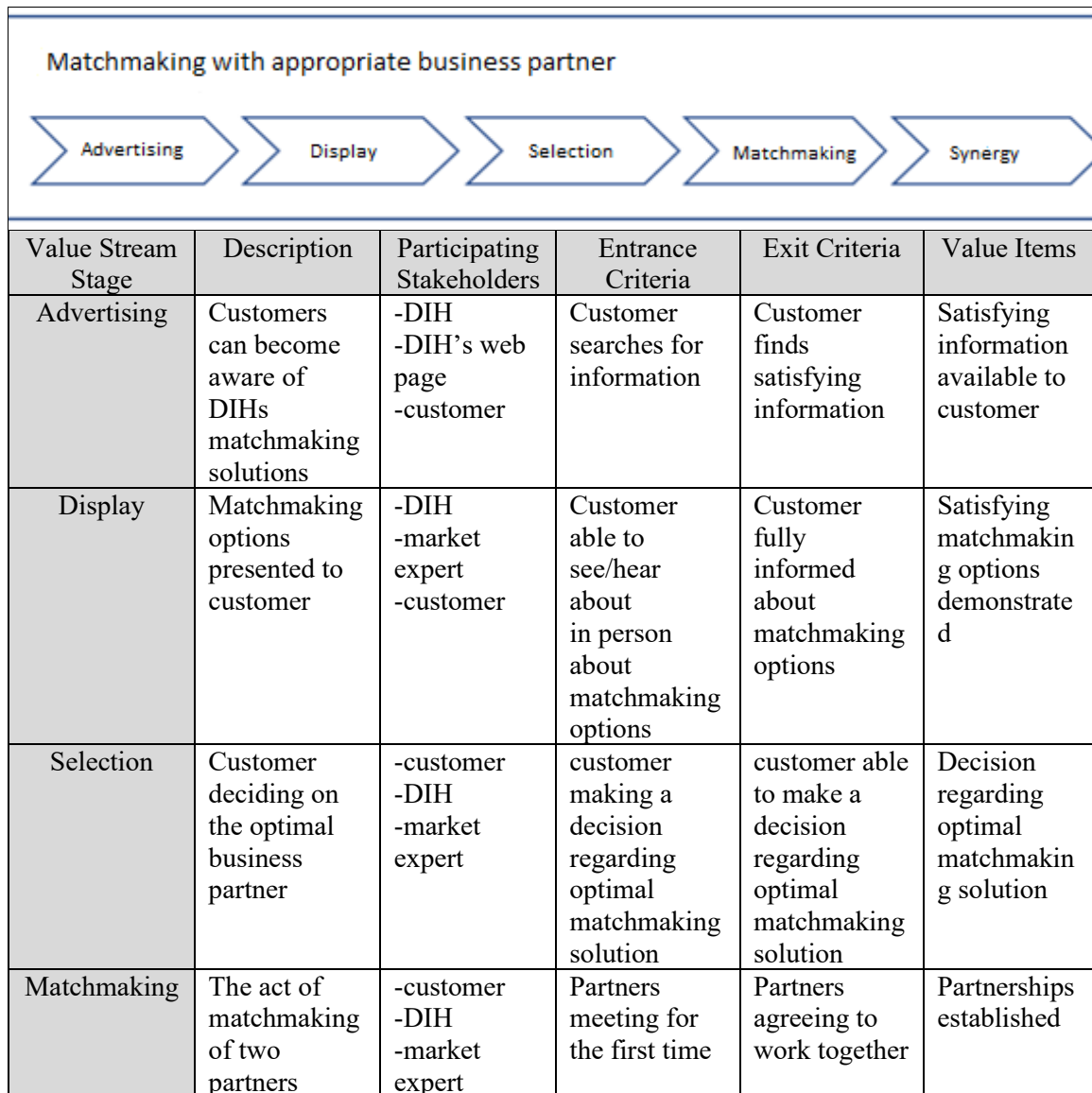

		-partner company			
Synergy	Added value resulting from the two matched partners	-DIH - market expert -partner company -customer	Customer learning about future <i>modus operandi</i> with the partner company	Customer fully acquainted with matched partner <i>modus operandi</i>	Synergy achieved

Fig. 47. DIH Value Stream Example #3 Stages.

- After value stream definition, cross-mapping between necessary business capabilities from capability map are linked to stages in value stream, in order to identify capabilities crucial for value delivery [264, p. 6]. That is depicted on Fig. 48. below, where can also be seen which managerial categories are needed for each stage; each Value Stream Stage having one or more Managerial Categories.

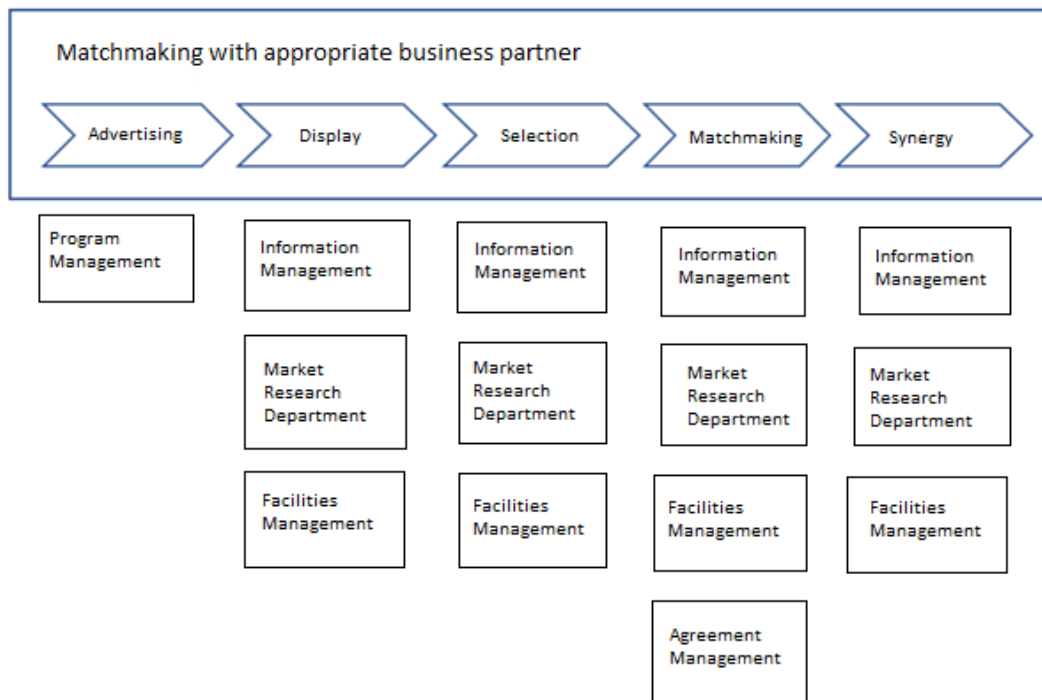

Fig. 48. DIH Cross-Mapping Value Stream Stages to Business Capabilities Example #3.

8. Having all this done, a model can be created- it can be seen on Fig. 49. below. DIH web page (which belongs to DIH) is a composition of information, one-to-many multiplicity, primarily regarding Services, Contacts and Products, where service class is a composition of matchmaking solution class, all one-to-many multiplicity. DIH Portfolio is directly associated with content on the DIH Web page, which defines what a customer is going to be informed of, both one-to-many multiplicity. Market expert class is directly associated, one-to-many multiplicity, with customer, zero-to-one multiplicity. DIH is an aggregation of market expert class, one-to-many multiplicity. Information is also directly associated with MarketExpert class. Stages class is directly associated to ManagerialCategories class and Information class, and ValueStream class is a composition of Stages, one-to-many multiplicity.

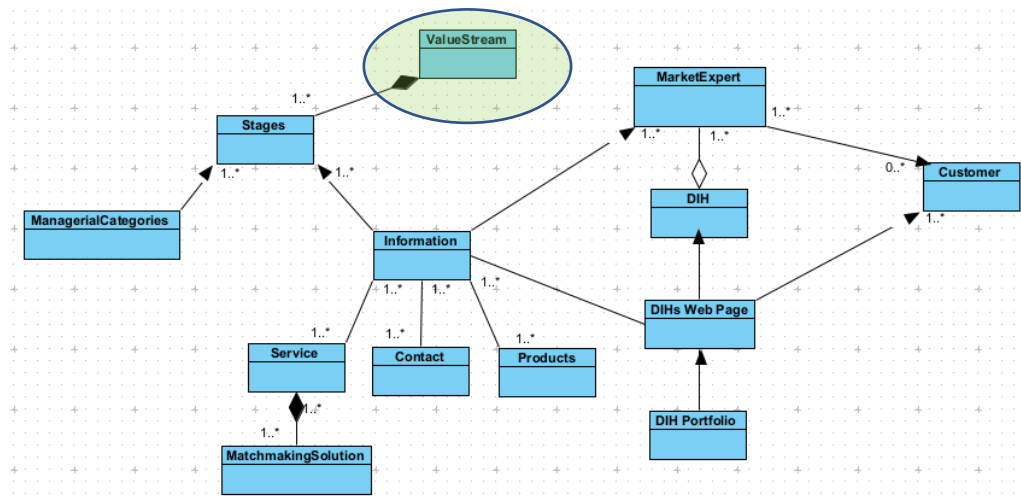

Fig. 49. DIH Value Stream Example #3 Model.

Acquisition of new technology is also a DIH value stream example, which can be seen on the Table 5. below.

Table 5. DIH Value Stream Example #4.

Name	<b>Acquisition of new technology</b>
Description	Activities involving problem statement, new technology selection, TT
Stakeholder	SME
Value	SME's acquisition of new technology

**Storyline DIH Value stream example #4:**

1. Customer hears about DIH and decides to visit DIH’s web page. On the web page, Customer can see entire portfolio of DIH’s services/products/skills. This is the Advertising stage.
2. In DIH’s portfolio displayed on the web page, Customer identifies the wanted service. This is displaying stage.
3. Customer then decides to come to DIH office, asking for a new technology necessary for the business digitalization, and the technology expert then fully informs the Customer regarding technology implementation options from the portfolio. This is selection stage.
4. Technology expert then teaches/educates/trains Customer about all that’s needed to know regarding the new technology. This is mentoring stage.
5. Technology expert then teaches/educates/trains Customer about the new technology, especially on the ways of implementation and usage. This is TT stage.
6. The next step in this process is to divide the value stream into stages [264, p. 8]. Design of business plan for digitalization Value Stream is composed of five stages explained above (Advertising, Display, Selection, Mentoring and TT). Fig. 50. below shows the above explained DIH Value Stream example, elaborated through different value-creating stages.

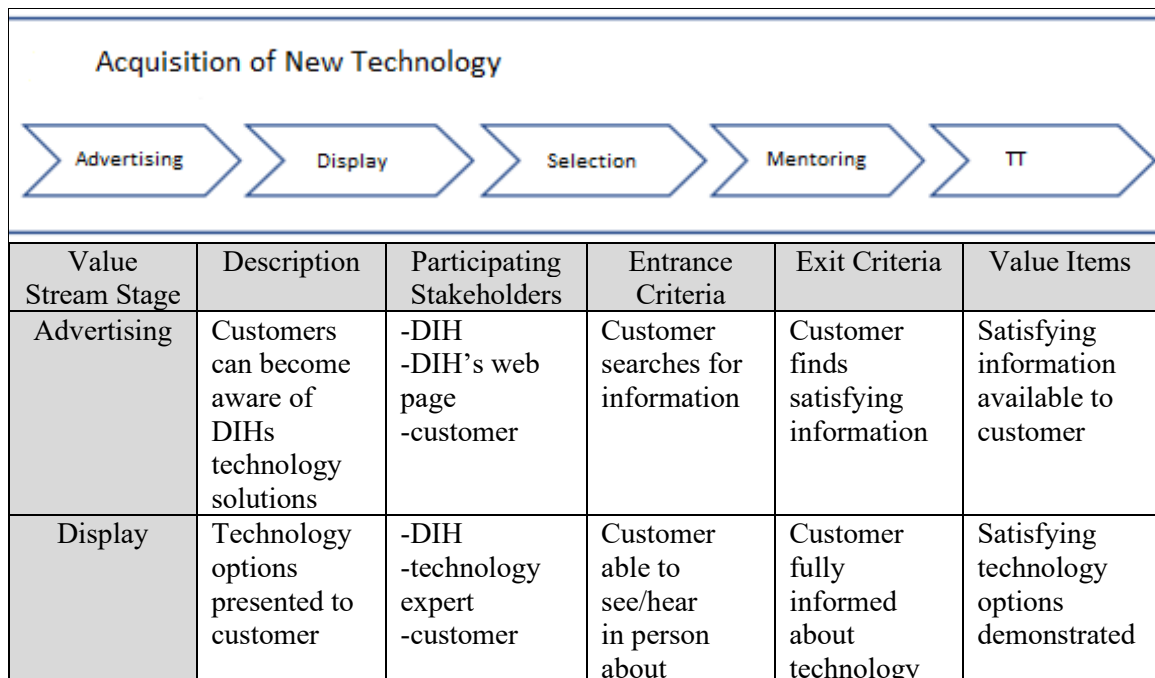

			technology options	options	
Selection	Customer deciding on the optimal technology needed	-customer -DIH -technology expert	Customer making a decision regarding optimal technical solution	Customer able to make a decision regarding optimal technical solution	Decision regarding optimal technical solution
Mentoring	The act of teaching customer about and how to use the new technology	-customer -DIH - technology expert	Customer seeing the new technology for the first time	Customer Choosing the right technology	New technology chosen
TT	Technology being transferred to a new customer	-DIH - technology expert -customer	Customer learning about the new technology and how to implement it	Customer fully acquainted with the new technology	TT achieved

Fig. 50. DIH Value Stream Example #4 Stages.

7. After value stream definition, cross-mapping between necessary business capabilities from capability map are linked to stages in value stream, in order to identify capabilities crucial for value delivery [264, p. 6]. That is depicted on Fig. 51. below, where can also be seen which managerial categories are needed for each stage; each Value Stream Stage having one or more Managerial Categories.

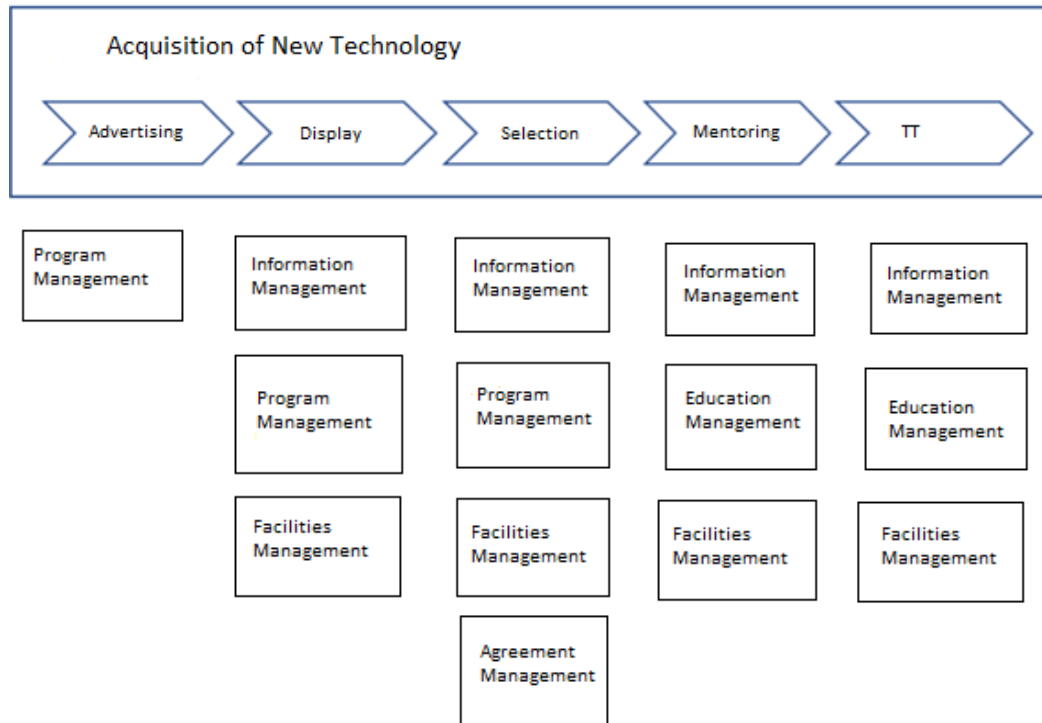

Fig. 51. DIH Cross-Mapping Value Stream Stages to Business Capabilities Example #4.

8. Having all this done, a model can be created- it can be seen on Fig. 52. below. DIH web page (which belongs to DIH) is a composition of information, one-to-many multiplicity, primarily regarding Services, Contacts and Products, where service class is a composition of tech solution class, all one-to-many multiplicity. DIH Portfolio is directly associated with the content of the DIH Web page, which displays what a customer is going to be informed of, both one-to-many multiplicity. Technology expert class is directly associated, one-to-many multiplicity, with customer, zero-to-one multiplicity. DIH is an aggregation of technology expert class, one-to-many multiplicity. Information is also directly associated to TechnologyExpertClass. Stages class is defined by managerial Categories class and Information class, and ValueStream class is a composition of Stages, one-to-many multiplicity.

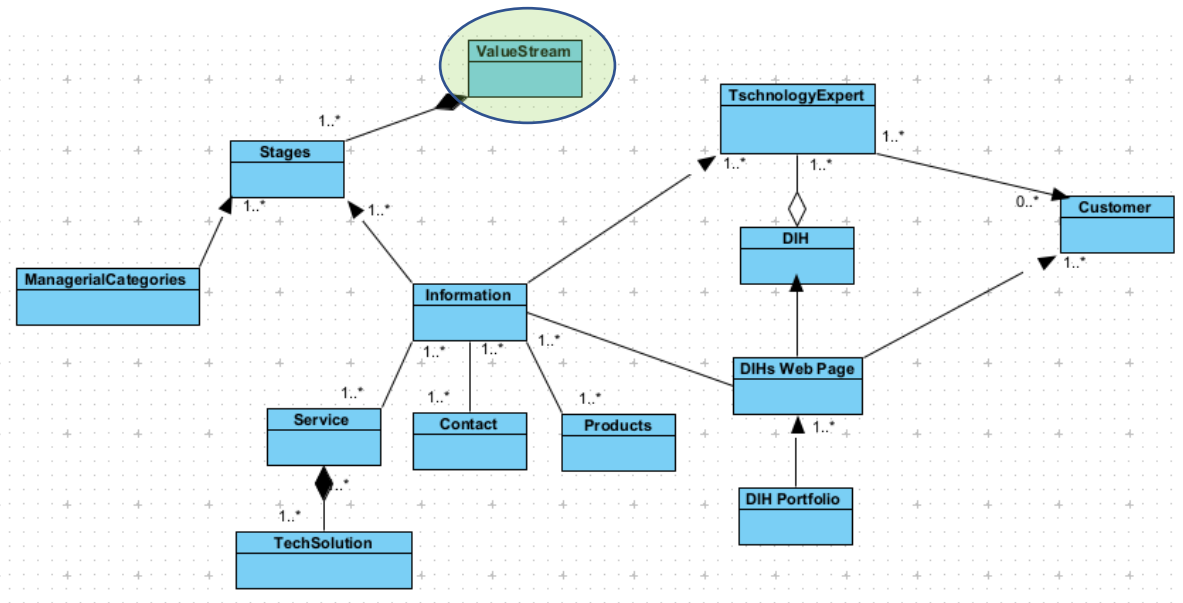

Fig. 52. DIH Value Stream Example #4 Model.

The next DIH Value Stream example is regarding obtaining the necessary information, and can be seen on the Table 6. below.

Table 6. DIH Value Stream Example #5.

Name	<b>Obtaining information regarding business processes digitalization</b>
Description	Activities involving problem statement, information offered, KT
Stakeholder	SME
Value	SME obtains required information

**Storyline DIH Value stream example #5:**

1. Customer hears about DIH and decides to visit DIH’s web page. On the web page, Customer can see entire portfolio of DIH’s services/products/skills. This is the Advertising stage.
2. In DIH’s portfolio displayed on the web page, Customer identifies the wanted information. This is display stage.
3. Customer then decides to come to DIH office, asking for a new technology necessary for the business digitalization, where technology expert and business architect fully inform the Customer regarding business process optimization information. This is demonstration stage.

4. Technology expert and business architect then teach/educate/train Customer about all that's needed to know regarding the business process optimization information. This is mentoring stage.
5. Technology expert and business architect then teach/educate/train Customer about the all that's needed to know; how to implement the information in business and how to use optimize it. This is KT stage.
6. The next step in this process is to divide the value stream into stages [264, p. 8]. Design of business plan for digitalization Value Stream is composed of five stages explained above (Advertising, Display, Demonstration, Mentoring and KT). Fig. 53. below shows the above explained DIH Value Stream example, elaborated through different value-creating stages.

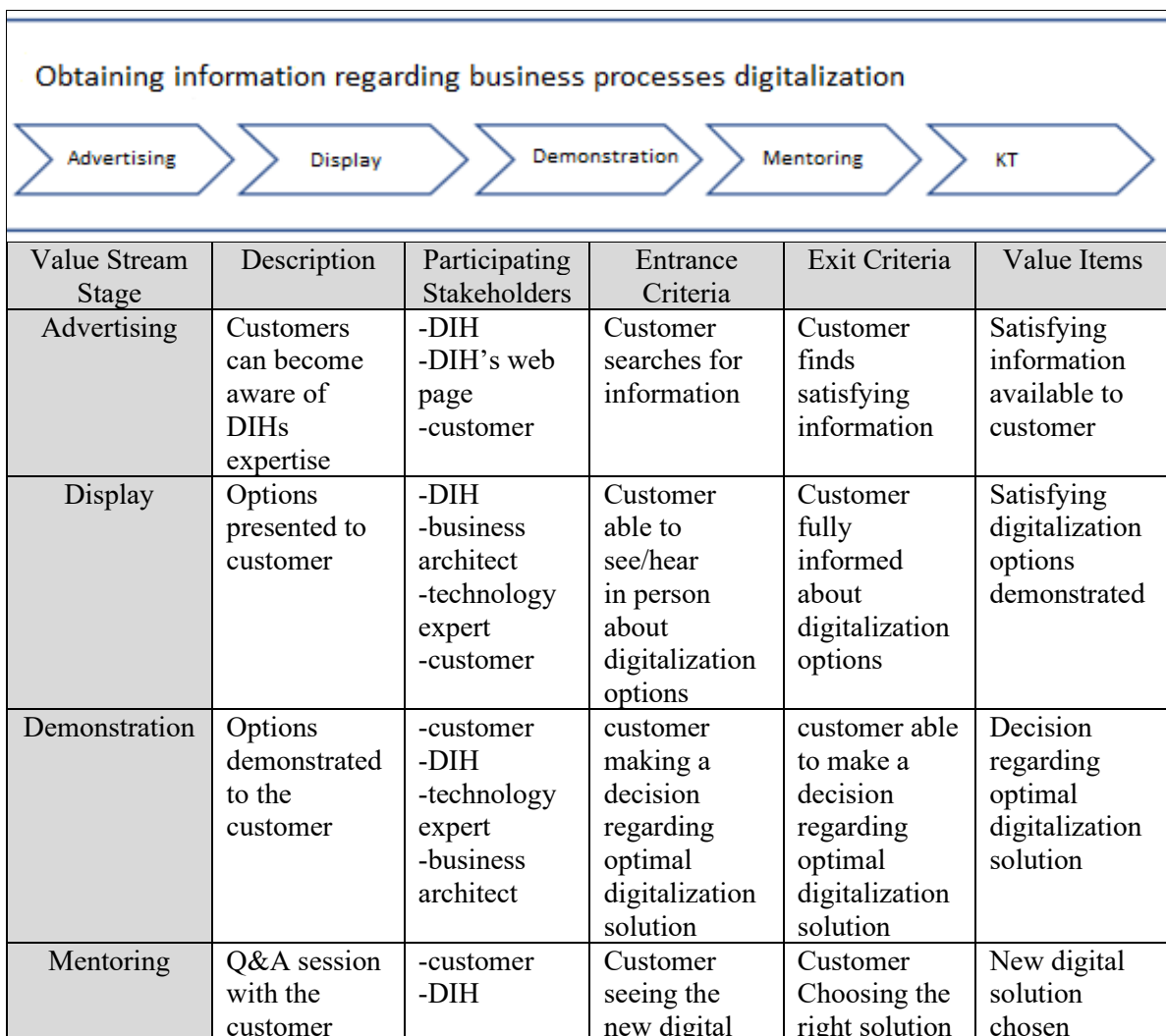



		-technology expert -business architect	options for the first time		
KT	Knowledge being transferred to a new customer	-DIH -technology expert -business architect -customer	Customer learning about the new digital options and how to implement it	Customer fully acquainted with the new digital options	KT achieved

Fig. 53. DIH Value Stream Example #5 Stages.

- After value stream definition, cross-mapping between necessary business capabilities from capability map are linked to stages in value stream, in order to identify capabilities crucial for value delivery [264, p. 6]. That is depicted on Fig. 54. below, where can also be seen which managerial categories are needed for each stage; each Value Stream Stage having one or more Managerial Categories.

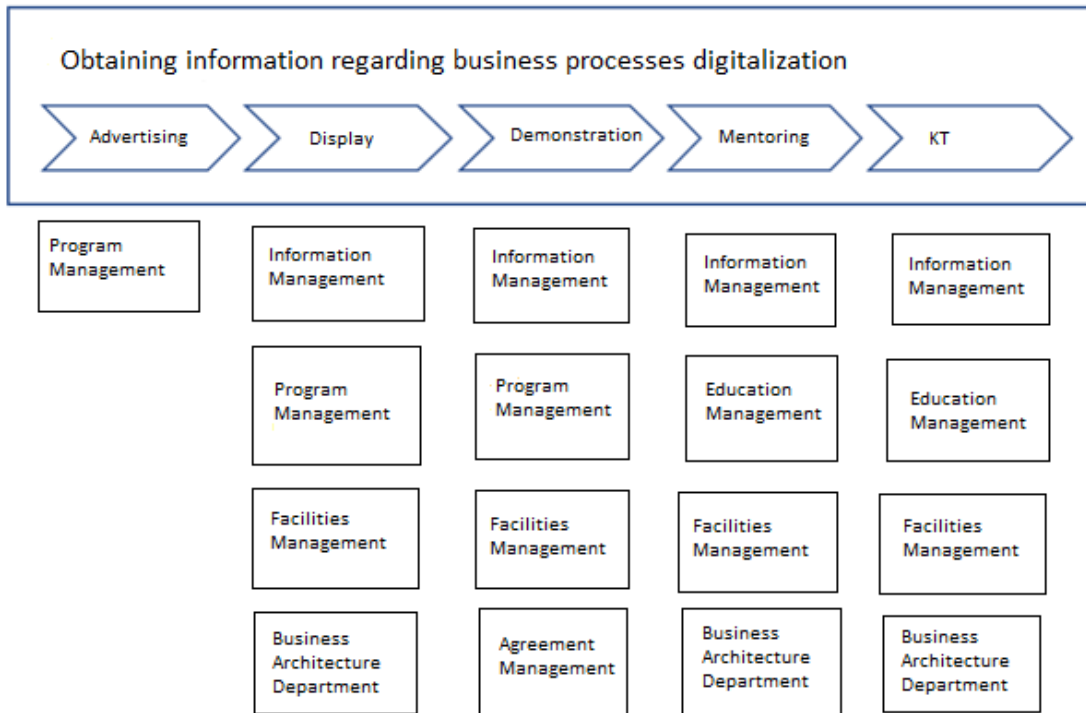

Fig. 54. DIH Cross-Mapping Value Stream Stages to Business Capabilities Example #5.

8. Having all this done, a model can be created- it can be seen on Fig. 55. below. DIH web page (which belongs to DIH) is a composition of information, one-to-many multiplicity, primarily regarding Services, Contacts and Products, where service class is a composition of DigiSolution class, all one-to-many multiplicity. DIH Portfolio is directly associated to what is going to be on the DIH Web page, which defines what a customer is going to be informed of, both one-to-many multiplicity. TechnologyExpert class and BusinessArchitect class are directly associated, one-to-many multiplicity, and with customer, zero-to-one multiplicity. DIH is an aggregation of TechnologyExpert class and BusinessArchitect class, one-to-many multiplicity. Information also defines TechnologyExpert class and BusinessArchitect class. TechnologyExpert class and BusinessArchitect class are associated, one-to-many multiplicity. Stages class is defined by ManagerialCategories class and Information class. ValueStream class is a composition of Stages, one-to-many multiplicity.

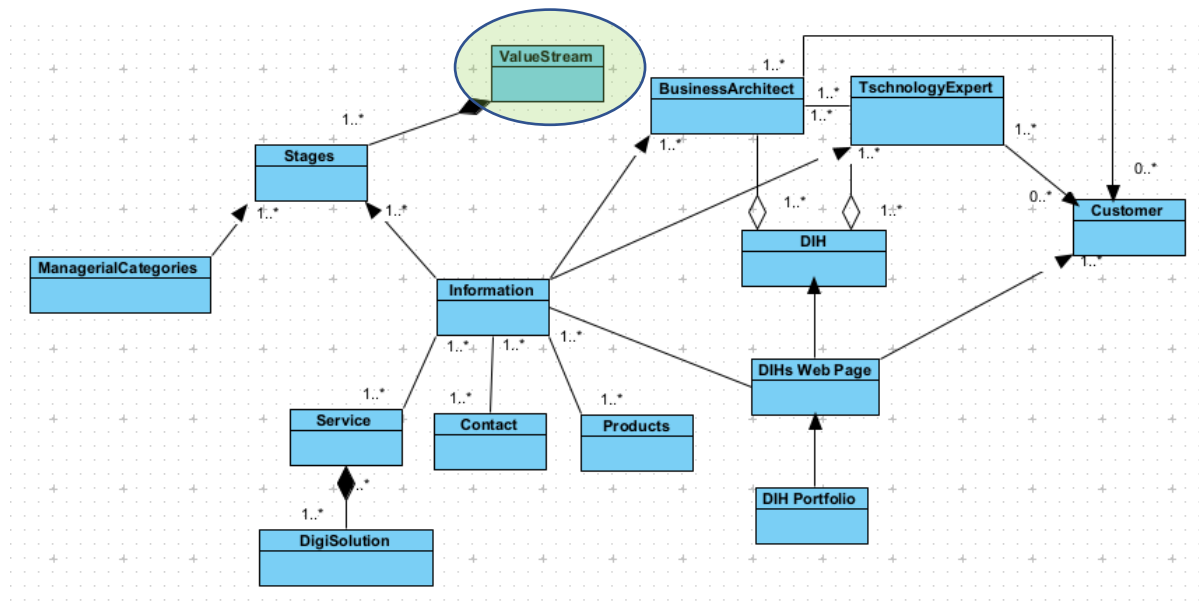

Fig. 55. DIH Value Stream Example #5.

Based on all the above DIH Value Stream models, DIH Value Stream Metamodel was created and can be seen on the Fig. 56. below. DIH web page (which belongs to DIH) is in the Mediator metaclass, such also contains other possible mediating options (such as DIH’s advertisements,

radio announcements etc.) through which a Client/customer approaches/learns about DIH. Mediator metaclass has information primarily regarding DIHs Services, Contacts and Products. ServiceInfo metaclass contains information regarding digital skills, digitalization business plan options, matchmaking solutions, technical solutions and digital solutions. ValueStream metaclass is a composition of Stages metaclass which contains all the necessary information regarding all the stages and information regarding managerial categories involved in each stage. Different experts which assist Customer upon arrival in DIH office are covered by DIHStaff metaclass. The rest of the metamodel follows the logic of the previous Value Stream models.

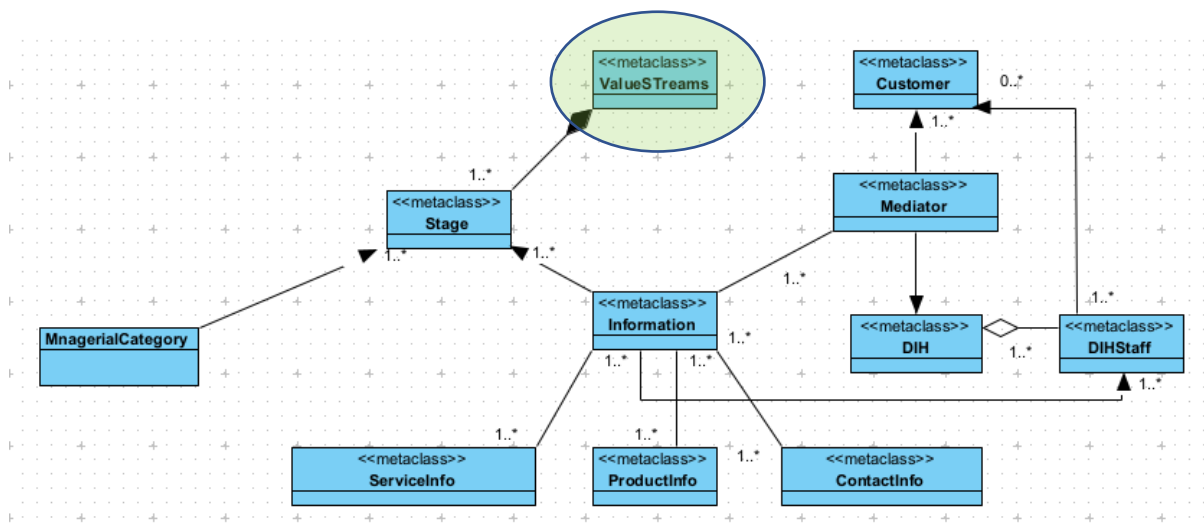

Fig. 56. DIH Value Stream Metamodel.

Five examples of DIH value streams were explained, which is possible to create following the methodology which describes value streams, creates storyline description, graphically and in table explains stages of a value stream conducts cross-mapping between necessary business capabilities from capability map and links them to stages in value stream, creates a model of a value stream, and finally creates a DIH Value Stream Metamodel based on those five exemplary models.

### 5.2.10.Resource- Event- Agent

REA ontology is based on an assumption that in given circumstances, collaborations may be broken down in series of binary collaborations between numerous business entities, describing the following: (R) resources (E) economic events (triggers of economic exchanges), and (A) all involved agents [289, p. 1]. The same source further states that REA concepts reflect double-entry accounting book keeping logic, which was replaced with economic conversions and exchanges semantic models, in which business transactions are events through which two agents exchange resources [289, p. 2].

This is also performed in order to establish weather mapping between VDML and other methods is possible, in this case VDML and REA. VDML DIH concepts mapped onto REA are contained in Table 33. in Appendix 3. Mapping is conducted in accordance with OMG's VDML specification [19, pp. 105-106]. The following section 5.5.11. discusses REA model and metamodel.

### 5.2.11.REA Model and Metamodel

The storyline of REA would be the following:

1. REA shows “relationships between economic resources, economic events and economic agents” [19, p. 103], so **resource, event and agent classes** will be drawn in gray color, resource and agent class will be associated to event class with multiplicities one-to-many on both sides.
2. Since for REA is specific that “Duality also represents causality relationship” [19, p. 103], and will be depicted as **reflexive association** on the event class (to emphasize the sequence) [324, p. 124].
3. The REA model has to contain “REA basic categories including location” [324, p. 124], so **location class** was also added in accordance with the source also taking into account the following two statements: “events can be assigned to a location” [324, p. 124] and “Locations can be considered as a special kind of resource” [324, p. 124].

Location class is directly associated to event class with one-to-many multiplicities on both ends.

4. Since “every REA model must specify who are the provider and recipient of every exchanged resource” [19, p. 104], **provider and recipient classes** will be associated to resource class with multiplicities one-to-many on both ends; resource class will be directly associated with recipient class, and provider class will be directly associated to resource class.
5. REA also encompasses “concepts for describing what could or should happen, i.e., commitments, contracts, schedules and policies” [19, p. 104], so classes **commitment, contract, schedule** and **policy** will define agent class with one-to-many multiplicities.
6. Since these statements are given “A resource is any object that is under control of an agent and regarded as valuable by some agent. The value can be monetary or of an intangible nature, such as status, health state, and security.” [324, p. 124], **classes monetary** and **intangible** will be drawn as child classes of resource class, with multiplicities one-to-many.
7. Since the following statement is given “An exchange process occurs as two agents exchange resources.” [324, p. 124], class **exchange** will be associated with agent and resource classes with multiplicity zero-to-many on all sides.
8. Since the following statement is given “agent is an individual or organization” [324, p. 124], **individual** and **organization classes** will be drawn as child classes to agent class, with one-to-many and zero-to-many multiplicities respectively.

Based on this REA storyline, REA model was created and can be seen on Fig. 57. below, based on [19] and [324]. Class Commitment is highlighted because it maps onto Value Proposition class of VDML [19, p. 105].

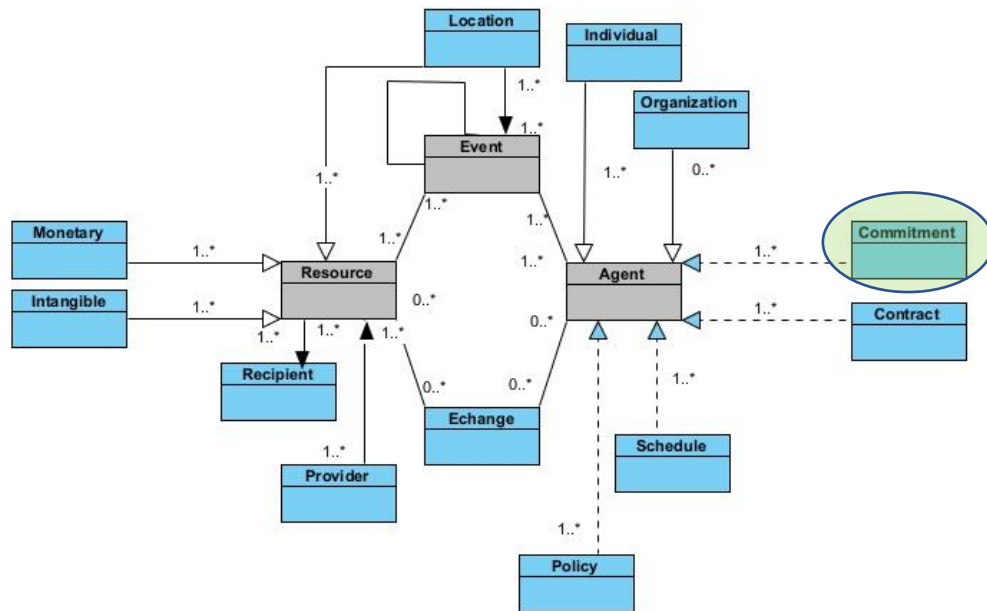

Fig. 57. REA Model.

Metamodel of REA model can be seen on Fig. 58. below. Operational level elements are of white color and policy level elements are depicted in gray color [325, p. 222]. Classes Resource, Event and Agent from REA model above are in REA metamodel below depicted as metaclasses. Agent Type, Event Type and Resource Type of a REA metamodel contain classes which are in REA model associated to Agent, Event and Resource classes. And then, Exchange class from REA model is contained in Increment Event, Decrement Event and Duality metaclasses. Also, REA metamodel contains much more detailed information, covering different aspects of various REA models it covers.

Legend for the Fig. 58. below is therefore the following:

1. white color - Operational level elements
2. gray color - Policy level elements

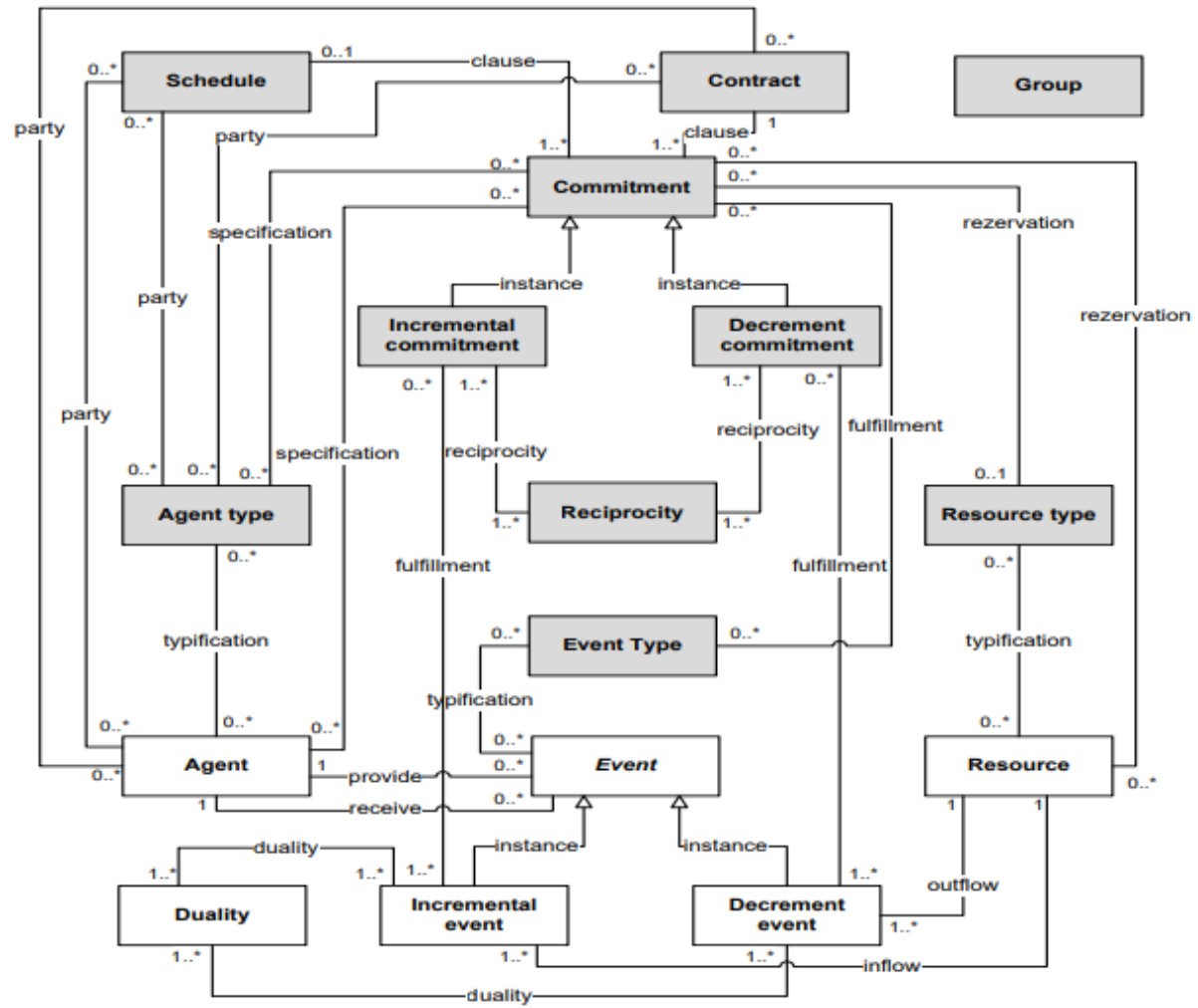

Fig. 58. Metamodel of REA Model. Source: [325, p. 222].

The storyline of this metamodel would be the following:

1. Event class is generalization for DecrementEvent class and IncrementalEvent class. Zero-to-many Event classes are associated with one Agent class (one such association is for providing and one is for receiving). Zero-to-many Event classes are associated to Zero-to-many EventType classes.
2. One-to-many IncrementalEvent classes are associated with one Resources class, zero-to-many IncrementalCommitment classes, and one-to-many Duality classes. One-to-many Duality classes are associated with one-to-many DecrementEvent classes. One-to-many DecrementEvent classes are associated with one Resource class. Zero-to-many Resource classes are associated with zero-to-many ResourceType classes and zero-to-many Commitment classes.
3. Zero-to-many Agent classes are associated to zero-to-many Contract classes, zero-to-many Schedule classes, zero-to-many AgentType classes, and zero-to-many Commitment classes.
4. Zero-to-many EventType classes are associated with zero-to-many Commitment classes. Zero-to-many AgentType classes are associated with zero-to-many Schedule classes, Contract classes, and Commitment classes. One-to-many Reciprocity classes are associated with one-to-many IncrementalCommitment classes and DecrementCommitment classes. Zero-to-one ResourceType classes are associated with zero-to-many Commitment classes.
5. IncrementalCommitment class and DecrementCommitment class are instances of Commitment class. One-to-many Commitment classes are associated with zero-to-one Schedule classes and one Contract class.

VDML concepts mapping onto REA concepts is possible, and the mapping logic is the following: Business Network maps onto Business Process, Contract and Exchange; Value Proposition maps onto Commitment; Duality maps onto Duality; Store of Capability maps onto Economic Resource; Party Role (Business Network) maps onto Economic Agent; Activity maps onto Economic Event; Capability Method or Practice maps onto Policy; Deliverable flow (Role) maps onto Provide and Receive; Deliverable Flow (Store) maps onto Stockflow; Role Association maps onto Responsibility; and Value maps onto Value [326].



To conclude, it is safe to say that it is possible to map VDML DIH concepts onto REA ontology, and that REA model and a metamodel are possible to create.

#### 5.2.12. e<sup>3</sup>value

e<sup>3</sup>value models depict actors exchanging value during contract period, the main protagonists being value transfers, actors, value object, start stimuli and dependency paths, while most elements have numerous attributes [327]. This exchange is based on the principle of reciprocity, where actors engaged in value activities offer a value offering of some sort, a value object, and receive it in return; actors demonstrate their exchange intent through value ports, which can be grouped into value interfaces [328, pp. 2-3]. The purpose of e<sup>3</sup>-value modeling technique is value exchange modeling in e-business network, which consists of multiple business entities [289, p. 1].

e<sup>3</sup>value tool can create e<sup>3</sup>value models, and also conduct analyses of Net Value Flow [329]. VDML DIH concepts mapped onto e<sup>3</sup>value is performed in order to establish whether mapping between VDML and other methods is possible, in this case onto e<sup>3</sup>value. The results are contained in Table 34. in Appendix 3. Mapping is conducted in accordance with OMG's VDML specification [19, pp. 106-107]. The following section 5.2.13. discuss e<sup>3</sup>value Model and Metamodel and VDML concepts mapping onto e<sup>3</sup>value concepts.

#### 5.2.13. e<sup>3</sup>value Model and Metamodel

The storyline of e<sup>3</sup>value would be the following:

1. In the e<sup>3</sup>value model, “actors are profit-loss responsible entities, such as organizations, customers and intermediaries” [327], so **Actor class** will be directly associated to **Organization, Customer and Intermediary classes**, multiplicities being one-to-many.
2. Since “A Market segment is used to represent a group of similar actors” [327], **MarketSegment class** will be directly associated to Actor class with one-to-many multiplicity.

3. Value transfer is also very important element in e3value model, and it falls under “transfers of value objects” [327], so **ValueOffering class** will be connected to **ValueObject** class. Since “all the lines between two actors are value transfers” [327], value transfer class will be connected to actor class with one-to-many multiplicity.
4. Also, “each transfer has an associated valuation” [327], so **ValuationClass** defines value transfer class.
5. The value object element is composed of “things of economic value which can be exchanged, such as money, services, products, knowledge or experiences” [327], so **classes Money, Service, Product, Knowledge and Experience** will be drawn as child classes to value object class; Product, Money and Service classes having zero-to-many multiplicity, Knowledge and Money classes having one-to-many multiplicities.
6. Since “dependency paths are chains of economic transactions” [327], **DependencyPath class** will be associated with value transfer class with one-to-many multiplicity.
7. Also, since “two dependency paths: one for the subscription and one for the calling” [327], **Subscription class** with zero-to-many dependency and **Calling classes** with one-to-many dependency will be directly associated to DependencyPath class.
8. StartStimuli element role is to “trigger a chain of economic transactions” [327]. Therefore, **StartStimuli class** is associated to ValueTransfer class with multiplicity one-to-many.

Based on this e3value storyline, model was created and can be seen on Fig. 59. below, based on [327]. Value Offering class was highlighted here also, as it maps to ValueProposition class of VDML [19, p. 107].

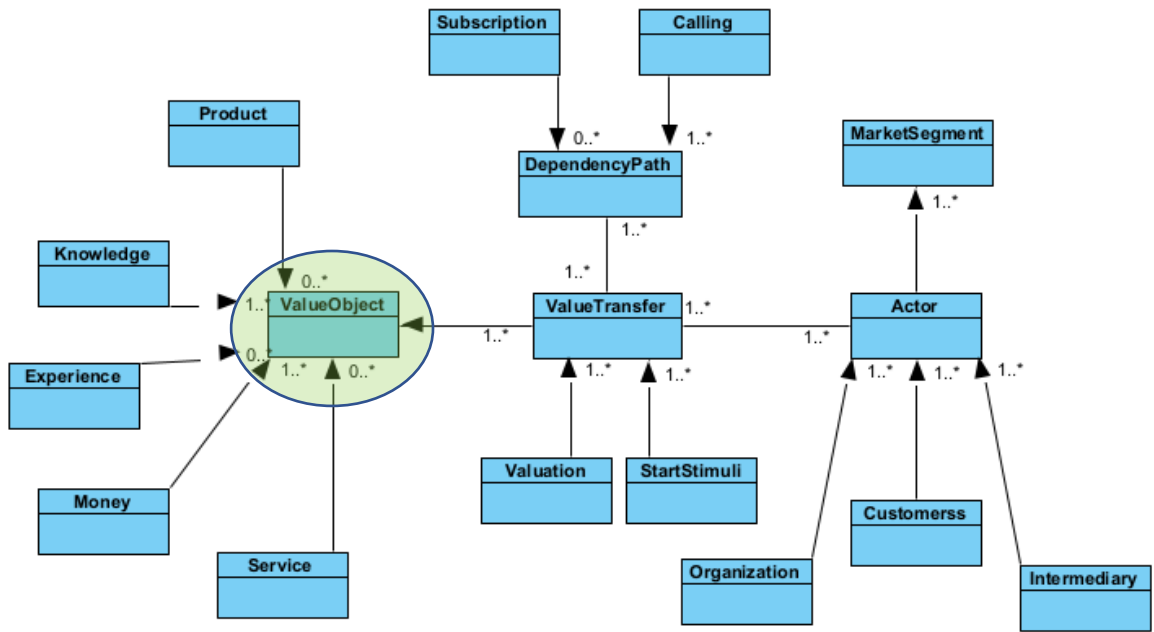

Fig. 59. e3value Model.

e<sup>3</sup>value metamodel created by a researcher in her master's thesis can be seen on the Fig. 60. below. Value Offering class with all its associated classes of e3value move depicted above is contained in Value Object metaclass of REA metamodel depicted below. Value Transfer class with all its associated classes is contained in Value Transfer and Value Exchange metaclasses and their associated metaclasses. Actor class and its associated classes are contained in Acor metaclass. REA metamodel below contains much more detail the REA model above, as it covers various different REA models.

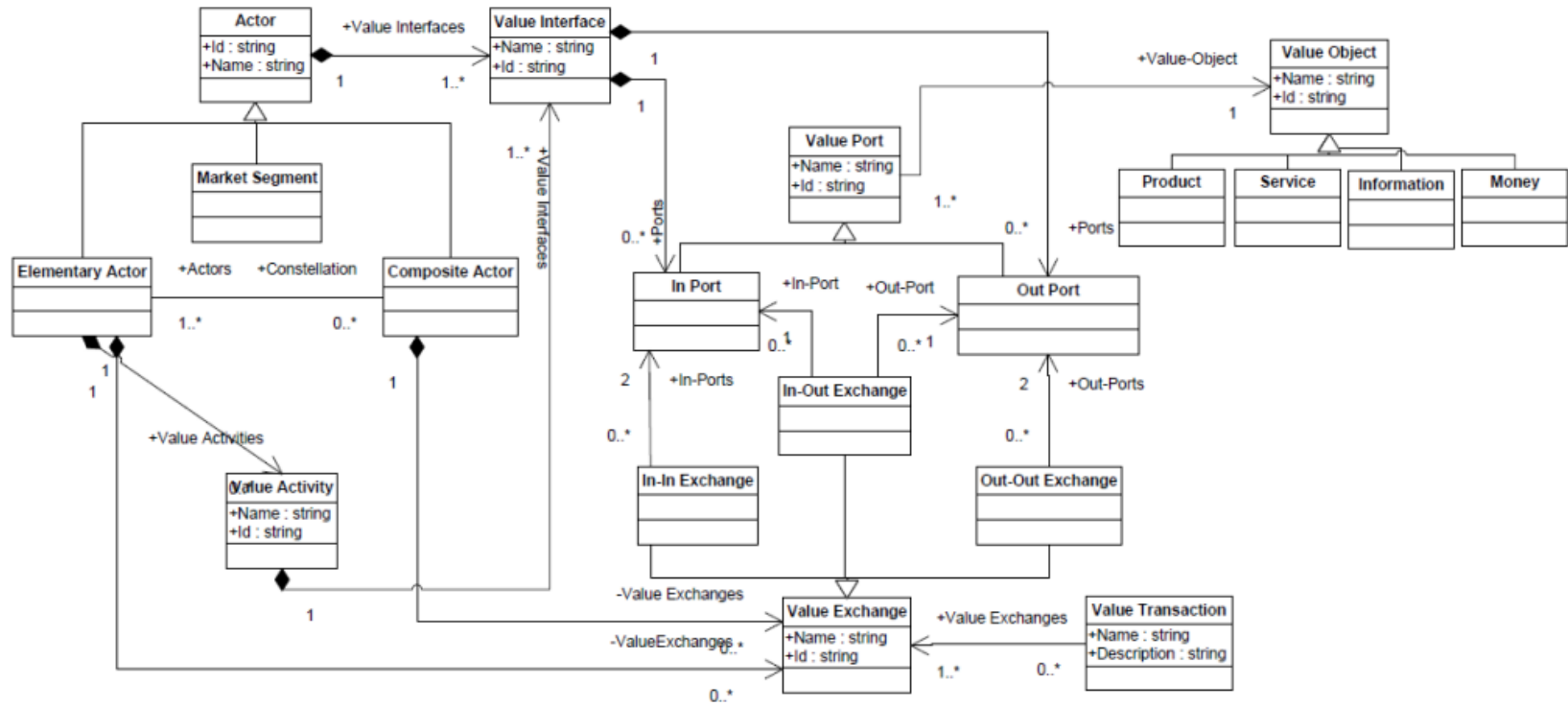

Fig. 60. e3value Metamodel. Source: [330, p. 67].

The storyline of this metamodel would be the following:

1. Actor class is a composition of one or more Value Interfaces. Value Interface is a composition of zero-to-many InPorts and OutPorts, which are child classes of ValuePort class. One-to-many ValuePorts are associated with one ValueObject, a parent class for Product class, Service class, Information class and Money class.
2. Actor class is generalization for ElementaryActor class, MarketSegment class and CompositeActor class. One-to-many ElementaryActor classes are associated with zero-to-many CompositeActor classes. ElementaryActor is a composition of ValueActivity class and zero-to-many ValueExchange classes. CompositeActor is also a composition of zero-to-many ValueExchange classes. ValueActivity class is a composition of one-to-many ValueInterface classes.
3. Zero-to-many ValueTransaction classes are associated with one-to-many ValueExchange classes. Value Exchange class is a generalization for In-InExchange class, Out-OutExchange class and In-OutExchange class. Zero-to-many In-InExchange classes is associated with two InPort classes, zero-to-many In-OutExchange classes are associated with one InPort class and one OutPort class, whilst one-to-many Out-OutExchange classes are associated with one OutPort class.

#### 5.2.14.VDML Concepts Mapping onto e3value Concepts

VDML concepts mapping onto e3value concepts is possible, and the mapping logic is the following: Actor/Collaboration maps onto Actor; Business Network maps onto Composite Actor; Business Network maps onto Constellation; Deliverable Flow maps onto Dependency Element; Community maps onto Market Segment; Scenario maps onto Scenario; Activity Maps onto Value Activity; Business Network Maps onto Value Interface; Business Item maps onto Value Object; Value Proposition maps onto Value Offering; Port maps onto Value Port; Unit of Production maps onto Value Transaction; and Deliverable Flow maps onto Value Transfer [19, p. 107]. Table 34. containing mapping information is displayed in Appendix 3.

The conclusion is that it is possible to map VDML concepts onto e3value concepts.

### 5.2.15.Lindgren’s Business Model Cube

Lindgren ’s Business Model Cube (BMC) has seven dimensions: Value Proposition, Customers and/or User, Value Chain Functions (Internal Part), Competences, Network, Relation, and Value Formula [18, pp. 140-142]. This model is a result of the need for a common business modeling language, and it is a generic framework for any business model [18, p. 135]. The model is depicted on Fig. 61. below:

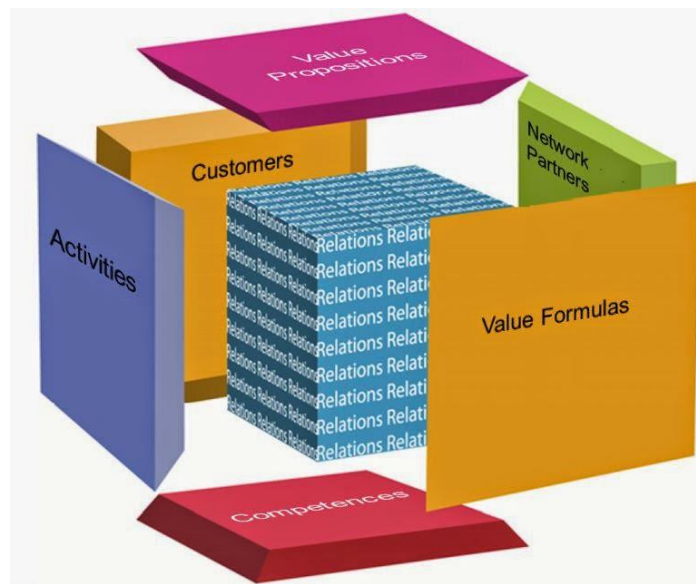

Fig. 61. Lindgren's BMC. Source: [331].

VDML concepts mapping onto BMC Concepts is possible, and the mapping logic is the following: Capabilities maps onto Competencies; Business Network maps onto Network; Deliverable Flows maps onto Relations; Party maps onto User and Customer; Value Stream Maps onto Value Chain; Measure maps onto Value Formula (Profit Formula); and Value Proposition maps onto Value Proposition [19, pp. 109-110].

VDML DIH concepts are mapped onto Lindgren’s BMC concepts, in order to establish weather mapping between VDML and other methods is possible, in this case Lindgren’s Business Model. The results are shown Table 35. in Appendix 3. Mapping is conducted in

accordance with OMG's VDML specification [19, pp. 109-110]. The following section 5.3.16. discusses Lindgren's Business Model Cube Model.

#### 5.2.16. Lindgren's Business Model Cube Model

The storyline of Lindgren's BMC would be the following:

1. As already mentioned, business model cube has seven dimensions: **Value Proposition, Customers and/or User, Value Chain Functions (Internal Part), Competences, Network, Relation, and Value Formula** [18, pp. 140-142], and those dimensions will be drawn as classes in gray color.
2. Value Proposition dimension contains value offered to customers "in the form of products, services and/or process of services and products" [18, p. 140], so **Product, Service**, as well as **ProcessofService** and **Product** classes will be directly associated to ValueProposition class. **Value formula** class defines value proposition. All multiplicities regarding value proposition class are one-to-many.
3. Regarding customers and/or User dimension, it is stated that "business serves customers or/and users" [18, p. 140], so **Customer** and **User** classes will be directly associated to customers and/or User class, with multiplicities one-to-many. Also, value proposition will be directly associated to class Customer and/or User class with multiplicities one-to-many many on both sides (based on the statement in 2 (and [176, p. 140])).
4. ValueChainFunctions (Internal Part) consists of primary functions (inbound logistics, operations, outbound logistics, sales & marketing, servicing) and secondary functions (business model innovation; administration, finance infrastructures; human resource management, procurement) [18, p. 141]. **PrimaryFunction** class and **SecondaryFunction** class will then be directly associated to ValueChainFunctions (Internal Part) class, with multiplicities one-to-many. Then, **InboundLogistics, Operations, OutboundLogistics, Sales&Marketing**, as well as **Servicing** classes will be directly associated to primary function class with multiplicities one-to-many, and **BusinessModelInnovation, Administration, FinanceInfrastructures** with

multiplicity one-to-many; **HumanResourceManagement**, as well as **Procurement** classes will be drawn as child classes to secondary function class.

5. As for the competences dimension, it is important to stress that “The business can choose either to use own competences or network partners competences to carry out the values chain functions” [18, p. 142], so **OwnCompetence** with multiplicity one-to-many and **NetworkPartnersCompetence** with multiplicities zero-to-many classes will be directly associated to competence class. Also, Competence class will be associated to ValueChainFunctions (Internal Part) class with multiplicity one-to-many.
6. Network dimension is based on the notion that “no business is an island” [332, p. 256] but rather in relationship with other business organizations [332, p. 261]. **Business** class will be directly associated to Network class with multiplicity one-to-many.
7. Regarding relation dimension, it is important to stress that “Businesses relate their value proposition, users/customers, value chain functions, competences and network through relations.” [18, p. 142]. **Relation** class will be therefore associated with ValueProposition, Customers/User (directly), ValueChainFunctions (Internal Part), Competences, and Network classes. Also, “Relations can be one to one or one to many.” [18, p. 142], and in this model all associations of relation class will be one-to-many, just to cover all the possibilities.
8. ValueFormula dimension is oriented towards the fact that “any business uses some kind of a formula to calculate the value it offers” [18, p. 142], so **ValueFormula** class will define value proposition class, with multiplicity one-to-many.

Based on this Lindgren’s BMC storyline, model was created and can be seen on Fig. 62. below, based on [18]. Again, Value Proposition class was highlighted as in all the referent architectures’ models previously depicted.

Legend for the Fig. 62. below is therefore the following:

1. gray color - Lindgren’s BMC seven dimensions Operational level elements,
2. blue color – all other elements.



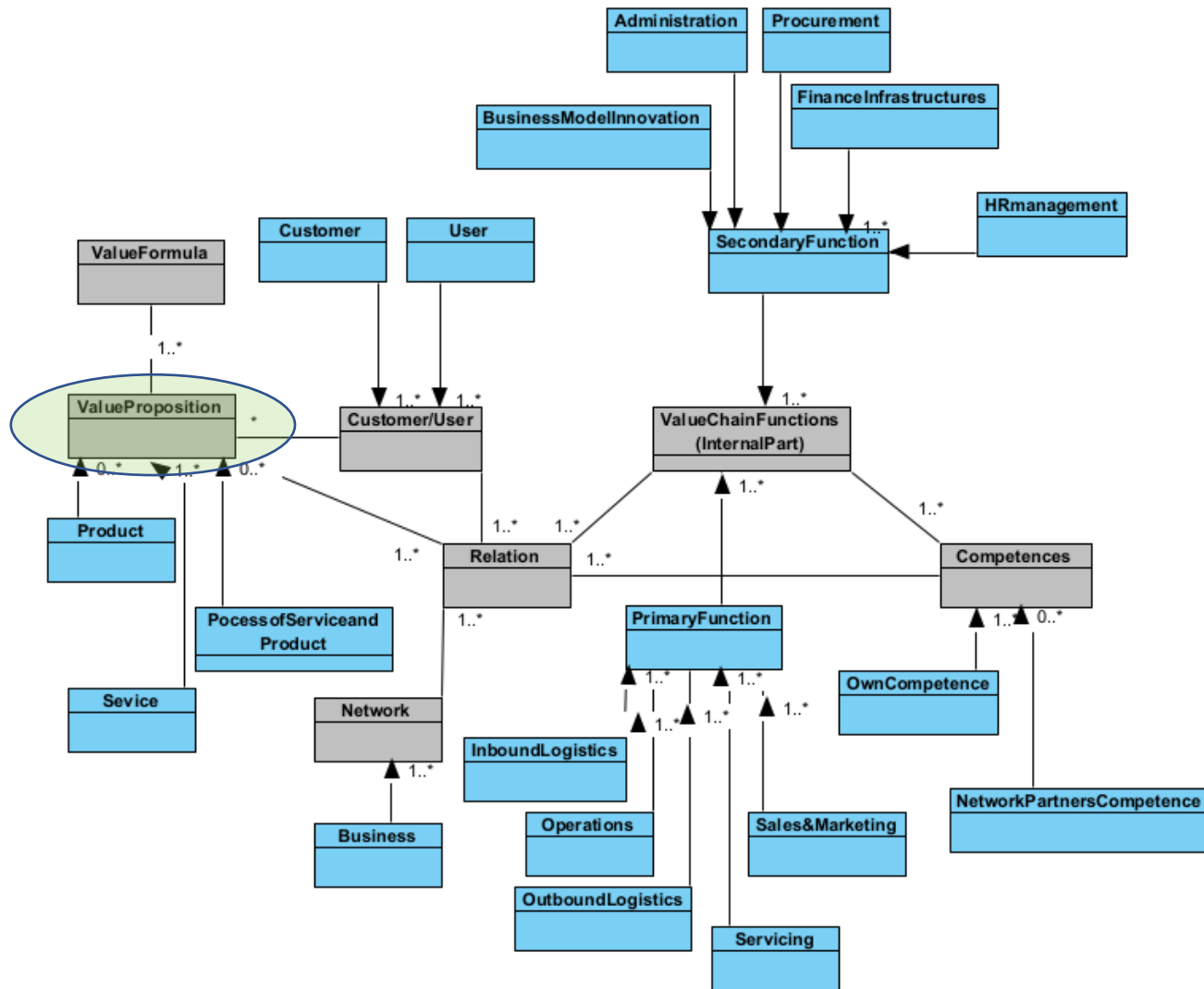

Fig. 62. Lindgren's BMC Model.

### 5.3. Chapter Conclusions

One hypothesis of this thesis claims that in accordance with relevant theories of value delivery, DIH is a VDS. The value needs to be represented adequately, and that can be achieved through modeling, metamodeling, ontologies, different methods, methodologies, languages and tools. Definitions of basic concepts necessary for value representation were given; definitions of modeling, metamodeling and ontologies.

In the domain of VD, this thesis is not dealing with cataloguing its elements, but rather with representing DIH, a part of that domain. For DIH, models and a metamodel will be built, and the closed world assumption will restrict their arbitrary extensions. In that process, artefacts will be specified and RMM will be prescriptive, meaning that it will show what all a DIH has to be composed of in order to be called a DIH. It is also important to stress that specification models in their focus have generation of systems, specification and control [261, p. 258], and that is exactly what DIH RMM will be utilized in future; for the design of DIH information systems. All the above-mentioned arguments go in support of the decision to use metamodeling for DIH RMM design.

It is evident that value can take many different forms in terms of benefits of all sorts for a company or a customer. One of those benefits can also be knowledge. Value in this thesis will be considered knowledge and/or technology which is transferred in support of DT.

Overview of the following value methods and methodologies were given: Value-Driven Development method, e3value method and Systemic Enterprise Architecture Methodology. The following one will discuss value ontologies in more detail. Value ontologies, even though they were not chosen as a method for this thesis, were given some attention as well. Those value ontologies are: REA ontology, OeBTO, AIAI EO, TOVE, BMO, BMC and e-Business Model Ontology. Some other matters which did not fall in any of the previously mentioned categories are mentioned also, and they are: value-based requirements engineering, DVD, i\* 2.0, CVN, e-Value Network Management models, EuGENia tool, Bee-Up, UML and VDML.

DIH's business model was analyzed with VDML. In order to depict DIH model, a tool needed to be chosen. For that purpose, Visual Paradigm tool was considered adequate. M0, M1/1 and M1/2 cognitive level of DIH Model representations were created through concept mapping.

So, VDML concept mapping onto BMC concepts is possible; it is possible to directly map 10 VDML concepts onto BMC concepts and 2 BMC concepts can partially map onto VDML concepts. Two BMC concepts do not map onto any particular VDML concept, but it is possible to inherently find those concepts in DIH literature and only one BMC concept does not map onto anything. Osterwalder's BMC Model enriched with some additional exemplary members relatable to DIH is possible to create, and so is Osterwalder's BMC Metamodel.

Mapping VDML DIH concepts onto VNA can be done. Therefore, it is possible to create a VNA model as well. This chapter gave informational overview of TOGAF Core Content Metamodel and TOGAF Full Content Metamodel, and shows the position of Value Streams in them. Then, five examples of DIH value streams were displayed, which is possible to create following the methodology which describes value streams, creates storyline description, graphically and in table explains stages of a value stream, conducts cross-mapping between necessary business capabilities from capability map and links them to stages in value stream, creates a model of a value stream, and finally creates a DIH Value Stream Metamodel based on those five exemplary models.

VDML DIH concepts is possible to map onto REA ontology, and so is creating REA model and a metamodel. Mapping of VDML DIH concepts onto e3value can also be done; it is possible to create model and metamodel. It is also possible to map VDML concepts onto e3value concepts, BMC Concepts, and so is creation of Lindgren's BMC Model. The final conclusion of this chapter is that mapping between VDML and other referent architectures is possible.

## 6. FOURTH PHASE EXECUTION: VERIFICATION AND VALIDATION

This chapter discusses fourth phase of DSR applied to this research. Fourth phase- Evaluation, consists of two parts; one is verification, and the other is validation. **Qualitative in-depth interview will be conducted**, in order to collect the information from DIH experts. Expert opinion method will be used, since no models exist which could be mapped onto metamodel, making the formal conformance assessment impossible. Based on the gathered results, VDML DIH metamodel will be **verified**; evaluated and adjusted. Also, degree of compliance and incompatibilities of DIH with VDML metamodel will be determined. Afterwards, validation will be conducted through a focus group.

### 6.1. Verification

The three main goals of the interview are:

- (1) Confirmation from practice regarding the suitability of the selected DIH cases from DIH expert literature, which were chosen for DIH RMM design and in-depth interview research,
- (2) Identification of DIH RMM artifacts/elements which are missing or should be removed in order to determine the degree of compliance and incompatibilities of DIH with VDML metamodel,
- (3) Confirmation or adjustment and redefinition of DIH RMM. DIH RMM will then afterwards be validated by a focus group.

Firstly, five interviews were conducted with DIH experts from EC and national authorities. The main goal of this first part of interviewing was to obtain confirmation regarding the suitability of the selected DIH cases from DIH expert literature chosen for DIH RMM design (Appendix 6: List of literature used for preliminary DIH VDML (meta)model representation (and conceptual mapping), the suitability of referent architectures put in DIH context, to verify the initial DIH model and metamodel, and to identify missing, unnecessary or incorrect DIH RMM artifacts/elements, all in order to confirm, adjust or redefine DIH RMM. The interviewees should be able to recognize real world concepts and do mapping between M0 and M1 conceptual levels.

At the very beginning of the interviewing session, interviewees were shown a **list of DIH literature** used for preliminary DIH VDML (meta)model representation and conformance mapping. They were asked whether they find it suitable for DIH RMM design. The list can be seen in Appendix 6. All interviewees found the literature list suitable. Additional pieces of literature were suggested. Information and opinions gathered from the interviewees were carefully read and studied. Then, recognized claims were clustered around relevant concepts pertaining to DIH and placed in the Table 7. below.

Table 7. List of Claims in the First Part of Interviewing Process. Source: Interviewees.

<b>List of Claims</b>	
<b>List of claims pertaining to Activity</b>	
C1	<i>The activities of DIHs are numerous, where the most important one is test before invest. It involves creation of a prototype, and requires laboratory for testing. Trough that activity, companies get know-how and understanding, whilst having to invest their own money if they want to use it for commercial purposes (business).</i>
C2	<i>Training is also a common activity; it not only helps SMEs to use basic IT, but also to know what is supported by Digital Europe Programme. It is the first program for the broad deployment of digital technology, so it is not about implementing state of the art technology but enabling SMEs to use available technology. In that context, DIHs help SMEs with what in Digital Europe Program is available in their area, and examples would be from AI and cyber security to setting up the firewall correctly, etc.</i>
C3	<i>DIHs' activities should include providing expertise and skills on specific advanced digital technology, and also helping companies with finding finances and support for investing in those technologies. DIHs should be members of an active network, in order to have permanent links with other DIHs in region, state and all over Europe.</i>
C4	<i>The activities DIHs perform are also: building competences; consulting; use of equipment and various different services; building line of journey from proof of concept to certification; digital maturity assessment; digitalization strategy development; workshops open to everyone (e.g., blockchain technology); closed workshops tailor made for companies on different thematic; panels; fairs; physical and virtual events; PR and marketing; hackathons; project management; business model development for SMEs (helping them find their market); raising society awareness; matchmaking; meetups; involving students in order to get new ideas from them; matchmaking speedates between students and startups/organizations; facilitation and intermediary-ing between startups, customers and market; teaching workshops: how to build business plan, how to open business facility, how to create strategic intelligence reports, what are the possibilities of funding; use of laboratories from different universities; allowing access to various researchers with competences; the use of supercomputer, digital equipment, and new technology available for commercialization. Some DIHs are also very active in promotional activities through web pages, pamphlets, newsletters, and mouth-to-mouth promotion.</i>
C5	<i>DIHs are always networked entities, in which the most competent entity will do test before invest (in the initial phase, in order to defog a situation). DIH is an assembly of interconnected partners and institutions, so DIHs perform different activities in order to not only help SMEs and Mid-caps in their quest for funds and investors (financial means), but also networking or creation of an ecosystem (different stakeholder</i>

	<i>networks). DIH networks' organizations are contributors to research and technology development, network economic associations, banks, and universities, taking into consideration the DIH scope.</i>
C6	<i>DIH employees perform activities like market analysis, evaluation of new technologies, conducting studies, providing advice on legal issues, as well as venture building (helping start-ups through education and finding access to funds).</i>
<b>List of claims pertaining to Collaboration</b>	
C1	<i>DIHs should collaborate with actors of similar orientation; similar technology or similar market segments. Enterprise Europe Network initiative works with industrialization of companies with similar experiences. Some of the collaborations will be stable/static and have a life span of several years; some DIHs create formal networks for manufacturing and organize events for exchange of the information, which produce subnetworks of the network, where participants are familiar with each other. Other collaborations will be more variable/time-bound; one-to-one, on one-time basis or maybe a period of cca 2 months, and will include only exchange of information, following which participants will go back to their own activities.</i>
C2	<i>One of the main purposes of a DIH is to facilitate development of projects between knowledge institutions/research institutes and companies, in order to develop new knowledge and to transfer mature knowledge to industry. Some DIHs can work as centers which understand the needs of industry, aggregate them and then transfer them to policymaking institutions. For that, DIHs have business intelligence; they target different areas which require further development, so they can serve as business intelligence nodes.</i>
C3	<i>Some interviewees mentioned strategic research partnerships in which DIHs are partners and work together on different topics with many DIHs outside the state. Those would for example be joint projects under Horizon 2020 or Digital Europe Programme, exchanges such as requests for super computer training, organizing digital innovation competitions with other DIHs including participation in international jury, and developing joint services such as codeveloping methodology for AI human resources assessment (willingness of people to accept AI, creating explanations that AI will not replace them in the work place but help them, etc.).</i>
C4	<i>Different orientations of DIHs (for example cyber tech, AI, maritime technology, IoT, etc.) reflect upon their activities and collaborations.</i>
<b>List of claims pertaining to Business Networks</b>	
C1	<i>When it comes to DIHs' business networks, they include collaboration with research and financial institutions, which help SMEs ensure funding. DIHs develop networks between DIHs in different regions and states, and bring knowledge from different regions to their regions, so that they can be a bridge between different knowledge institutions.</i>
C2	<i>The key success factor for DIH business networks is to be dynamic, try to change and involve more partners all the time. An example of a region in SWE was given, where there are few cluster originations working with digitalization, which over the years changed their target groups. At the beginning, they worked mainly with SMEs but then they realized they were good with digitalization and then started working with more mature companies in transforming their digital skills. With time, they changed both the target group and actors they were involved with.</i>
<b>List of claims pertaining to Performance Indicators/Metrics</b>	
C1	<i>Some of DIH performance indicators/metrics are number of experiments/services DIHs provide to customers in a specific period of time, and impact of digitalization on customers, reach to local SMEs and public sector organizations (how many customers</i>

	<i>came asking for help). It is also stressed that DIHs should be proactive and not wait for the customer to come to them, but reach out to customers. The more DIH reaches out, the more they are known in business community. DIH performance is to be evaluated through the number of companies which came for help, as well as the number of experiments in business community for testing new technologies like for instance AI, HPC, cyber security etc.</i>
C2	<i>A survey to beneficiaries of DIH's help is also one of possible metrics.</i>
C3	<i>Some interviewees believe that DIH performance should be measured by how many companies enhanced their business, production, the quality of production etc. In that regard, the metric would be the number of organized workshops and enlargement of production volume.</i>
C4	<i>Other interviewees suggest also measuring satisfaction through online rating of services offered. It would not be necessary that a company uses all of them. Every six months, the list of services would be changed; the ones for which there was no interest would be excluded, and some new ones would be introduced. In that way, it would become apparent which services raise satisfaction of customers, and then it would be decided which services would stay in portfolio. One of the metrics is also services provided count and their impact on the companies.</i>
<b>List of claims pertaining to Value and Value Proposition</b>	
C1	<i>When discussing DIH's value and value proposition, the information gathered shows that the value DIHs bring to SMEs is very different- in some cases it is high technology experiments, giving the possibility of using experimental facilities; in other cases, it is training or daily introduction of basic digital technology.</i>
C2	<i>The main value of the DIH is not technology it is technology for the business. Therefore, value proposition is supporting introduction of technology into business. It does not have to involve high tech, but analyzing the means of the company and supporting the introduction, customization and personalization of existing digital technology.</i>
C3	<i>The European Industrial Strategy is based on green transition and digital transition pillars. DIHs work for Digital transition pillar, and it is a prerequisite for green transition, which encompasses many areas where digital technology is of help. Another value proposition is therefore helping businesses to become greener, and becoming green will soon become mandatory. DIHs should help define right digital technology to address green challenges.</i>
C4	<i>Ideally, DIHs should be VDS but there is always a danger with public funding that they will cater to policy needs and not to business immediate needs. Therefore, there is a danger that some of them will not deliver value. But if DIHs indeed do deliver value, it would be support, development of skills and companies, raising awareness related to digital skills and processes within a company, helping them develop internal processes, digital maturity, services and products, in order to raise digital components in products and services.</i>
C5	<i>Some interviewees argue that DIH's value and value proposition are TT, KT and regional growth, whilst some also mention mutual trust created through networking.</i>
C6	<i>When speaking about KT and TT, there are two sides of DIHs; providing basic knowledge and technology based around digitalization if a mature industry need upgrading but there is also frontier knowledge on AI, so it depends on the purpose of a DIH. Some are more tending to regional development and to broader lifting of more basic digital skills, and the others are more related to high-end skills.</i>
C7	<i>Some other interviewees believe that DIH's value and value proposition is also awareness that a DIH is needed for digitalization, for the improvement of the economy</i>

	<i>through digital technology, work and life in general, in order to create motivation for the DIH model to succeed in real life.</i>
<b>List of claims pertaining to Resources</b>	
C1	<i>Most interviewees agree regarding the most treasured resource for a DIH - competent people (human resources) with different expertise, and who are capable of understanding the needs of their working area, and who are able to transform them into opportunities for digital technology, possess knowledge and know-how of research institutions or specialized companies, and can help SMEs and public administration introduce these digital technologies into day-to-day business.</i>
C2	<i>DIHs must possess two groups of resources: a) skills, b) test beds/equipment; knowledge is very important but also the focus, digital skills but also test beds and test environments with access to hardware.</i>
C3	<i>Some interviewees argue that DIH should be a physical organization with infrastructure. It should also then employ efficient and highly qualified staff specialized in advanced tech, which should provide advice and perform testing of specific advanced technology (not mainstream technology for commercial use). The staff should be able to test how customers would for example use AI or block chain, and show how customers would benefit from that technology. DIHs should have adequate testing and experimentation facilities. It is also important that DIH's skilled staff is connected to other DIHs, in order to reach out for technology in case DIH doesn't possess it.</i>
C4	<i>DIHs have agreements with universities, and also use their employees through outsourcing. Material resources of a DIH are modest; university labs, and solutions through networking with different stakeholders. That makes networking also a kind of a resource. A system for national DIHs to create a network should be proposed, to maximize impact on the economy.</i>
<b>List of claims pertaining to DIHs being non-profit</b>	
C1	<i>DIHs are non-profit one-stop-shops and should therefore not make a profit from their work; the funding they receive should be used to cover their costs. Subcontracting cannot be the core activity of any funded project.</i>
C2	<i>DIHs are not created to produce money; they are organizations coming out of research or competence centers, so the kind of organizations that don't have profitable aim because they are not commercial companies- their mandate is to provide services for public policy, and not for profit. Money which DIH receives is for covering its expenses and providing services to SMEs. So eventually, the funding DIH receives ends up in SMEs. Therefore, DIHs charge a small fee from their customers, or none at all.</i>
C3	<i>DG Connect wanted to emphasize that ends and purposes of a DIH should be more societal. The goal of a DIH should be spreading and developing knowledge. Some interviewees support DIHs making profit; they find it beneficial in the long term because of the necessity for economically self-sustainability, and not only live from the public money indefinitely. Therefore, charging a small fee is acceptable when providing services asked for, and that again comes to the earlier question of catering more to the policy then to the industry the needs.</i>
C4	<i>DIH can contract a business with some other company for some services, and that is then extra income charged from the customer, but only 20% of DIH activities should be commercial, since they are supposed to be non-profit.</i>
C5	<i>Some DIHs' funding is based on company membership, but also on funding from regional development and own funding; it is a mix funding setup. On the other hand, some DIHs come to the point where they need to mix their income, which includes charging a small fee for their services.</i>



C6	<i>Other DIHs charge clients for services and industrial projects, based on the signed contract. "Profit" made is used for DIH employer salaries, travel expense, workshop organization, admin expense, rent, consumables, utilities, and everything that is a standard expense, whilst the rest (if there is any) is reinvested.</i>
C7	<i>For the access to DIH platform some DIHs charge fees to ICT companies (service providers); they have to sign an agreement if they want to join DIH consortium as outside partner, and then can be promoted to the Europe through an EDIH.</i>
<b>List of claims pertaining to quantum computing and quantum communications</b>	
C1	<i>Some interviewees consider that in future, quantum computing and quantum communications will have very little effect on DIHs. No applications for it yet exist, and current EDIHs have a lifespan of 3 years. Quantum communications could be a game changer though, and development of key exchange algorithms for quantum communication is in the planning phase.</i>
C2	<i>Digital Twins concept is based on collecting millions of information pieces from the real world, following which fast calculations are performed through the use of HPC (in future also through quantum computing and quantum communication) in the cloud, and then they act back onto the real world (for example automatic speed control). It is a closed cycle reality- digital/virtual world- reality. Digital twin will replace a human in some other process, and that already started happening. DIHs are also used for that. The Fifth Industrial Revolution brings back a human in focus (satisfaction).</i>
<b>List of claims pertaining to M0 and M1 DIH (meta)model scheme</b>	
C1	<i>One of the remarks was that most DIHs have regional aspects but not all of them. In most cases, DIHs involve interaction with local actors in the region, and also with public actors. One of the proposals was to further elaborate University/Research Establishments as participants in DIH ecosystem; there are many industry associations and innovation entities created to improve innovation capacity in the local ecosystem, which is public but not entirely. Also, there is a significant part of private investment in business of a DIH, and that should also be well reflected on M0 DIH scheme.</i>
C2	<i>It was suggested to change „university“ to „academia“ or „knowledge institution“ because there are different setups in different countries; in SWE for example, it is probably correct, but in DEU it would be research institute sector, in NDL there is TNO-research institute is as important as university.</i>
C3	<i>Some interviewees think that DIH is like a broker-cloud; in the external ecosystem are all the ones that are not direct partners, and in the internal ecosystem are its researchers (experts), ICT service providers, companies as partners in the network (everyone who is a provider). If there exists a partnership agreement with for example business incubator or a chamber of commerce, they are all part of internal ecosystem, but if the partnership agreement does not exist, then those entities are a part of external ecosystem, whether they are a part of someone else's ecosystem or not. Whoever is in the DIH ecosystem is internal. External environment to a DIH are other DIHs all over Europe with their ecosystems.</i>
C4	<i>Some other interviewees think that scientific, technological-developmental and demonstration infrastructure should be included in DIH (meta)model, and that key stakeholders in technologically oriented DIH ecosystems are universities and RTOs (DIHs with societal orientations also exist), so that it is better to include RTO instead of "research establishments".</i>
<b>List of claims pertaining to the list of referent architectures</b>	
C1	<i>Interviewees agreed that DIH RMM will help with providing structure for the DIH catalogue, but it has been emphasized that it should not be too complex and that if a lot of effort is put into very sophisticated model, it will not be too close to reality; the real</i>

	<i>world requires simplicity for functioning. For catalogue, it would be important to include different specializations of DIHs because it would help different DIHs and/or companies find the wanted expertise. It is also important to use phrasing that industry uses, to define what competences and services DIHs have, to make the search for information easier.</i>
--	---

With this, the first part of the interviewing process was concluded. In the second phase, interviews were conducted with different DIH experts. The main goal of this part of interviewing was to identify missing, unnecessary or incorrect DIH RMM artifacts/elements, to establish the degree of compliance and incompatibilities of DIH with VDML metamodel, as well as to confirm, adjust or redefine DIH RMM. Elements previously mentioned subchapter 6.1. were not included in this one, to avoid repetitiveness. Information and opinions gathered from the interviewees were carefully read and studied. Then, recognized claims were clustered around relevant concepts pertaining to DIH and placed in the Table 8. below.

Table 8. List of Claims in the Second Part of Interviewing Process. Source: Interviewees.

<b>List of Claims</b>	
<b>List of claims pertaining to Activity</b>	
C1	<i>Besides the already mentioned DIH <b>activities</b>, some interviewees also mentioned some issues which come along with them. In healthcare for example, the biggest demand and a gap is test before invest, because it is difficult to perform on patients and doctors. For that purpose, sandboxes (“safe environment to play”) have to be created, and then going virtual with data is a must, to create a mini test environment. For a clinical study to be feasible, the product has to be very mature. Those are very high Technology Readiness Levels (TRLs) and DIHs deal with low TRLs. In healthcare, access to finance is also very specific because those projects are high-risk and AI is for them poses a risk. Also, skills and training are very multidisciplinary. Therefore, the basics of digital literacy are needed for a person to become an AI user, and that is not easy to achieve neither with public nor with doctors who are by default not innovators. Also, it is necessary to be able to differentiate between healthcare from wellbeing.</i>
C2	<i>Some DIHs plan to establish their own academy, which will encompass different scientific fields and transfer knowledge tailor made for a specific audience.</i>
C3	<i>Another DIH emphasizes incubation; support to SMEs to become ready to start, finding financing, getting the necessary education and facilities.</i>
C4	<i>Other DIHs mention the following activities: support to SMEs in the area of HPC, TT towards SMEs, educational meetings, advising, using competence center and center of excellence labs (also E-Lab/Smart Lab), virtual telecommunication discussions, developmental activities, providing HPC resources for the computational purposes of SMEs, software and hardware support, and consulting.</i>
C5	<i>Boot camps for the preparation of companies in order to be transformed from “I want to be digitalized” to “I have the basic project for digitalization” and can go through test before invest, is also mentioned by some interviewees.</i>
C6	<i>To be added to the list of activities, according to some interviewees, are also consulting and competence enhancing.</i>

C7	<i>Others mention mingling and familiarization.</i>
C8	<i>Some DIHs, which are not focused on healthcare, also mention the use of sandboxes, which starts with some kind of concierge service. A catalogue of services which follows a business plan is to be created, plans are to be personalized (recognizing strengths and what is crucial), and then they are to be sent to other partners. The catalogue covers the following: concierge, mentoring, finding markets, monetization, providing digital services and robotics, creation of use-cases, providing HPC and infrastructure (servers), business education and connecting with business sector. Following those steps, customers sign a contract.</i>
C9	<i>Public activities of some DIHs are: trainings -reskilling and upskilling of the employees from the industry, events (mostly workshops focusing on access to finance giving all the possibilities to SMEs like grants, voucher or loans), raising awareness about digitalization possibilities of the industry, bootcamps for high school and university students, workshops on what is on the market and what is available to the companies. All that is in some states completely free of charge for customers; for SMEs and maybe midcaps are for free (90% of the participants), and large companies should pay.</i>
C10	<i>Some DIHs mention intelligence planning process which involves consultation and which services can be offered to help the company, customized education with professors, use of many different test beds/kinds of test environments and assistance for using them, industrial workspace, as well as providing assistance during events on which companies are trying to impress investors (venture capital investment), finding appropriate researchers, matching through organizations, finding potential employees amongst graduating and students, whilst not providing direct financial assistance nor legal advice.</i>
C11	<i>Some other DIHs are offering vouchers and services for digitalization, have catalogue of experts, are facilitating processes for funds, organize kick off conferences, design communication strategy, go in media very loudly with PR, are working on the web page, knowledge database, and develop tools to be offered to customers.</i>
C12	<i>One DIH mentioned that besides productivity workshops, seminars, webinars, hackathons, expert widgets to companies, finding different entities which can be interface to reach SMEs, and it used to have TV talk show about digitalization; one season is finished, and now there are discussions regarding continuation.</i>
C13	<i>Some interviewees mention needs assessment and maturity understanding, networking and ecosystem activities such as events and workshops, and connecting customers investing in network activities. They emphasize that their DIH provides support for finding investments in terms of connecting customers with existing investment network, increasing knowledge of customers of available investors, but only assisting them with writing application for outside funding because there are consultants for more detailed services in that area.</i>
C14	<i>Other DIHs create sandboxes for new ideas and testing them, showing how to improve.</i>
C15	<i>Some mention coordinating, communications, piloting, is possibility to do master's thesis for free for a company who needs it at one of partner universities, and very fast prototyping.</i>
C16	<i>Amongst some DIHs activities are: finding contacts to the customers through advertising and communication activities to get in touch with target groups and inform them of value deliverable services offered, then creating customer journey and topics for the customer, systems of customer relationships etc. Those services require planning, thinking about which ones are good for SMEs, then maturity analysis has to be conducted (2-3 hours of questions to go through to get a first impression of SMEs</i>

	<i>too see what are the topics and tailor workshops for them, even though they can book other courses but can go directly to innovation workshops), innovation services, and consulting services, all for which qualified employees are necessary. Smaller companies don't have systematic approach nor personal development; find qualified staff is very important for them, expert networks and self-learning opportunities, as well as networking with other SMEs and experiences exchange in their field of interest. Marketing, communications, sensitizing companies, innovation and qualification topics are also not to be ignored.</i>
C17	<i>Other interviewees mention delivering services for changing business models, before which a survey is conducted regarding the condition of SME- i.e., digital health check, DIGITRANS method is then applied, consulting SMEs follows and then they are handed over to local software companies' cluster.</i>
C18	<i>Some DIHs emphasize that they also take into consideration the supply side of digitalization not only the demand side.</i>
C19	<i>Some interviewees explained that before DIHs appeared, there were akin existing structures in their region for a long time, but DIH provided one-stop-shop to that region and allows talks about digitalization, presentations from universities regarding new technologies, demonstrations of best practices, organization of "entrepreneurs' breakfast" every two weeks for example for the owners of car mechanic shops there who all use software from car industries and share similar experience from everyday life also with functional clusters like procurement managers, and they were shown the newest developments in procurement.</i>
C20	<i>Other DIHs still organize many marketing and awareness raising activities, even though the community had known about them for a very long time up until then.</i>
C21	<i>One interviewee mentioned digitalization of aftersales processes, virtualization of customer experience in car selling point of sales, aftersales services, and virtualization of electric car mechanic garage where they train people in their virtual environments to get skills in repairing electric cars.</i>
<b>List of claims pertaining to Community of Interest</b>	
C1	<i>Some interviewees emphasize educational trainings, which lower barriers and make participating in trainings easier afterwards; all participants are keen to meeting each other again, the activities are more popular than before, and create community of interest.</i>
C2	<i>To be added to the list of activities, according to some interviewees, is mingling and familiarization.</i>
<b>List of claims pertaining to Collaborations</b>	
C1	<i>Besides the collaborations discussed in the first part of interviewing, in this phase some also mentioned that DIHs collaborate with different economy stakeholders.</i>
C2	<i>One interviewee emphasizes the importance of matchmaking; it collaborates in an alliance, through which it creates contacts with the few universities active in that area. Many clients contact those universities themselves, organize meetups, bring investors and make teaching sessions in order to connect.</i>
C3	<i>Some DIHs created groups for the development of companies in certain areas, and collaborate with other states in different areas.</i>
C4	<i>Other DIHs participate in common European projects with partners, which are mainly SMEs.</i>
C5	<i>Collaborations are being established mostly with similar entities.</i>
C6	<i>Some have collaboration with industry cluster, mostly established in state but also elsewhere in Europe, mostly with cluster organizations (predominantly companies,</i>

	<i>research organizations and government organizations) and European Institute of Innovation &amp; Technology (EIT).</i>
C7	<i>Some state that most of their collaborations are regional, with innovation ecosystems focusing on different projects, where members paying a membership fee are welcome.</i>
C8	<i>An interviewee from an entity outside EU also working in the field related to digitalization and different European projects which is officially not (yet) a DIH, participating in Interreg Europe network, using it as a proxy to keep the bilateral connections which will ease the collaboration with EU states.</i>
<b>List of claims pertaining to Business Networks</b>	
C1	<i>When speaking about business networks, in this phase, one of the interviewees mentioned a DIH for CPS, which allowed them to enter their business network gathering partners from every state and creating European CPS network, and application of modern technology in those systems, which they then support through AI and HPC.</i>
<b>List of claims pertaining to DIH Performance Evaluation</b>	
C1	<i>DIHs should raise the level of digital economy, so DIH performance evaluation, according to some DIHs, should include the number of participants at the events they organize.</i>
C2	<i>Other interviewees consider that a DIH has to have the following four necessary indicators: European project (at least one, otherwise it is not a part of KT market), it has to be networked, and it has to collaborate with academia (KT and education) and economy (expertise and TT). These other indicators are desirable, but not necessary: having a project on an internal market (then it uses internal budget- it would be better to use external budget), project which was given to a DIH and a project in which it is a partner as a DIH (as secondary support) and has to be forwarded towards business sector, and finally has to have an impact on academia.</i>
C3	<i>Others mention the number of individuals which will receive education. Thereby, the biggest challenge is to find the optimal balance between the number of indicators, budget, and project evaluation. It is challenging not to create too many indicators, because not achieving their goals will create a problem.</i>
C4	<i>One interviewee emphasized that turnover is a relevant measurement of digital transformation success, not profit itself, and that turnover has the potential for the increase of technical property of the society and the whole region. Emphasis should also be put on embedded projects and reach out.</i>
C5	<i>Some stated that categorizing both customers and services should be done before creating Key Performance Indicators (KPIs).</i>
C6	<i>Others suggest measuring the number of contacts, participants on trainings and events, as well as consultant talks</i>
C7	<i>Some others add improvement of digital maturity of organizations, market maturity and market potential for innovation, number of collaborations with EDIHs and stakeholders (also on EU level), number of businesses of public sector entities, volume of additional investments successfully triggered by the projects, number of persons who received the training, and number of entities which integrated AI in products.</i>
C8	<i>Other interviewees mention the following main benchmarks of the KPIs: the number of successfully trained SMEs, business model trainings, linked constellations between demand and supply SMEs, trained skilled people in different digital disciplines, and services in total they provide to SMEs.</i>
<b>List of claims pertaining to DIH Clients</b>	

C1	<i>A DIH specialized in healthcare stressed that the main clients are not hospitals, but startups creating solutions for the medical sector, not necessarily working for the hospital, they can work directly for the patient.</i>
C2	<i>The clients are mostly SMEs and Mid-caps. Some DIHs mention also startups, people already working in hospitals having ideas and pharma companies with innovating ideas who want to see how to incorporate their ideas in practice (this pertains to DIHs specialized in healthcare), students, entrepreneurs, organizations who want to invest in startups, and universities.</i>
C3	<i>Some other DIHs amongst clients mention younger people with some IT and gaming knowledge whilst majority are just enthusiasts who like gaming (this pertains to a DIH specialized in gaming).</i>
C4	<i>Other DIHs distinguish two customer categories: customer-user (all companies asking for DIH help/expertise, user of the technology which DIH provides) and customer-provider (entities providing technology to DIHs, wanting to present their technology on the market).</i>
C5	<i>Some interviewees stated that the customers can only be legal entities (either private or public, as well as their employees. It is not clear what is the optimal model of organization. 10-20% of customers should be out of state.</i>
C6	<i>Micro companies are not clients to some DIH, whilst others are happy to work with any company regardless of its size.</i>
C7	<i>Some DIHs even match smaller and bigger more experienced companies.</i>
C8	<i>Clients for some DIHs are also regional governments and municipalities (public administration). 80% are SMEs, entrepreneurs, it should be up to 500 employee companies, but most of them will be 20-50 employee companies, producers (manufacturing), industrial producers, and 10% is midcaps (bigger companies), and regional governments.</i>
C9	<i>Another interviewee stated that big companies don't need their services because they have their own innovation labs, but can come to workshops if they want to). Public administration i.e., local cities and communities request consulting for development of regional strategies.</i>
C10	<i>Some state that public administration is a serious customer; online access law for example, where all public administration should be accessible online, and also many processes had to be digitalized (like videoconferencing).</i>

**List of claims pertaining to Value and Value Proposition**

C1	<i>When discussing DIHs value and value proposition, some interviewees again emphasize consulting on how to apply certain technologies in its business, test certain technologies for developing some other digital product or service, provide help in developing emerging and disruptive technologies (EDTs) with some digital innovation or to test of digitalization of some part of process. The next step is to know where the potential suppliers are in order to proceed with public procurement and start implementing that technology -this is the "job" of the DIH; not to develop technologies and transfer them to some other entity but to help with application of existing technologies. So, the value lies in consulting and education (training, competence enhancing, consulting for application). There is some TT if technology is defined as a recipe for how to apply something and have it returned through licensed product, but it is not the focus. They only provide support for customers to start their journey in that direction and go a step further from where they originally were. The value will lie also in strategic partnerships built with important companies, users and public institutions. Even a small improvement with public administration is a huge societal impact.</i>
----	--

C2	<i>Some interviewees emphasize increasing digital maturity of companies, delivering impact on the companies, TT and KT.</i>
C3	<i>Others add to that list also regional growth and making the next step with digitalization in Europe, most of all with AI, through providing help to more traditional and smaller companies which are lagging behind in that regard but have some AI experience, which will hopefully start a domino effect to get the other ones on board. The ones who are not at all looking at AI are not being considered.</i>
C4	<i>Others mention facilitating, as well as skills.</i>
C5	<i>Some DIHs mention demonstration activities with which they will demonstrate some technologies with KT possibilities and raising awareness about DIHs.</i>
C6	<i>Other DIHs emphasize business plans, access towards difficult to reach lobbies and first customers, lobbying towards local governments, and building s benchmark (for example in healthcare, if they pass screening from the national authority, then the process gets easier).</i>
C7	<i>Value and Value Proposition of some DIHs is cooperation with public administration.</i>
C8	<i>Some state that it is not TT, that they have an approach of consulting organization which help someone to apply already developed technology.</i>
C9	<i>Other state that it is DT.</i>
C10	<i>One of the DIHs emphasized that they are applied, because they “came out” of applied university, and when they do science they firstly make a project which someone is willing to pay for and then make a scientific article, which is a flip approach. They do more industrial research, have many mentors with rich business experience, can do a quick triage to see if market can be created for the idea, and can provide infrastructure (but that is not so important because they are service oriented). Knowledge in terms of one-to-one service with experts adjusted to their needs is also the value they offer. They find networking and personalized approach very important.</i>
C11	<i>Some emphasize networking, KT, best practice, access to testing, education, training, access to finance, but not TT.</i>
C12	<i>Others emphasize increasing digital maturity of companies and delivering impact on the companies.</i>
C13	<i>Some find their Value and Value proposition in trying to catalyze DT of companies.</i>
C14	<i>Others verbalize it as optimization from business perspective and trying to help customers from a wider value perspective.</i>
C15	<i>Some interviewees clearly state that their focus is on value delivery, to increase prosperity in general by successful DT, with strong focus on KT.</i>
C16	<i>Others add to the list of the DIH Value and Value Delivery the following: community building services, test before invest services like digitalization pathways, testing and feasibility assessment, smart devices data technology demonstrations and advanced AI services like cyber security, design thinking, design technology solutions, skills development services, knowledge training sessions on the job, advance training course on technology and soft skills, editing adoption, last pillar is support services (financing, funding, scouting for deployment of digital solutions and accelerating and mentoring in digital areas. The reason for that is because they consider them all to be TT and KT services/elements.</i>
C17	<i>According to some, it is business models for start-ups, co-innovation (stakeholders coming from different companies and doing projects from different approaches) and access to city administrations (building tailor made services for them). Also, SMEs need cultural change, so some DIHs set up a program where SMEs can learn how they can work in digital world on a real project; DIHs bring technology and also try to install spirit of how to work i.e., try to present and install a new digital mindset.</i>

<b>List of claims pertaining to Resources</b>	
C1	<i>Besides the already mentioned resources of a DIH, some interviewees mention adequately skilled experts, and most mention equipment and facilities when speaking about resources.</i>
C2	<i>Some DIHs resources are also membership fees (partners who pay yearly amount of money depending on their interest).</i>
C3	<i>Some as a part of resources mention: infrastructure for partners form consortium, where some are owners of test beds and robotic centers on university level; all kinds of expertise coming from experts from the government level policy makers, and business arena; networking trough cluster industry forum); and different financial resources.</i>
C4	<i>Under resources, an interviewee considers all the partners have and that they can use.</i>
C5	<i>Some also mention municipalities, and within those many complementary resources, existing communication channels, different HUBs with their ecosystems, universities in close relations with businesses in region to help with functions of DIH core business.</i>
C6	<i>One interviewee explained that the exact value depends on the project (purpose driven value creation), and in the core is human resources (HR) supporting most of the projects (expert network with knowledge trough experts with different backgrounds)</i>
C7	<i>Some explain that they have their own laboratory testing facilities on their own location, but also university labs and from other entities in the field of AI (corporations/software centers.</i>
C8	<i>Others emphasize the importance facilities and laboratories which a SME can visit and explore how these things work, because it is hard to show the benefits of digitalization only through computers; if you have virtualization opportunities, 3D printing, AI applications, labs with robotics, that makes it much more feasible and understandable to SMEs, and those demonstration possibilities should therefore not be estimated.</i>
C9	<i>Professors are also considered a valuable resource. In this case, they are working in the research institute of the faculty of computer science of university, which is also outsourced (even geographically) as a research center, which is the physical focus of the hub. That allowed the institute to get the money for quite good AI incubator, financed 100% by their district government, which is also a part of their DIH. Through them, the DIH has a good software part, AI incubator for AI spin-offs and start-ups, co-working spaces with different facilities, and all their other research facilities (melting pot of DIH). DIH lacked innovation institution, so they founded it with the money from the state, and brought experienced experts from other regions with a lot of networks to other HUBs.</i>
C10	<i>Other interviewees mention advanced logistics lab, car mechanic of the future lab, digital transformation and creativity labs, business models, AI express, through many institutions coming together in their city, 10-15km apart.</i>
<b>List of claims pertaining to DIHs being non-profit</b>	
C1	<i>Speaking about DIHs being non-profit, in the first interviewing phase was not mentioned that digital maturity assessment creates no real value, according to some interviewees, and will therefore be done free of charge, to keep the customers.</i>
C2	<i>One country has a 3-4 years old digital voucher system; it is a small state aid scheme of up to 10 000 EUR per SME, and it is for SMEs only. There are 4 kinds of digital vouchers: one is for digital marketing, one for cyber security, one for digital competences and one for digital strategy. At the beginning, there was not much demand for those vouchers, but now there is; companies are waiting and a voucher gets taken within an hour and a half time. Ministry of Economic Development and</i>



	<i>Technology opens perspective strings, and each month a particular voucher covering 60% of the expense opens. The voucher system works in the following way: first, a customer SME is chosen, then an expert who will do the service for them, then SME gets approved the project, activities they have to do take place, SME pays to expert who provided support, and then SME demands 60% of payment through the voucher.</i>
C3	<i>Some DIHs offer their services completely free of charge to their customers. Other DIHs try to get some revenues out of services, but just to cover expenses. On the other hand, some DIHs do charge membership fees to some stakeholders, and some are being charged for the services provided, depending on who is the client.</i>
<b>List of claims pertaining to Quantum Computing and Quantum Communications</b>	
C1	<i>When it comes to quantum computing and quantum communications, a DIH specialized in healthcare thinks quantum computing and communications will affect them for sure in future. In bioinformatics, faster calculations will be possible, medical imaging will also benefit, but not every problem in healthcare can be solved with very advanced technology. Healthcare is in most cases lagging behind 10 years, when compared with state-of-the-art technology, even though for medical imaging state of the art technology is being used. For medical technology and pharmaceutical industry, quantum will be a big advantage. Hospitals work in an “old school” manner, and mostly written documents are used. Scandinavian and Asian countries are the most advanced in this aspect. Western world has hundreds of years old hospitals, so their legacy contributes to the reason for legging behind. Virtual hospital is also one of the futuristic concepts, where doctors and patients are at home, monitored from one single point.</i>
C2	<i>Some DIHs believe that quantum is not to become relevant within the next couple of years, and their focus is on what is available now and how can that be used. In that regard, quantum is not in their focus.</i>
C3	<i>Others believe that it is absolutely the next step. The companies have more data challenges than AI challenges. Who could be using quantum in future is the question, but talks are planned in the near future. SMEs have done little with AI, so they will not be the first ones coming for quantum.</i>
C4	<i>Some interviewees mention that quantum is high level topic at the moment, that they have possibilities to organize visits and events for people interested in quantum computing, but at the moment it is a research topic and not practical solutions. It is interesting to think of possible solutions, and see which companies would be interested. Surely, it is a strategic topic and not practical.</i>
C5	<i>There are DIHs that are already dealing with digital twins, issuing training calls for students and workers, and working on different solutions with their partners.</i>
C6	<i>Some claim that crypto would be the customer for quantum, as well as automotive industry (digital twins), and genome industry (corona vaccines). For the regions which are strong in those domains makes sense to have quantum computing.</i>
C7	<i>At the moment, the assumption by some is that new technology will add value; as AI will contribute to digital technology, quantum will open new questions. Will it be under the umbrella of TH or a new chapter, like electrification to digitalization? Will it be a part of DT or a new chapter? The answers to those questions are unknown yet. Quantum will solve certain special types of problems very fast, and act as a service for information systems. Like with AI; image recognition and AI will allow to implement image recognition. With quantum computing, certain types of mathematical problems will be solved in minutes instead of years, and new class of problems will be solvable (special use case). It should be a part of topics in digital arena.</i>

C8	<i>One DIH stated that their partners are looking at quantum from research side, but not from practical side in short or mid-term.</i>
<b>List of claims pertaining to Alignment with S3</b>	
C1	<i>One DIH specialized in healthcare stated that its work is very aligned in its state because it was a requirement from the government to provide initial funding; healthcare was supposed to be one of the crucial domains/clusters- a spearhead booster.</i>
C2	<i>Some DIHs started that they built a project on it, that in their country S3 strategy is updated, and they are one of the co-creators.</i>
C3	<i>Some claim they are completely aligned, some mainly aligned, and some that they are ahead of some of the subchapters.</i>
<b>List of claims pertaining to M0 and MI DIH (meta)model</b>	
C1	<i>Some interviewees believe that professional associations should be included.</i>
<b>List of claims pertaining to other DIH relevant information</b>	
C1	<i>How DIHs come to customers and guide them forward, is about the people who work for DIHs, who in the broader area can help them. Being honest that if a DIH doesn't have a service, customers have to be sent to other DIHs who can help. Working on a "we" is a must, "we" in being fair as a DIH. Also, it is about seeing the services; going to test beds and seeing the latest products and applications. It is easy to make DIHs virtual, but if a customer has not seen the services and if all involved don't work as "we", it will not be a success. There has to be honesty, everyone has to say what they can really offer, open the test beds, be open about the situation and say which test beds they don't have yet.</i>
C2	<i>The reason why DIHs are better or more progressive than the other entities is because they have more focus on the special branch, and the focus is smaller. DIHs are more open to other technologies, sustainability aspects and different technologies, and it is easier to compare/benchmark cross sectoral innovation topics.</i>
C3	<i>Some consider DIHs to involve the next level of networking; joint or common service and common infrastructure is a strong benefit, as well as more resources, more call for cooperation, more guidelines and structure.</i>
C4	<i>Main obstacles for DIHs are finding strategic position in innovation ecosystem. For some, it was difficult to define DIH mission and view of innovation system. There should be a clearer focus and topics for DIHs, but on the practical side. DIHs are new players in the region and have to demonstrate that they are not in competition with other entities. Time is necessary for finding the right place in the ecosystem, and showing how valuable their work is, and that they also have experience.</i>
C5	<i>Amongst DIH problems, some mention attracting and gaining many more SMEs. The case of Bavarian region was mentions as a good practice. Bavaria had a different approach; when the idea of DT appeared, it invested 3bil EUR in DT program in the global area. It had one central institute, which was then integrated into ministerial level, many IT professors in different disciplines were employed, road trips were organized every evening to every region/town in the out-bank, to push the idea of digital transformation even to the smallest company. So, it became a state task. DIHs received 50% of the funding by the companies who have the demand, and that is an interesting model which works well in Bavaria.</i>
C6	<i>In some regions, challenges for DIHs are numerous family-owned fragmented companies which are not used to cooperation (more like competition). It is also challenging to exchange information, and that is why DIHs do maturity test at the beginning and also apply cross learning for the domains which have good solutions (like automotive).</i>

During both phases of interviewing process, a lot of information was gathered about **EDIHs**, which are now inseparable part of the DIH story. Information and opinions gathered from the interviewees were carefully read and studied. Then, recognized claims were clustered around alike concepts pertaining to DIH and placed in the Table 9. below. EDIHs in this thesis will be considered a kind of a DIH, which *de facto* they are.

Table 9. List of Claims Pertaining to EDIHs. Source: Interviewees.

<b>List of Claims</b>	
<b>List of claims pertaining to genesis and comparison of DIHs and EDIHs</b>	
C1	<i>To understand the genesis and comparison between DIHs and EDIHs, it is paramount to understand the beginning of the DIH story. One interviewee explained that some time ago, an analysis was conducted and showed that majority of funding goes to large companies. Post festum analysis of The European Big Data Hackathons organized by EC (Eurostat) showed that Europe is lagging behind in digital services compared to China and USA, and that propagation of money which EU sends to end users is not well distributed. The results of performed study discovered that DIH network in Europe should be created, consisting of some 500 DIHs, and that DIHs have to be knowledge disseminators, entities which will prove that they connect experts and companies. The idea was to get some kind of DIH label for those entities, and that EC should have a way of financing them. Erasmus Horizon Open Calls were launched. Some entities did not know how to apply, and some which were not a part of a bigger group could not apply. EC at some point realized that too many entities of different kinds, some of which were functional and some were not, were registering on S3 Platform, going far beyond the targeted number of 500. Too many entities applied on S3 platform, and EC could not say which ones were DIHs and which were not, and states were too inert to perform adequate selection. EC did not know how to solve that problem, so as a solution, EDIHs were invented. Guidelines were created, the number of EDIHs per state were defined, as well as how much money each EDIH will get per year, but EC wanted states to give a green light regarding whom it will pass forward in pre-selection process, in order to prevent too many applications. EC tried not to have EDIHs of the same orientation geographically to close to one another, and that national economy also has to give one euro for every euro EC gives. DIH and EDIH connection and genesis is just a matter of bureaucratic nature.</i>
C2	<i>By some, EDIHs are more advanced version of DIHs, with much bigger funding opportunities. Some interviewees stated that DIHs are specialized in certain area, that they support EDIHs defined in certain application, and can use certain DIHs within itself; EDIH always has DIHs underneath covering certain areas.</i>
C3	<i>Some other interviewees stated that most EDIHs involve DIHs. Some stated that DIHs are predecessors of EDIHs, and some that EDIHs are a kind of a DIH, not their advanced version; EDIHs' mandate is under EC, and therefore is on a larger scale, receives EC funding and has obligations towards it.</i>
C4	<i>Some EDIHs don't have specific topics on digitalization, they do provide access to knowledge and an ecosystem working together to enable DT. They explain that it is easier to create an ecosystem in a small state but then there are size problems.</i>

C5	<i>In achieving digital maturity, the focus of EDIHs is on SMEs, Mid-Caps and public administration, even though that is not a strict rule. Important EDIH activities are test before invest; testing before the start of production, because an idea can be a great but without an impact on production, and that is why proof of concept is needed.</i>
C6	<i>One interviewee explained that the big challenge is supporting the companies and educating them about the possibilities they have and which can enhance their business, explaining what digitalization is. EDIH should support also those who are far away from digitalization in order not to have a split society, and that is EDIH's main challenge. If customers are educated in an abstract way, it is only a part of the package and just academic work with no real force for the real companies.</i>
C7	<i>One interviewee considers that both DIHs and EDIHs are to be included in the one system, because DIHs are pillars and EDIHs are platforms, lying on the vertical pillars (DIHs). DIHs deal with technology, and EDIHs develop applications with those technologies. The system in which DIHs and EDIHs coexist is necessary because EDIHs would have difficulty existing and functioning on European level without DIHs. 4-5 DIHs and 4-5 EDIHs interconnected vertically and horizontally would make an ecosystem which can propel economy – that is a structured power. DIH cluster systematically connected horizontally and vertically together with professional associations is a force, and a good way towards recovery.</i>
C8	<i>An EDIH also mentioned that the purpose of DIH network should not overlap with EDIH network. The role of DIHs is to give “push”. They also added that in Republic of Croatia, S3 strategies and alignment of DIHs and EDIHs with them requires further refinement.</i>
C9	<i>Some consider that DIHs were testing for EDIHs. Compared to DIHs, EC just built bigger projects and spent more money on this kind of projects (EDIHs).</i>
C10	<i>Some other interviewees stated that EDIH is an experimental EU project, because the budget has to be justified not only through expenses (salaries and bills) but also with delivered services. Each delivered service has to have its own price, and the price of the service has to be formulated in a way that resembles the value given to the customer. That was a challenge. The benefit of an EDIH is that they will enhance the economy in the region, and there is no hard value which they can recognize through that.</i>
C11	<i>Four EDIHs were established in Republic of Croatia; EC quota for the country of that size (like Finland) was two big EDIHs or four smaller EDIHs with the budget provided, and The Ministry of Economy and Sustainable Development of the Republic of Croatia decided on four, in order to satisfy the biggest allowed number of applicants.</i>
<b>List of claims pertaining to composition/organization of EDIHs</b>	
C1	<i>When it comes to the composition/organization of EDIHs, one interviewee stated that in her state, around 10 DIHs created an EDIH- a consortium.</i>
C2	<i>One interviewee stated that through their EDIH, obtaining new equipment will be possible, and they would place it in their incubator, a part of the cluster.</i>
C3	<i>In some states, it is considered prestige of the agency to be the lead partner of the EDIH.</i>
C4	<i>Before becoming EDIH, some entities were not a DIH. They are from the state/region which has many clusters and hubs, which have been collaborating on different projects with other hubs, but EDIHs are a completely new and different entity.</i>
C5	<i>In one state, all EDIHs had DIHs before, and sometimes a couple of DIHs created one EDIH, so they are all interconnected. All those entities created service catalogues in the region.</i>

C6	<i>In some states, there are DIHs which transformed in EDIHs/lead partner of an EDIH (from technical university for example).</i>
C7	<i>One interviewee explained that in their EDIH ecosystem, there are different (mostly technical) participants: universities, Institutes, agencies, companies, centers of Innovation, Chamber of Commerce- 10 partners in total, focused mainly on manufacturing and digitalization.</i>
C8	<i>One EDIH stated that they are a public organization/government agency and are connected in many other organizations like Interreg, Erasmus, other grants and projects around Europe. In some of them they are just a part of consortium, and in few of them they are the lead partner. They prepare a project for a call. They were not a DIH before, but have some connections with local DIHs (have connections with local foundations, have some kind of expectations and then they applied for a call from EC).</i>
C9	<i>One EDIH explained that they are also a consortium of 10 organizations (amongst which 3 cities and 4 universities), where none of those entities was a DIH before.</i>
C10	<i>One EDIH stated that it is a consortium of 7 DIHs (it was Digital Europe Project Tender, and they as consortium applied for a project).</i>
C11	<i>One EDIH is a cluster type organization, an association with membership structure, has been operational for 15 years, and members are mostly technical companies, research organizations, universities, and municipalities). DIHs were initiative that corresponded their values and what they were doing already, so they decided to pursue it and got DIH title. For EDIH, they gathered around a small consortium of partners, other organizations for which they are coordinators. They consider DIH just a title, like ceil of excellence, so anyone can become a DIH if they want, and there are few requirements if you want this status; you have to prove that you are provide digitalization services. It is based on what kind of services you provide to SMEs and name them in context of digitalization. EDIHs have a bigger mandate coming from EC and member states and usually they are composition of partners (various partner are combining their efforts).</i>
C12	<i>One EDIH explained that they are a consortium of 10 organizations, amongst which cities and universities, where none of those entities was a DIH before.</i>
C13	<i>Some EDIHs in their ecosystem amongst associated partners have lot of bigger companies with existing value chains, some of which are hospitals.</i>
C14	<i>EC does not differentiate between regional, national and European EDIHs, and some EDIHs were never DIHs before, they were for example a techno-parks. Some EDIHs cherry pick their partners, in order to maximize synergy effects, and they develop strategic partnerships through EDIH concept.</i>
<b>List of claims pertaining to performance evaluation</b>	
C1	<i>EDIH performance evaluation was also given thought by the EC. EDIHs will receive funding and will be assessed by JRF assessment form before the start, right after the start, and six months after the start of functioning. The most important KPIs will be satisfaction level and trust building issues. Some EDIHs defined a number of digital technologies they want to work on (HTP, AI, cyber security, advanced digital skills, blockchain, IoT, robotics, big data), focusing on 4 sectors (agrifood, manufacturing, tourism, health).</i>
C2	<i>An EDIH, which is a virtual entity, should be focused on one of the key technologies (AI, HPC or cyber security), and has four key sectors of application: production economy, energetics, agriculture, and public administration. EDIHs have KPIs and metrics prescribed by EC.</i>
C3	<i>Others, as s criteria for evaluation mention the number of individuals which will receive education. Thereby, the biggest challenge was finding the optimal balance</i>

	<i>between the number of indicators, budget, and project evaluation; it was challenging not to promise too many indicators to EC, because not achieving goals would create a problem.</i>
C4	<i>Some report that during EDIH formation, there was some creativity in defining the processes and procedures, as well as balancing relationships between indicators; which part of project value will be created through test before invest activities, and how to formulate test before invest. It is clear how to measure KPIs (and will be proven through statements of delivered de minimums vouchers), but what is unknown is how to get there.</i>
C5	<i>Also, before KPIs were given, EC made a detailed analysis of the states' economy, focus areas and what is available there. DTA is a consortium chosen on a public tender conducted by EC, and it supports EDIH network.</i>
C6	<i>Others stated that they set up KPIs in the project and the EC confirmed them, so they have very exact KPIs (for example how many services were used for the SMEs, how many participants on the training etc.), where one of the crucial ones is progress on digital maturity assessment. With all the companies an EDIH is connected, it has to start digital maturity assessment, and then has to do it one year after providing the service, and then two years after. Progress in digitalization can be measured with KPIs like demand of the companies in digital tools after few years, number of participants (companies), different services (in two years it can change because of different services, growth of the economy).</i>
C7	<i>Other EDIHs for measuring efficiency explain that they have different work packages for different customers, and that they are yet to will develop some kind of metrics.</i>
C8	<i>Some DIHs their own Digital Maturity Assessment Tool (DMA Tool), which they consider more in-depth compared to EC's which is more basic.</i>
C9	<i>DTA made a procurement contract, and the coordinator is Spanish company CARSA. CARSA is providing support for EDIH preparation; it is connected to over a hundred regional DIHs, aiding them with business plans, emerging DIH networks' positioning and accessing their opportunities [333]. Web portal will be the most visible CARSA's instrument for online courses, organization of online events and meetings and data sharing, all in accordance with EC's specifications. A few physical events for networking might be organized every year.</i>
<b>List of claims pertaining to international corridors for collaboration</b>	
C1	<i>State support is needed for the agreements to be made (memorandums of understanding); EDIHs have an important component in creation of international corridors for collaboration (for example if an EDIH in one state has competences that EDIH in another stated does not possess).</i>
C2	<i>So far, DIHs did not have funding in some states and did not collaborate with DIHs out of state because they had enough domestic issues. EDIH will do that.</i>
C3	<i>If an ICT company wants to break into market of a certain country, EDIH in domestic country finds EDIH in that country, and communicates with it regarding the proposed matter.</i>
C4	<i>For internal cooperation, one state has a coordinator for EDIHs; a person working for Future Industry Foundation, which is a ministerial agency in charge of improvement of cooperation, and development of guidebook for the standardization of the services given by EDIHs (relations with clients, maintenance of the clients, quality of services and standard for the quality of services- meetings held so far). For external cooperation they still have no guidelines, except writings submitted in the proposals.</i>

C5	<i>EDIHs will create network of more the 150 EDIHs all over Europe in constant collaboration; they will participate in a network on European level and maybe even around the world.</i>
C6	<i>EDIHs will be very active in Europe, and will provide service to every SME, regardless of its location.</i>
C7	<i>EDIH network will be extremely valuable because all EDIHs will participate in it with specific knowledge, from involved universities to engaged and supported companies, and that is the added value. The vice versa approach in which academia learns from practical problems, is a desirable outcome. How that will happen as a side effect, is yet to be seen.</i>
C8	<i>One interviewee emphasized that their every customer will receive services either from EDIH or an EDIH from their network, which can provide them an adequate service. EDIH cooperation should be targeted and focused. EDIH network is a copy of and follows the same logic of European Entrepreneurship Network, which focused on establishing a long cross-border cooperation, whilst EDIHs the main focus is support to digitalization.</i>
C9	<i>One EDIH explained that they are planning collaborations with other EDIHs, but mainly those who can bring value to them.</i>
C10	<i>An EDIH stated that their collaborations are with EDIHs in other countries.</i>
C11	<i>EDIHs could be a success model which will work in every region. There are many HUBs but there is no proof of what works in every region.</i>
<b>List of claims pertaining to funding</b>	
C1	<i>There are EDIHs with the contract with EU, and some extra EDIHs are entirely funded by the governments; if a state has money, it can have more EDIHs. Each state can choose which package for the financing they will use; some of them cover it with their government money and some try to find it on European level. Many governments choose to cover expenses with the means from Recovery and Resilience Plan, so it is again European money just from different stream. So, for EDIHs in some states, 50% of the money comes from EC, and 50% from the government, and some EDIHs receive complete funding from Recovery and Resilience Plan.</i>
C2	<i>On the other hand, some EDIHs receive 50% of the funding through EC, 20% from partners and associate partners (through annual fee paid for participation in the program), and 30% from the government.</i>
C3	<i>Other EDIHs are funded by EC, ministry, associate partners paying fees to be included (for example big companies, hospitals), municipality funds, and own money.</i>
C4	<i>Some DIHs/EDIHs are building a model which will make them commercially viable in 6-7 years. Right now, they are doing the testing to see which services they are really good at and which companies are going to be willing to pay for the services they receive.</i>
C5	<i>In some states, in couple of years, there should be professional funding also for DIH services, and public funding should be put in the background, so services in future should cost something.</i>
C6	<i>One EDIH emphasized that the fact that all EDIH activities have to be free of charge, is challenging for commercial companies; it requires the change of perspective, where their services don't have to be free of charge for the customers. 50% of funding goes through EC, and some states will require their customers to pay something in order to cover the remaining 50%. The interviewees estimated that in Republic of Croatia, the requirement to cover the remaining 50% by charging fees to customers would never pass.</i>

C7	<i>Some states plan to cover the other 50% needed for EDIHs through National Recovery and Resilience Plan or Operational Programme Competitiveness and Cohesion.</i>
C8	<i>Other EDIHs have a more complex financing model; 50% comes from EC, other companies 10% (annual fee from partners, which then have some special rights, i.e., they receive some services free of charge), 30% from the ministry, and the remaining 10% is covered by their municipalities' innovation fund.</i>
C9	<i>Others, besides the 50% of funding through EC, have 20% coming from partners and associate partners (price per year for being in program), and receive 30% from their government.</i>
C10	<i>Some EDIHs for now have only 50% money promised and will not get before April/May 2023, maybe June/July 2023, so they have to be careful to whom to deliver and which services they deliver in this first part of the year of the EDIH project, because some costs might not qualify; specific description of priorities were not prescribed and monitoring committee has not been appointed yet.</i>
C11	<i>An EDIH, which is a consortium of DIHs and which also used to be a DIH before, stated that problem with their DIHs is that customers used to getting all the services for free and now they have problems with companies having to pay when they turn to EDIH for a service. For vouchers, which they get in its state, they still get 60% coverage of their expenses. It is clear which services are provided by DIH and which by EDIH.</i>
C12	<i>Another EDIH has 50% expenses covered by EC, remaining 50% covered by separate government project (national support project for EDIHs with separate regulation-Resilience and recovery fund RRF). They are fully covered, but "the devil is in the detail"- RRFs don't cover Value Added Tax (VAT) costs; when they are purchasing goods or services, they can recover full cost from Europe but only partly from national part, for salaries and travel there is no VAT and they are covered. So, they will have double accounting one for EC and other for the state, while Digital Europe and EDIH program VAT is applicable.</i>
C13	<i>In one state, all EDIHs are supported by 50% funding from EC, and other 50% from European Funds for Modern Economy 2021-2027, where only existing EDIHs will be allowed participation in that call.</i>
C14	<i>One interviewee stated that it is not easy to operate EDIH without a fixed financial income; if there is coverage for the remaining 50% of needed funding, it is a problem.</i>
C15	<i>Some DIHs consider becoming an EDIH is of no extra benefit, because they consider EU a very bureaucratic organization and to access funds is a lot of work (a job besides a job), and it requires many people to manage this access to EU funds. These DIHs have partners (local cities, hospitals, companies etc.) which provide budgets and sometimes there are also regional possibilities for funding. For them, public and private companies/organizations and startups for which they work for free are the main sources of funding. They have their own small investment funds to invest in startups, they don't make money, and if they do, it goes back to DIH work; back to startups, marketing purposes, event-based purposes etc.</i>
<b>List of claims pertaining to Customers</b>	
C1	<i>EDIH customers are mainly SMEs. EDIHs provide services to public admin also.</i>
<b>List of claims pertaining to quantum computing and quantum communications</b>	
C1	<i>Some interviewees believe that quantum computing and communications will not have a big impact on them. They are working with simpler objectives, and quantum is not in the picture yet. As an EDIH, they are not supporting big science; this is objective for other programs.</i>



C2	<i>One interviewee stated that quantum was mentioned, but was not considered of key importance for the EDIH.</i>
C3	<i>Others explain that quantum is more on university level of discussion, and that it is not to become relevant within the next couple of years. EDIH focus is on what is available now and how can that be used in practice.</i>
<b>List of claims pertaining to S3 alignment</b>	
C1	<i>A largen number of interviewees stated that their EDIHs are aligned mostly or completely with their s3 strategies.</i>
<b>List of claims pertaining to starting date</b>	
C1	<i>The first EDIHs were created in 2022. Some will start functioning on 1 Jan 2023. In three years (2025/2026), there will be another call for completing the EDIH network.</i>
C2	<i>Some EDIHs started functioning at the beginning of Oct 2022, but started trying to find the funding years ago. Other EDIHs are functional since 1 September 2022.</i>

Interviews were conducted between 18<sup>th</sup> August 2022 and 17<sup>th</sup> January 2023. Following the interviews, and also as a part of the verification, some practical examples were used- DIH Catalogue and examples of some other entities, for which DIH RMM could also be used.

There are six DIH Catalogue predefined fields (attributes of a DIH) which will be explained: Countries, Evolutionary Stage, Technologies, Services Provided, Focus on TRL and Sectors [105]. In order to verify weather DIH RMM covers the attributes predefined in EC's DIH Catalogue, the DIH RMM concept that covers them should be identified. EC's DIH Catalogue Tool can be seen on Fig. 63. below.

## Digital Innovation Hubs

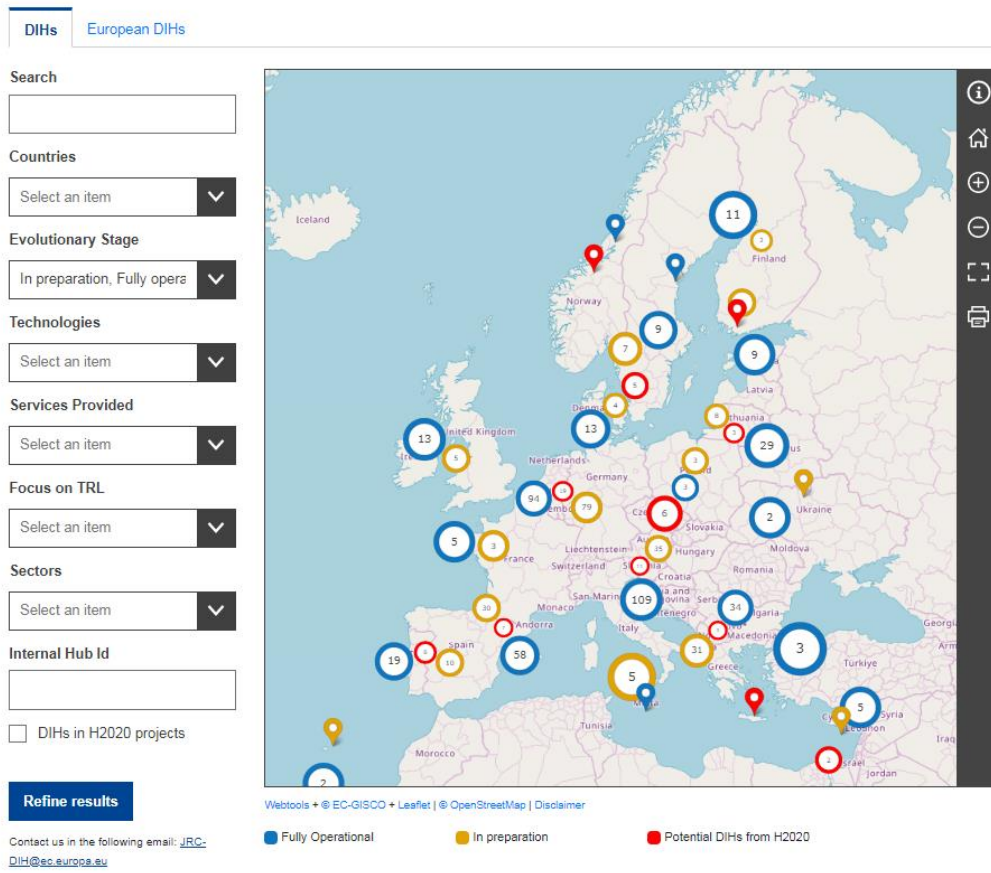

Fig. 63. DIH Catalogue. Source: <https://s3platform.jrc.ec.europa.eu/digital-innovation-hubs-tool> [118].

Below DIH Catalogue Tool, there is a DIH Contact List with all the registered DIH. The preview of DIH Contact List can be seen on Fig. 64. below.

⚙️ Click on the following link if you want to propose new HUB.

📄 Export contact list to excel

Hub Name	Location	Contact	Phone	Email	Website
<a href="#">3D Makers Zone</a>	Oudeweg 91-95, 2031 CC, Haarlem	Maarten Verkoren	31655190110		
<a href="#">3IF - Industrial Internet In Flanders</a>	Weldadigheidsstraat 14, 3000, Leuven	Seldeslachts Ulrich	+3216328541		
<a href="#">3IF.be &amp; 3IF.be Fieldlab</a>	Kasteelpark 10, 3001, Heverlee	Seldeslachts Ulrich	+3216328541		
<a href="#">4PDIH - Public Private People Partnership Digital Innovation Hub</a>	Tržaška 25, 1000, Ljubljana	Emilija Stojmenova Duh	00386 1 4768 145		
<a href="#">5G Fieldlab 5Groningen</a>	Zernikelaan 17, 9747 AA, GRONINGEN	Peter Rake	+31653698984		
<a href="#">5G Test Network Finland (5GTNE)</a>	Kaitoväylä 1, 90571, Oulu	Kyösti Rautiola	+358400582246		
<a href="#">5GBarcelona</a>	c/ Gran Capità 2-4 Edifici Nexus I 2ª planta 203, 8034, Barcelona	Dr. Sergi Figuerola	+34675780950		
<a href="#">5TONIC Open 5G Lab 5TONIC</a>	Avenida del Mar Mediterráneo 22, 28918, Leganes, Madrid	Arturo Azcorra	+34 91 481 62 10		
<a href="#">7TB - 7 Technopoles de Bretagne</a>	2 rue François Briant de Laubrière, 29000, QUIMPER	Arnaud RENTENIER	0297120658		
<a href="#">Aachen DIH Center for Robotics in Healthcare</a>	Pauwelsstraße 30, 52074, Aachen	Univ.-Prof. Dr. med. Rolf Rossaint			

① 2 3 4 5 6 Next >

Total number of elements: 719

Fig. 64. DIH Contact List. Source: <https://s3platform.jrc.ec.europa.eu/digital-innovation-hubs-tool> [118].

Trough clicking on any of the available DIHs' names, DIH Profile page opens with twelve predefined fields (attributes of a DIH): Location, Hub Information, Description, Contact Data, Organization, Technologies, Link to national or regional initiatives for digitizing industry, Market and Services, Service Examples, Funding, Customers and Partners [334], example of which can be seen on Fig. 65. below.

## Digital Innovation Hubs

### < DIH Profile

#### PAGE CONTENTS

- Location
- Hub Information
- Description
- Contact Data
- Organisation
- Technologies
- Link to national or regional initiatives for digitising industry
- Market and Services
- Service Examples
- Funding
- Customers
- Partners

### 3D Makers Zone

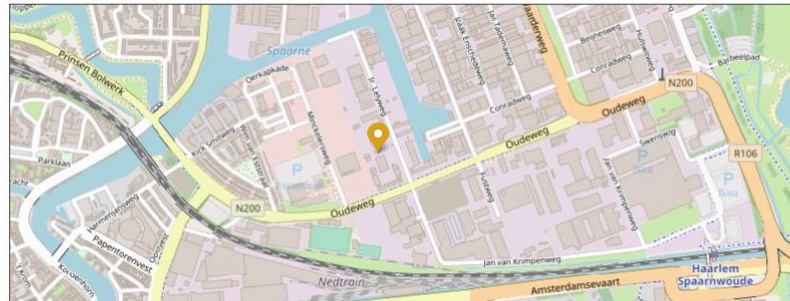

Webtools + © EC-GISCO + Leaflet | © OpenStreetMap | Disclaimer

#### Hub Information

Hub Name	3D Makers Zone
Local Name	3D Makers Zone
Evolutionary Stage	In preparation
Geographical Scope	Regional

Fig. 65. DIH Profile Page. Source: [https://s3platform.jrc.ec.europa.eu/digital-innovation-hubs-tool/-/dih/1152/view?\\_eu\\_europa\\_ec\\_jrc\\_dih\\_web\\_DihWebPortlet\\_backUrl=%2Fdigital-innovation-hubs-tool](https://s3platform.jrc.ec.europa.eu/digital-innovation-hubs-tool/-/dih/1152/view?_eu_europa_ec_jrc_dih_web_DihWebPortlet_backUrl=%2Fdigital-innovation-hubs-tool) [334].

All these predefined fields (attributes) should have their place reserved in DIH RMM concepts (M1/2 Cognitive Level which sums up all M1/1 DIH Models' Representation). Those concepts of DIH RMM are circled and can be seen on Fig. 66. DIH RMM Concepts Covering DIH Catalogue Elements (Attributes). Source: Authors own conclusion and Fig. 66. below. Firstly, six DIH Catalogue predefined fields (attributes of a DIH) will be explained. Attributes Countries, Evolutionary Stage, Focus on TRL and Sectors belong to **Attributes** metaclass; whilst Technologies and Services Provided will be covered by **Capability** and **CapabilityLibrary** metaclasses. Those concepts of DIH RMM are circled and can be seen on Fig. 67. below. Then twelve predefined fields (attributes of a DIH) on DIH Profile page will be explained. Attributes Location, Hub Information, Description, Contact Data and Organisation should be covered by **Attributes** metaclass; attributes Technologies, Service Examples as well as Market and Services should be covered by **Capability** and **CapabilityLibrary** metaclasses; attribute Link to national or regional initiatives for digitizing industry should be covered by **Party** metaclass; attribute Funding should be covered by **Participant** metaclass; and attributes Customers and Partners should be covered by **Participant** and/or **Actor** metaclass.



Besides already mentioned ones, some other DIH and DIH RMM concepts can be concluded upon from information provided on DIH Profile page. Under Description section of the page, some organizations are listed whose digital transformation was supported by this DIH; those were **Clients**/customers of a DIH and belong to **Actor** and **Participant** DIH RMM metaclasses [334]. That is displayed on Fig. 67. below.

PAGE CONTENTS

- Location
- Hub Information
- Description
- Contact Data
- Organisation
- Technologies
- Link to national or regional initiatives for digitising industry
- Market and Services
- Service Examples
- Funding
- Partners
- H2020 Projects

### Description

3IF.eu is the Belgian Industrial Internet, Industrial IoT and Industrie 4.0 knowledge and expert centre.

3IF.eu provides knowledge and experience sharing, use cases and advisory services for digital transformation for Manufacturing companies, mainly in Flanders. 3IF is aligned with and supports the smart specialisation strategies according to the S3 priorities in Flanders (<http://s3platform.jrc.ec.europa.eu/regions/BE2/tags/BE2>) of specialised manufacturing solutions, innovative work organization and smart systems.

3IF.eu supports the development of technology companies active in Industrial IoT, Analytics, Cloud services and supporting service

3IF.eu is the Industrie 4.0 innovation hub in Belgium and Flanders, connecting to SmartIndustry Netherlands, Industrie 4.0 in Germany, Industrial Internet Consortium and AIOTI.

**3IF.eu operates multiple fieldlabs on Condition Based and Predictive Maintenance and Industrial Data Space.**

3IF.eu is a non-profit initiative, part of the non profit organization Isec.eu, with a physical presence in Belgium - Leuven - Heverlee and Brussels. Details of our activities can be found at <http://www.3if.be>

3IF.eu has supported digital transformation of many organizations, including :  
 Reynaers Aluminium ([www.reynaers.be](http://www.reynaers.be)), Citrique Belge ([www.citriquebelge.be](http://www.citriquebelge.be)), Tenneco Belgium ([www.tenneco.com](http://www.tenneco.com)).

### Contact Data

Fig. 67. Clients/customers of a DIH Listed on DIH Profile Page. Source: [334].

On the same DIH Profile page, under 2020 Projects section of the page, some projects are listed; those are **Business Networks** in which that DIH is a **Party**, belonging to BusinessNetwork and Party metaclasses on DIH RMM respectively. Those Business Networks also represent **Collaborations** in which this DIH is a **Participant**. That is displayed on Fig. 68. below.

## H2020 Projects

- TRINITY

Digital Technologies, Advanced Robotics and increased Cyber-security for Agile Production in Future European Manufacturing Ecosystems

- DIH-World

DIH-World - Accelerating deployment and matureness of DIHs for the benefit of Digitisation of European SMEs

- PhotonHub Europe

One-Stop-Shop Open Access to Photonics Innovation Support for a Digital Europe

Fig. 68. Business Networks (Collaborations) of a DIH listed on DIH Profile Page. Source: [334].

Another instance where DIH RMM concept could be used are European Institutes of Knowledge and Technology (EIT) HUBs; in 2014., was launched in order to enhance innovation performance in countries whose innovation scores are moderate or modest according to European Innovation Scoreboard [335]. As a part of EIT Global Outreach Programme, the footprint is expanded worldwide towards various different innovation hot spots and connecting knowledge, talents and key players throughout the world, to contribute to quest for solutions addressing societal challenges [336]. The same source further states that under Global Outreach Programme there are two EIT Hubs; one is located in Tel Aviv, Israel, and the other one is in Silicon Valley, USA [336].

EIT HUB ISRAEL has its concepts presented on the WEB page. From the presented concepts, it is possible to recognize concepts of DIH RMM. Value and Value Proposition (belonging to **Value and Value Proposition** DIH RMM metaclass) are clearly stated on EIT HUB ISRAEL web page and it can be seen on Fig. 71.. and Fig. 70. below.

# BUILDING BRIDGES: EU AND ISRAEL

Israel, also known as the “Startup Nation”, is a world leader in tech innovation with ~7000 startups, translating into an impressive 1 innovative company for every 1,400 people. As an innovation hotspot, Israel became one of the European Institute of Innovation and Technology’s (EIT) global outreach locations.

EIT Hub Israel was established in 2019 with the mission to nurture and create synergies with the Israeli innovation ecosystem and support the growth of innovative EU and Israeli start ups. We do this through our innovative programmes and extensive global network that leverage both economies and empower entrepreneurs and corporates alike to make a societal impact.

Whether you are an industry leader, a governmental body, an academic institution or an ecosystem player, EIT Hub Israel offers you the chance to gain access to the leading innovative opportunities and expand your global network.

## PROGRAMMES

EIT Hub Israel offers industry, academia, government and ecosystem players the chance to join or programmes and gain knowledge exchange, best practices and innovative opportunities.

Fig. 69. EIT HUB ISRAEL Statement of Value and Value Proposition. Source: <https://go-eit.eu/eit-israel-hub/> [337].

## OUR COMMUNITY'S ADDED VALUES

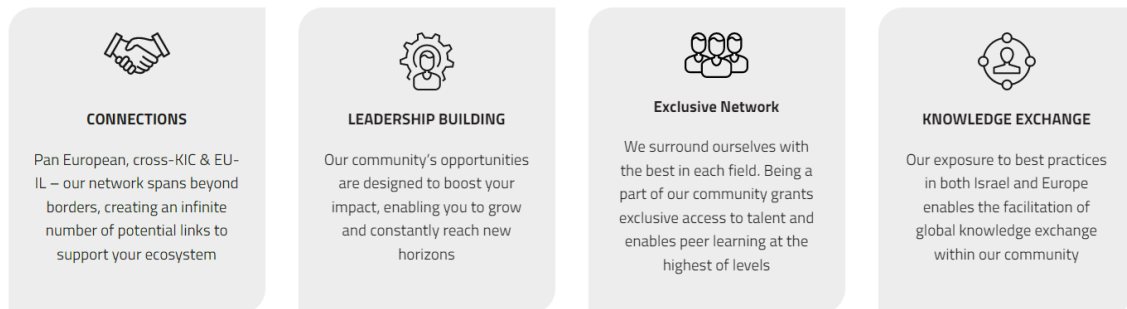

Fig. 70. EIT HUB ISRAEL Another Statement of Value and Value Proposition. Source: <https://go-eit.eu/eit-israel-hub/our-community/#our-community> [338].

The same web page also gives insight of different programs EIT HUB ISRAEL covers. Those can be considered **Activities** and can be seen on Fig. 71. below.



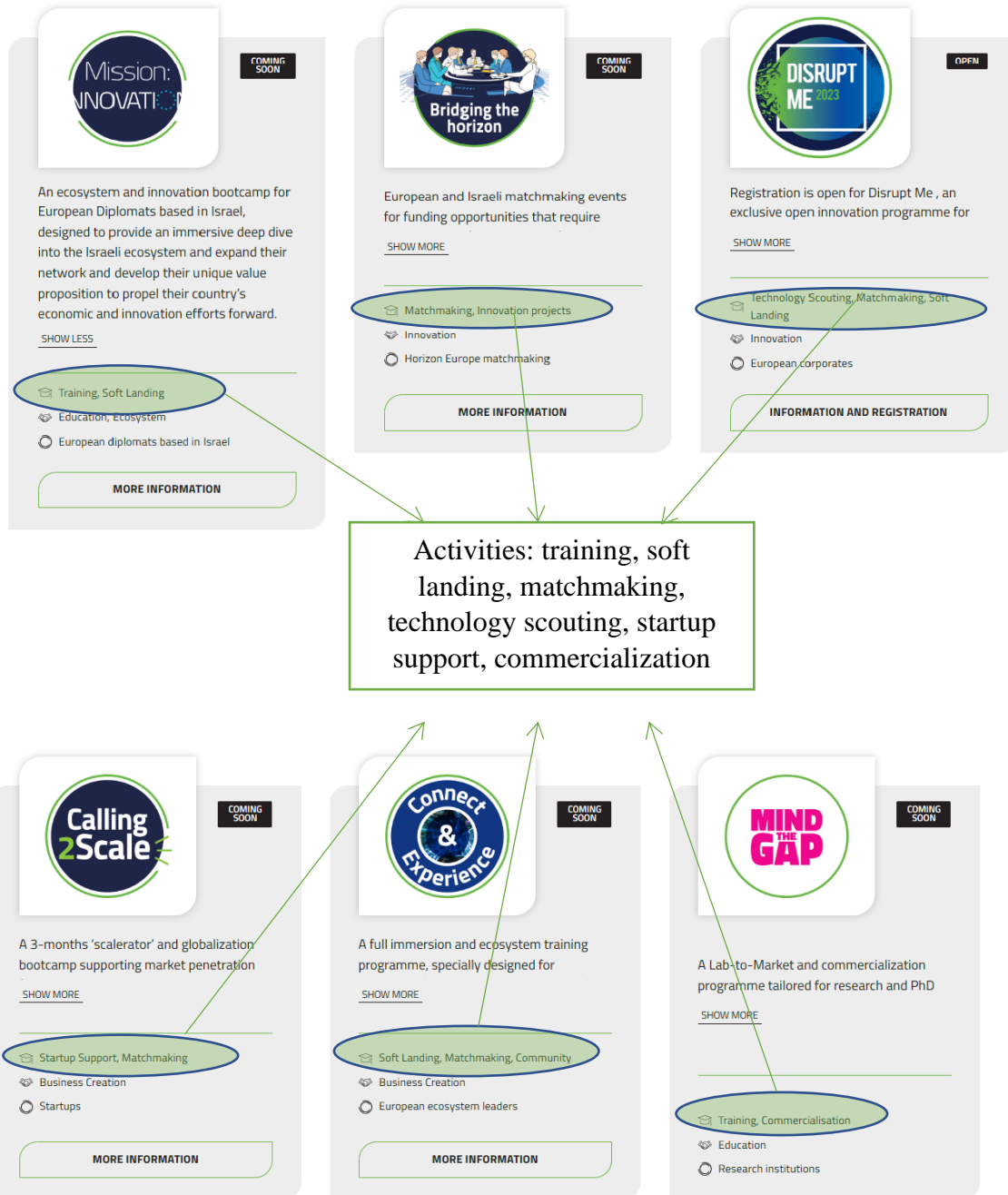

Fig. 71. EIT HUB Israel Activities. Source: <https://go-eit.eu/eit-israel-hub/> [337].

Another thing that the HUB's website shows are its six Knowledge Innovation Communities (KICs), which in fact are **Communities of Interest**: EIT HEALTH, EIT FOOD, EIT URBAN MOBILITY, EIT CLIMATE-KIC, EIT MANUFACTURING AND EIT DIGITAL communities of interest [337]. Those Communities of Interest can be seen on Fig. 72. below.

## KNOWLEDGE INNOVATION COMMUNITIES (KICS) INVOLVED

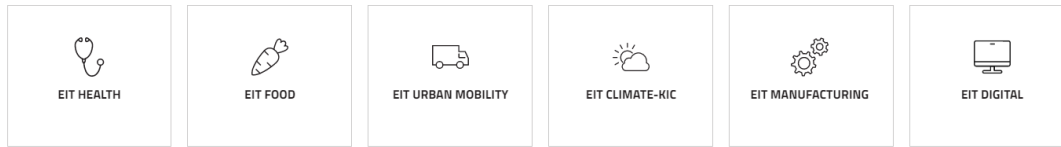

Fig. 72. EIT BHUB ISRAEL Communities of Interest. Source: <https://go-eit.eu/eit-israel-hub/> [337].

Also, the HUB organizes many **Events** [339], which can be seen on Fig. 73. below.

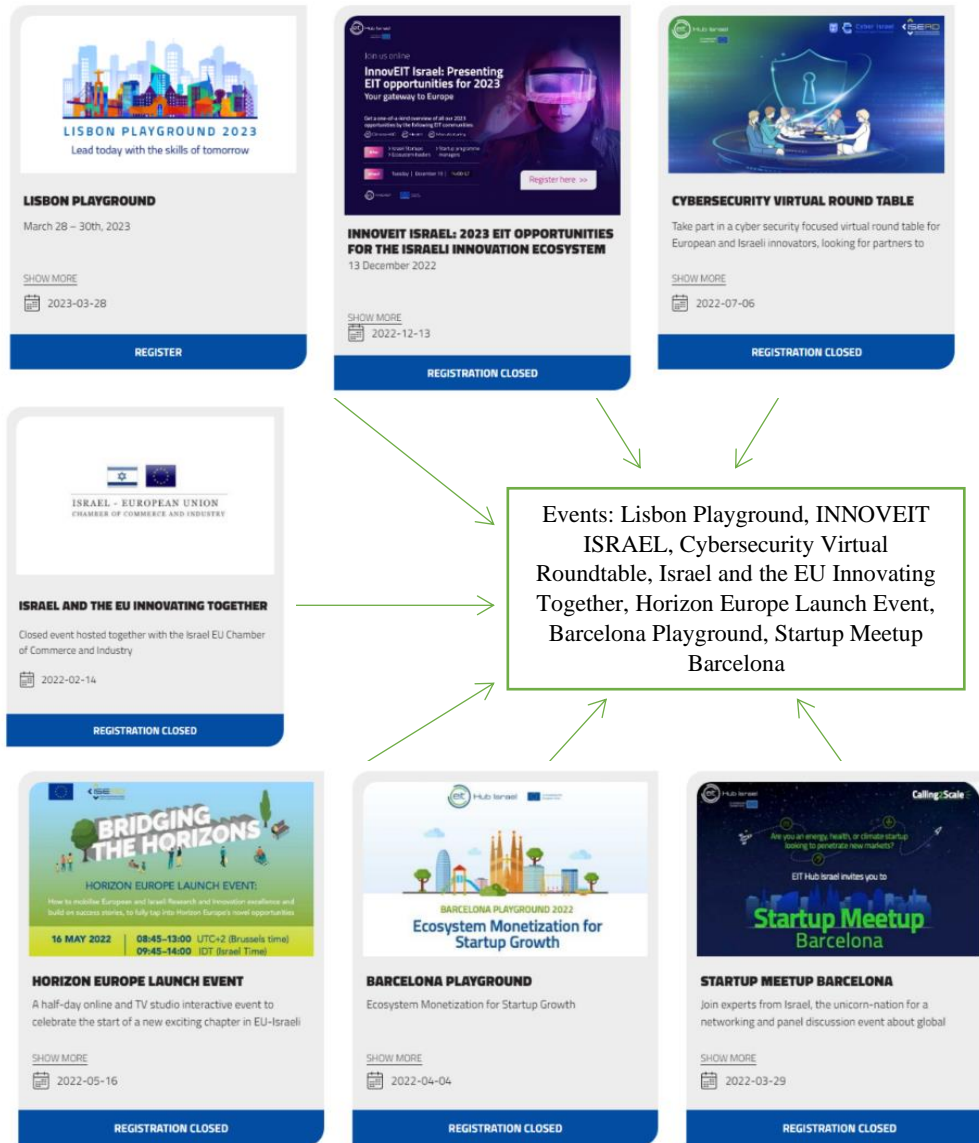

Fig. 73. EIT HUB ISRAEL Events. Source: <https://go-eit.eu/eit-israel-hub/our-programmes/#events> [339].

EIT HUB ISRAEL **Community** is also described on the HUB's web page; it is composed of research centers, academic organizations, government bodies, industry, hospitals, municipalities, different EIT hubs, startups, entrepreneurs, mentors, diplomats, venture capitalists, KIC members, and talented individuals (<https://go-eit.eu/eit-israel-hub/our-community/#our-community>).

EIT HUB SYLICON VALLEY established in 2019, was the first EIT HUB out of Europe, in order to support European innovators with showcasing their innovation to innovation and education ecosystem of California i.e., US customers, investors and partners (<https://go-eit.eu/eit-silicon-valley-hub/>).

The HUB's website displays the HUB's **Collaboration** called Transatlantic Innovation Platform, whose purpose is projects undertaking between California and Europe in the field of climate change, as can be seen on Fig. 74. below <https://go-eit.eu/eit-silicon-valley-hub/our-programmes/#programmes>.

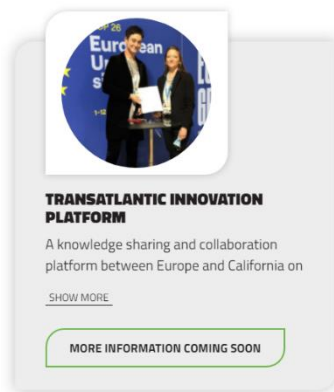

Fig. 74. EIT HUB SYLICON VALLEY Collaboration. Source: <https://go-eit.eu/eit-silicon-valley-hub/our-programmes/#events> [340].

HUB's website shows its six KICs i.e., **Communities of Interest**: EIT DIGITAL, EIT CLIMATE-KIC, EIT URBAN MOBILITY, EIT RAWMATERIALS, EIT FOOD, and EIT MANUFACTURING communities of interest [341]. So, the difference between EIT HUB

ISRAEL's and EIT HUB SYLICON VALLEY's Communities of Interest is that the first one participates in EIT HEALTH, and the latter one in EIT RAWMATERIALS, whilst the others are the same. Those Communities of Interest can be seen on Fig. 75. below.

The website also lists six HUB's partners, which vary from state bodies to different business associations [341].

### KNOWLEDGE INNOVATION COMMUNITIES (KICS) INVOLVED

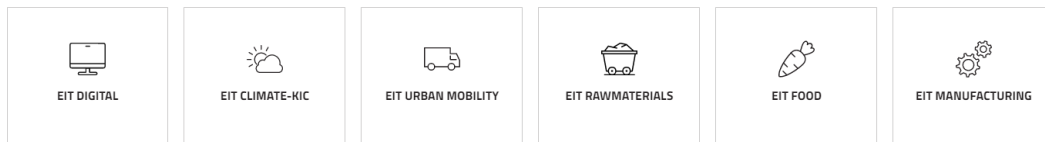

Fig. 75. EIT HUB SYLICON VALLEY Communities of Interest. Source: <https://go-eit.eu/eit-silicon-valley-hub/> [341].

The programs of a HUB (**Activities**) can be seen on Fig. 76. below.

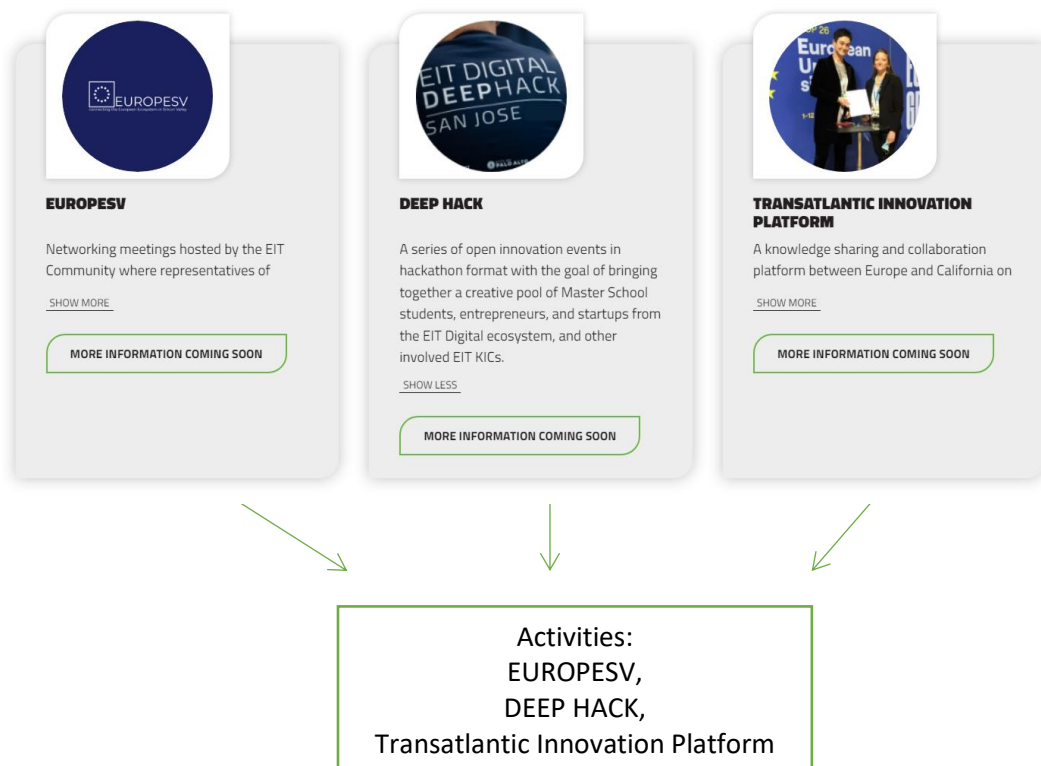

Fig. 76. EIT HUBSYLICON VALLEY Activities. Source: <https://go-eit.eu/eit-silicon-valley-hub/our-programmes/#programmes>

Also, the HUB organizes many **Events** [342], which can be seen on Fig. 77. below.

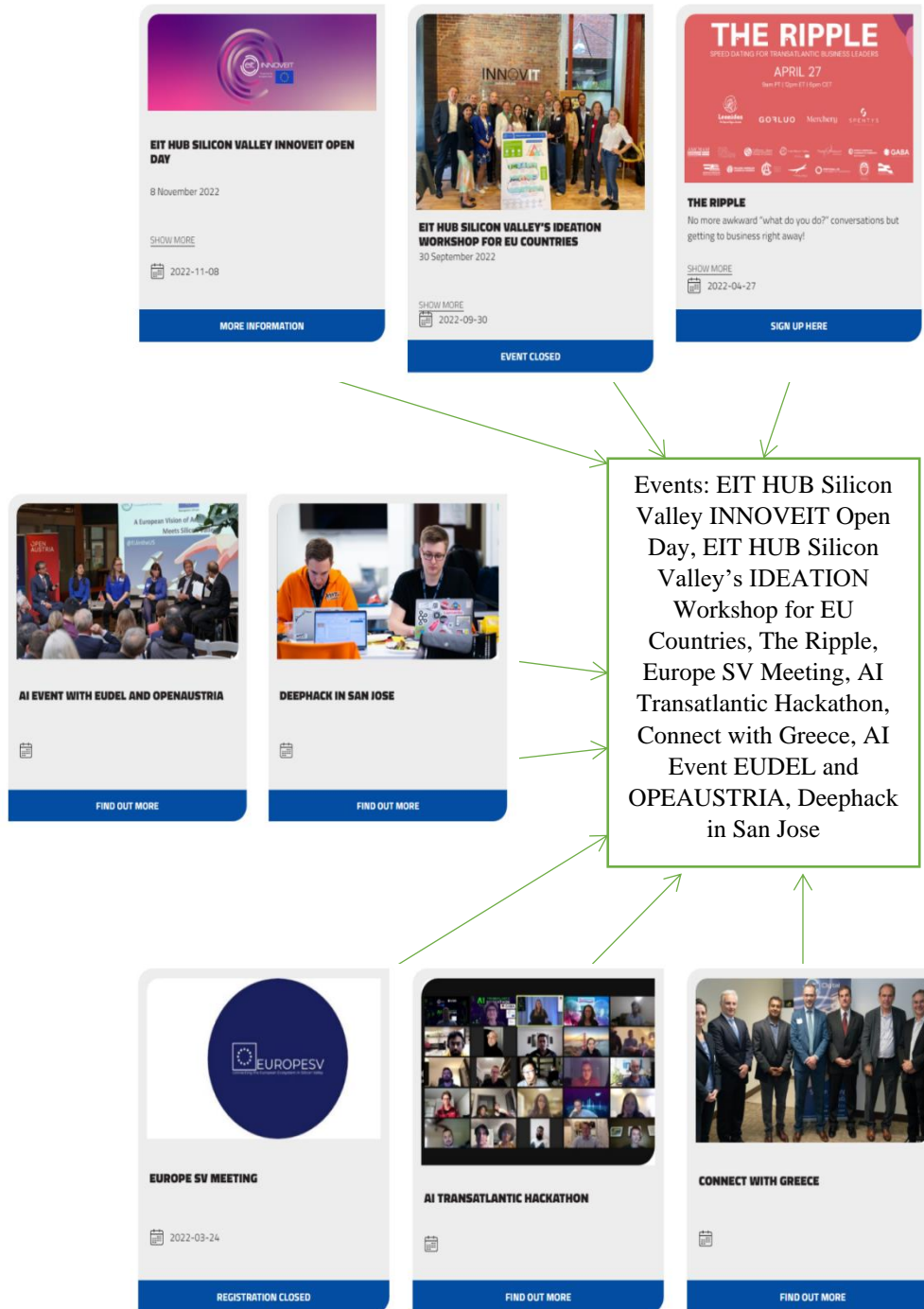

Fig. 77. EIT HUB SYLICON VALLEY Events. Source: <https://go-eit.eu/eit-silicon-valley-hub/our-programmes/#events> [342].

The HUB's **Value and Value Proposition** can be seen on Fig. 78. and Fig. 79. below.

## BRINGING EUROPE AND CALIFORNIA EVEN CLOSER

The infographic is divided into two sections. The top section, 'OUR VISION', features a brain icon and states: 'To be the bridge between Europe and California, leveraging both economies and empowering entrepreneurs and corporates alike to make a societal impact.' The bottom section, 'OUR MISSION', features a network icon and states: 'The EIT Hub Silicon Valley strives to create synergies between the EIT community and the Silicon Valley innovation ecosystem to support the growth of innovative startups and increase the number of Europe-California and Cross-KIC collaborative projects.'

Fig. 78. EIT HUB SYLICON VALLEY Value and Value Proposition. Source: <https://go-eit.eu/eit-silicon-valley-hub/who-we-are/> [343].

## WHAT WE DO

EIT Hub Silicon Valley enhances European leadership and know-how in California to address the world's major challenges and establishes itself as an effective liaison between the innovation ecosystems of Europe and California.

[SHOW MORE](#)

Fig. 79. EIT HUB SYLICON VALLEY also Value and Value Proposition. Source: <https://go-eit.eu/eit-silicon-valley-hub/who-we-are/> [343].

In this subchapter, two interviewing sessions were conducted; firstly, with DIH experts from EC and national authorities, and then also with experts from different DIHs. Selected DIH cases from DIH expert literature chosen for DIH RMM design were deemed suitable, as well as the referent architectures put in DIH context. Also, initial DIH model and metamodel were verified, and attention was given to missing, unnecessary or incorrect DIH RMM artifacts/elements, which provided basis for adjustment of DIH RMM. The interviewees were able to recognize real world concepts and do mapping between M0 and M1 conceptual levels.

Also, much information was gained regarding EDIHs. There were some limitations regarding the in-depth interview resources, which primarily pertain to time and available personnel for interviewing, but those obstacles were overcome.

## 6.2. Validation

Following VDML DIH metamodel verification, DIH RMM was **validated by focus group**. In case of contradictory opinions in the focus group, model can be extended, reduced or have isolated elements. Methods for conflict resolution methods can also be used. Focus group was composed of four DIH experts from Croatia or other EU Member States, in order to confirm the model. Focus group interviews were held between 20 March 2023 and 03 April 2023.

The protocol of the interviews was following the three steps described in text below:

1. Members of the Focus group were shown DIH RMM composed of different variants of M1/1 DIH VDML. Explanations of the genesis of different versions was explained. Interviewees were asked for their opinion regarding DIH RMM creation logic and for the possible remarks regarding DIH RMM elements.
2. Practical examples of DIH RMM were explained; DIH Catalogue and examples EID HUBs for which DIH RMM could also be used. Interviewees were to state their opinion.
3. The main conclusions of this dissertation were shown to interviewees, and they were asked for their opinion.

Information and opinions gathered from the interviewees were carefully read and studied. Then, recognized claims were clustered around alike concepts and placed in the Table 10. below.

Table 10. List of Focus Group Claims. Source: Interviewees.

<b>List of Claims</b>	
<b>List of claims pertaining to DIH RMM different variants of M1/1 DIH VDML</b>	
<b>a) DIH out of region participants</b>	
C1	<i>-DIH ecosystem participants should be regional (most should be local or regional, collaborating in close network or ecosystem, everything else is difficult to manage, should be manageable), could participate with out of region entities, depends on the size of DIH</i>
C2	<i>- most DIHs are regional initiatives, mainly based on activities and services which they provide (DIHs should be in the region, and EDIHs should be used to get out of the region/state)</i>
C3	<i>-DIHs have regional focus, but it is possible to use another DIHs perspective (if someone from the region wants to profit from this know-how). A participant has to be in the specific region, also because DIHs get money from the government. EDIHs are for out of the region</i>
C4	<i>-DIHs can work with entities out of region (to find the competences)- this is why the network exists (to know who to contact if you are missing something). DIH s should primarily serve local companies and administration, that is true. DIH should not necessarily ask EDIH to go out of the region-</i>
C5	<i>-clients should come from different regions (that was imposed by Digital Europe Programme)</i>
C6	<i>-with distance, language, culture and organization can become a problem, so there has to be a strong driver- why do you have to go somewhere else (you cannot find someone)- theoretically yes, but there has to be a strong driver for going out of region</i>
<b>b) What should be internal and what should be external to DIH</b>	
C1	<i>-depends how you define a DIH (what is internal or external)- internal are all service providing entities, and external are receivers (providers are internal and receivers are external)</i>
C2	<i>-Only DIH office should be internal</i>
C3	<i>-it's one-dimensional to think that only DIH office should be internal- if we only stay within our cocoon (RTO) it is narrowminded, we have to go broader. Company might not be able to be in the center, especially if they are large in size and have their own interests (products).</i>
<b>Other possible uses of DIH</b>	
C1	<i>-DIH RMM is a framework for best practices- how to construct a DIH, a bit complicated to people who are not familiar with this kind of work -origins of a DIH are not always the same</i>
C2	<i>-can be used as a guideline for building this kind of networks, finding gaps</i>
C3	<i>-ISO standards of how you work</i>
C4	<i>-KPIs and how you measure them,</i>
C5	<i>-how to receive ceil of excellence - benchmark to get more money from the government)</i>



C6	<i>-use of DIHs for evaluation of innovation HUBs</i>
C7	<i>-existing DIH catalogue is not very well structured, not much detail, DIH RMM would help</i>
C8	<i>-DIH RMM could be used for EDIH catalogue as well</i>
C9	<i>- a SME does not care who are my business partners, networks, collaborations, just what a DIH can provide (Value and Value Proposition). But for another DIH, EDIH or company who wants collaboration, it would be interesting to see these other things like communities of interest a DIH is in etc.</i>
C10	<i>-could be used for EIT catalogues as well (EIT is more for projects, they get money for projects, and DIHs are brokers who do not get money for projects, but the way they are set up is the same)</i>
C11	<i>-menu in DIH catalogue is not detailed enough when it comes for example to specific technologies (some cross different things not only AI or construction- for example buildings-energy domain)- predefined menu is not allowing DIHs to find themselves- it is too one size fits all- limitations can be improved, but as a general tool it does the job</i>
C12	<i>-example for DIH RMM use would be within certain KICs (Knowledge Innovation Communities) which have hubs</i>
C13	<i>-DIH RMM could be applied to online communities (to create online communities)- some EDIHs intend to use it, as a way of connecting in order to offer knowledge, facilitate matchmaking, marketplace for demand, can be a tool for delivering knowledge in terms of online events, a place for safe and restricted communication- maybe DIH RMM could be used for organizing these kinds of online communities+ interesting to those who want to create a new DIH (there is no one model, but I can narrow it down to possible models, tailored to the context of their working), not benchmarking of already existing but setting up a new DIH/EDIH</i>
<b>Other matters</b>	
C1	<i>-DIH does not only have DIH web page, but also different social media presence (social media is more important than the web page)</i>
C2	<i>-social media is important for DIHs</i>
	<i>-social channels are multipliers in raising awareness of what DIHs can offer – communication marketing strategies are very important, a well thought through communication strategy in order to be known as a point which companies can go to</i>
C3	<i>-in IT and specific domains KT/TT does often go from industry to academia (if you are IT PhD student in a specific domain like AI- interesting when you put that person together with a clinician with a real issue and the he solves it- more value when collaborating with industries then being only a researcher in academia- the product would be market ready or as close as possible to the market- all this is more important than it used to be in the past</i>
C4	<i>-there are many non-tangible things in structures like DIH- difficult to make it objective (what is “to facilitate” for example) ...</i>
C5	<i>-DIH RMM- some explaining will be needed to managers</i>

C6	<i>-DIHs should be involved with innovations- it is a combination of innovation and digitalization tools, the focus is on innovation but it depends on the meaning of innovation (the purpose of innovation is to increase prosperity and wealth of community, in this case from digital transformation (just to use digital tools is not innovative)</i>
C7	<i>-Not much difference between DIH and EDIH- one gets the money and the other does not- DIH is not obliged to cooperate with Europe and that is the main difference, with EDIH, cca 20% services have to be delivered out of state and vice versa (20% of services have to be received from out of state). Other than that (structure and all), they are completely the same</i>
C8	<i>-DIHs are supposed to be a consortia of partners with complementary expertise (university with expertise who needs someone who is politically strong, business partner, research center with a lot of capabilities- 100% of complementary expertise, so you can give 100% of everything)</i>
C9	<i>-KT and TT form industry to university in technical fields- for sure</i>
C10	<i>-it is possible that a DIH can successfully function without public finance (for example, after several years of operation, initially funded or co-funded with public fin. support, but then is fully self-sustaining-self-sustainment should be evolution of a DIH- there are limits to the public funding)</i>
C11	<i>-in the end, it is all about the people who fork for a DIH/EDIH</i>
C12	<i>-KT/TT from industry to academia happens with companies who are innovators in their nature (innovation challenged by a different market need/challenge and research is helping with a little bit of fine tuning, and company is bringing market dimension- trough that collaboration, product will be more ready to be launched on the market). Big companies have their own R&amp;D but they absorb innovators.</i>
C13	<i>-EDIH is a DIH on steroids. Time will tell if these networks bring added value (knowing each other, connecting us), even though no one asked for this network.</i>
C14	<i>-ecosystem (everyone) and innovation ecosystem is not the same; if a DIH is about innovation, it should relate to innovation ecosystem (it should be about innovation). Electric vehicles company does not develop charging stations and they need each other- that is innovation ecosystem. They work directly or on a distance, but need each other).</i>
C15	<i>-it should be more about innovation and not just KT. Helping digitally illiterate company is innovation for them, but not what the focus should be on.</i>

All participants agree with DIH RMM design logic and also with main conclusions of the thesis. The list of claims pertaining to the versions regarding weather a DIH should have out of region participants and what would be internal to a DIH show that all variants of M1/1 DIH VDML should be kept.

### 6.3. Chapter conclusions

Fourth Phase was conducted through verification and validation. Qualitative in-depth interview was conducted, in order to collect the information from DIH experts and satisfy the verification process. Two interviewing sessions were conducted; firstly, with DIH experts from EC and national authorities, and then also with experts from different DIHs. Selected DIH cases from DIH expert literature chosen for DIH RMM design were deemed suitable, as well as the referent architectures put in DIH context. Also, initial DIH model and metamodel were verified, and attention was given to missing, unnecessary or incorrect DIH RMM artifacts/elements, which provided basis for adjustment of DIH RMM. The interviewees were able to recognize real world concepts and do mapping between M0 and M1 conceptual levels. Also, much information was gained regarding EDIHs.

Following VDML DIH metamodel verification, DIH RMM was validated by focus group. All participants agree with DIH RMM design logic and how it is related to the practical examples displayed, and also with main conclusions of the thesis. The list of claims pertaining to the versions regarding whether a DIH should have out of region participants and what would be internal to a DIH show that all variants of M1/1 DIH VDML should be kept.

## 7. FIFTH PHASE EXECUTION: DISCUSSION OF RESULTS

In the fifth phase, Conclusions, proposal of RMM DIH will be designed, and degree of compliance and incompatibilities of DIH with VDML metamodel will be provided. This chapter will explain alignment with objectives and hypotheses. Conclusions will be made, based on theoretical and practical research conducted.

### 7.1. Main Objective No1

The first main objective is: (1) Identification of factors which influence intermediaries in VD from research community to industry and vice versa.

In the scientific theory of KT from research community to industry and vice versa, the focus of the thesis narrows down to intermediaries. These intermediaries in VD are influenced by different factors. Some of these factors were identified through expert and scientific literature review, and come through the practical part of the research. The ones generated from the literature review will be discussed first.

One of them are **different strategies and policies**, such as S3; EU Member States have different S3 strategies, with a list of research and investment priority areas in accordance with European Cohesion Policy 2014-2020 [25]. DIHs, a special kind of intermediaries, are the focal point of EC's Digitalizing European Industry Strategy from 2016 [6]. That makes DIH a policy instrument for availability of DT support [110]. Even though DIHs provide help to companies of all sizes with digitalizing their businesses [10], since SMEs take credit for 99% of entire EU business [9], that makes **the size of the company** asking for help in triage an important factor influencing DIHs clients' structure.

Also, DIH concept was introduced because EU digitalization level should not be so heterogenous in order to become more competitive on internationally [10]. So, another factor which influences DIHs, or their necessity is the region/state **level of digitalization**. Due to the fact that DIHs are to be the first points of contact in region [10], **proximity** is also important factor, for geographically isolated and poorly populated locations have difficulties in performing their businesses [24]. **Financing** is also an important factor, also for DIHs, and it is usually maintained through membership fees, public funds, and commercializing their selected specialized services [116]; whilst most DIHs are not directly financed by their respective S3s [117].

As DIH and EDIH services descriptions overlap, so are the factors influencing them the same or very similar. Since EDIHs should be multipliers and diffusers of the use of digital capacities in support of Digital Europe Programme's objectives in the areas of Cybersecurity, AI, Advanced Digital Skills, HPC and should be accelerators of technologies' best use [121, p. 7],

**different EC programs** which define different areas for which intermediaries are to be used. Another example of why EC programs are a factor influencing intermediaries is also the fact that performance of EDIHs will be based on several elements written in Digital Europe European Digital Innovation Hubs Work Programme 2021-2023, where targets and indicators to be evaluated are explained which ones will be collected by DTA [124, p. 11].

**DIH performance evaluation**, in terms of EDIH indicators and metrics Key Performance Indicators (KPIs), is definitely a powerful factor giving direction to EDIHs. There are different **official entities** influencing the work of certain kinds of intermediaries. DTA is a factor influencing EDIHs. Its purpose is providing support to EDIHs and accelerating DT of European economy, with the following main objectives: online presence, external communication, tools, training, community building, connecting to relevant activities, impact assessment, road mapping and support [123]. For EDIH customers’ digital maturity increase, JRC developed methodology [124, p. 11], which makes JRC also a factor influencing intermediaries.

These factors influencing DIHs and EDIHs as intermediaries derived from mostly expert literature review, can be summarized as follows in Table 11. below, based on Author’s conclusion derived from mostly expert literature.

Table 11. Factors Influencing DIHs and EDIHs with examples. Source: Author’s conclusion derived from mostly expert literature.

<b>Factor</b>	<b>Example</b>
strategies	S3
policies	European Cohesion Policy 2014-2020, Digitalizing European Industry Strategy
EC programs	Digital Europe Programme
size of the company asking for help	SMEs
level of digitalization	highly digitalized, poorly digitalized
proximity	geographically isolated and poorly populated locations
financing	membership fees, public funds, and commercializing their selected specialized services [116]; most DIHs are not directly financed by their respective S3s [117]

performance evaluation	EDIH KPIs
official entities	DTA, JRC

As was previously explained in section 3.1.8., scientific literature recognizes about 50 **problems with intermediaries** in KT processes from research community to industry and vice versa, thus they were clustered, forming the three main categories: (1) Personnel Factors, (2) Business Organization and (3) Stakeholder Management. The is summarized and displayed in the Table 12. below, based on Authors own conclusion based on scientific literature review.

Table 12. Factors Causing Problems with intermediaries in KT processes from research community to industry and vice versa.

Factor	Example
(1) Personnel Factors	underpaid [125] [126] [127], under-capacitated [127], lack of marketing experts [125] [126] [127], lack of legal experts [127], lack of licensing experts with negotiating skills [126], lack of licensing experts with negotiating skills [126], too short involvement [128] [127], lack of personnel with business [126] [127], knowledge transfer experience [127]
(2) Business Organization	bottlenecks [129], bureaucracy [125] [126] [104], complexity [130] [104] [126] [131], stimulating measures [127], inefficiency [127], inflexibility [125] [126], service value immeasurability and invisibility [128], too long time from patent application to release of permit [132] [126])
(3) Stakeholder Management	dual agent role- balancing professors and universities [127], differences in organizational cultures between research community and SMEs [135] [125] [126] [127], proximity [105] [104], stimulating members of research community to reveal their discoveries [125] [127], asymmetric information problem [127], balancing expectations of academic freedom [132], knowledge sharing diffusion and use [102], promotion of regional economic development vs. industrial interests such as profit maximization, growth and competitive advantage [132], balancing expected demand and supply [128], matchmaking [133] [127]

Those problems are also factors which the scientific literature recognizes as the ones influencing intermediaries in VD from research community to industry and vice versa, in KT processes. It is evident that the majority of those factors fall into the Stakeholder Management category.

Researching the scientific literature on KT from research community to industry and vice versa, it becomes obvious that there are some general topics that appear. They all as factors influence intermediaries. They are the following: **networking, social capital, the helices, patents and intellectual property matters, intermediaries, and other general matters** which don't fall into any of the above-mentioned topics.

In networking- related articles, some elements/factors are reoccurring in scientific literature and stand out as most important; **network cohesion, range, size, proximity, boundary spanners, clusters and broader set of knowledge resources**. Social capital is usually considered the most important asset of any organization. As such, it for sure has a well-deserved place in scientific literature, and some of the elements/factors which stand out as important are: **scientist seniority, cultural differences, autonomy, cross-boundary relationships, academic entrepreneurs, entrepreneurial academics, and finally cognitive and relational social capital**.

The helices are also often mentioned. In the literature review performed for the thesis, **TH** and **QH** occurred; the interconnection of different stakeholders in processes of KT has an immense impact on the synergy created. Patents and Intellectual Property Matters takes a significant part of scientific literature as well. In scientific literature on the topic of patenting, some of the terms often mentioned are **absorptive capacity, commercialization and ownership**.

Most reoccurring themes were easily clustered through KT literature review and themes which did not fit into any clusters were placed separately. These factors influencing intermediaries, which are also derived from literature, can be summarized as follows in Table 13. Below, based on authors own conclusion based on scientific literature review.

Table 13. Factors impacting intermediaries in KT processes from research community to industry and vice versa recognized in literature.

Factor	Example
networking	network cohesion, range, size, proximity, boundary spanners, clusters and broader set of knowledge resources

social capital	scientist seniority, cultural differences, autonomy, cross-boundary relationships, academic entrepreneurs, entrepreneurial academics, and finally cognitive and relational social capital
the helices	TH, QH
patents and intellectual property matters	absorptive capacity, commercialization and ownership
intermediaries	described in Table 5. above
other general matters	KT channels, academic consulting, KT activities, knowledge enablers, occupational boundaries, boundary spanners, engaging external engineers, barriers, innovations, collaboration choices, human mobility, highly skilled professions and funding

When it comes to scientific articles dealing with TT from research community to industry and vice versa, the clustering of articles by themes also came naturally. Those topics are: Commercialization, Funding, Innovation, Intermediaries, Models, Patents, Policy, Social factors, Spin-offs and Start-ups, and UI Collaboration, and Other TT matters.

Some attention was given to basic aspects of commercialization, and some of the terms which appear the most are: activities, collaborations, technological knowledge transfer, different Acts, licenses and patents, economic growth and inventions. In order for TT to happen, access to funding is necessary. Some of the terms which appear in scientific literature regarding funding in relation to TT are: FDI, investment strategies, research funded by the industry, expenditure for research and development, private funding, and investment in innovating.

TT transfer is connected with innovation, and the terms related to it are: innovation activities, government sponsored programs, open innovation networks, regional innovation level, innovative strategic model, effects on sustainable growth and innovation landscape. Scientific literature mentions different business models regarding TT focusing on different TT aspects. The ones which are mentioned are the following: NtK Model, American and European models, The sustainable innovative academic entrepreneurship process model, TH model, open innovation models, free agency model, UTTBM, “intra-China”, “foreign nation–China” and “China–foreign nation”, subcontracted Innovation Model, Cooperative Innovation Model



(Consortia-Based Innovation Model), Open Community Innovation Model and different quantitative TT models.

Patents are also discussed, as an integral part of TT processes discussed in the literature review conducted. Scientific literature mentions different issues related to that topic like: reasons for not asking for patent protection, protection, IP ownership, TT channel, university patents, patent analysis and imitation. When it comes to defining TT processes, policy documents have a leading role. The most usual topics in the literature regarding TT policy are: IP policy, spin-off policies, start-up strategies, faculty and staff incentives and also issues like TT policy creation, conflict of interest, COP.

Social factors are important element of TT processes; articles on the topic of social factors in TT processes mention the following issues: enterprising norms, previous experience, mobility, culture, academic engagement, gender issues and personal values, goals and predispositions. Spin-offs and start-ups are often products/ side effect of TT processes. Scientific literature mentions spin-offs and start-ups in articles related to TT, and elements associated to them are related to university incubators, with which they have positive correlation with, USUI, issues related to different work speeds and interdisciplinarity.

UI collaboration is discussed also, as it enables TT through different entities and series of activities, with a different focus. In scientific literature, it is mentioned through IUCRCs, UI projects, collaborative research and teaching- focused activities. Other TT matters not being able to fit into any previously mentioned categories are described separately and discuss the following: absorptive capacity, degree of openness, risk assessment, TT barriers, Industry 4.0, internationally oriented companies, geographical proximity, TT strategies and agglomerations in form of a cluster.

Just like the factors appearing in scientific literature regarding KT from research community to industry and vice versa, these factors arising in TT literature regarding the same processes can also be summarized and seen in Table 14. below, based on authors own conclusion based on scientific literature review.

Table 14. Factors impacting intermediaries in TT processes from research community to industry and vice versa recognized in literature.

<b>Factor</b>	<b>Example</b>
commercialization	activities, collaborations, technological knowledge transfer, different Acts, licenses and patents, economic growth and inventions
funding	FDI, investment strategies, research funded by the industry, expenditure for research and development, private funding, and investment in innovating.
innovation	innovation activities, government sponsored programs, open innovation networks, regional innovation level, innovative strategic model, effects on sustainable growth and innovation landscape.
intermediaries	Different kinds
models	NtK Model, American and European models, The sustainable innovative academic entrepreneurship process model, TH model (Knowledge Triangle), open innovation models, free agency model, UTTBM, “intra-China”, “foreign nation–China” and “China–foreign nation”, subcontracted Innovation Model, Cooperative Innovation Model (Consortia-Based Innovation Model), Open Community Innovation Model and different quantitative TT models.
patents	reasons for not asking for patent protection, protection, IP ownership, TT channel, university patents, patent analysis and imitation.
policy	IP policy, spin-off policies, start-up strategies, faculty and staff incentives and also issues like TT policy creation, conflict of interest, COP.
social factors	enterprising norms, previous experience, mobility, culture, academic engagement, gender issues and personal values, goals and predispositions.
spin-offs and start-ups	USUI, issues related to different work speeds and interdisciplinarity
UIC	IUCRCs, UI projects, collaborative research and teaching- focused activities
other TT matters	absorptive capacity, degree of openness, risk assessment, TT barriers, Industry 4.0, internationally oriented companies, geographical proximity, TT strategies and agglomerations in form of a cluster

Throughout the practical research part, other factors can be drawn additionally regarding factors which impact DIHs and EDIHs. Examples are displayed in Table 15. below, based on Authors own conclusion and practical part of the research.

Table 15. Factors impacting DIHs and EDIHs with examples, recognized during practical part of the research. Source: Authors own conclusion and practical part of the research.

<b>Factor</b>	<b>Example</b>
<i>geographical proximity to other EDIHs</i>	<i>EC tried not to have EDIHs of the same orientation geographically to close to one another- national economy also has to give one euro for every euro EC gives</i>
<i>EC's KPIs</i>	<i>EDIHs are given EC's KPIs, which give direction of their work</i>
<i>EC's mandate</i>	<i>EDIHs receive funding from EC and therefore have EC's mandate (and KPIs)</i>
<i>S3</i>	<i>-EDIHs are mostly or completely aligned -most DIHs are at least somewhat aligned</i>
<i>EC's funding+ other funding sources and structure</i>	<i>-EDIHs get 50% pf funding from EC, nations have to find a solution for the other 50% -DIHs have to charge fees to some customers or for some services</i>
<i>EU bureaucracy</i>	<i>Some DIHs consider becoming an EDIH is of no extra benefit, because they consider EU a very bureaucratic organization and to access funds is a lot of work (a job besides a job), and it requires many people to manage this access to EU funds.</i>
<i>different activities and collaborations</i>	<i>EDIHs enable cross-border activities and collaborations</i>
<i>possessing a certain expertise</i>	<i>If an EDIH does not possess a certain expertise, it forwards the customer to another EDIH</i>
<i>providing services to public administration</i>	<i>Even a small improvement with public administration is a huge societal impact.</i>

So, in conclusion, the factors influencing DIHs and EDIHs as intermediaries in this thesis are derived from mostly expert literature. Scientific literature recognizes many problems with intermediaries in KT processes from research community to industry and vice versa. Those problems are also factors influencing intermediaries. Researching the scientific literature on KT and TT from research community to industry and vice versa, it becomes obvious that there are some general topics that appear. Those topics are added to the list of factors influencing intermediaries. Finally, throughout the practical part of the research, some additional factors were drawn regarding factors which impact DIHs and EDIHs as intermediaries.

## 7.2. Main Objective No2

The second main objective is: (2) Identification of DIH similarities and specifics in comparison to other intermediaries.

There are numerous intermediaries mentioned in scientific and expert literature regarding KT and TT from research community to industry and vice versa, all with similar missions which include bringing different stakeholders together in some number of helices. Some of those intermediaries are displayed in Table 16. below, based on Author's own conclusion and literature review.

Table 16. Intermediaries in KT and TT from research community to industry and vice versa and their functions.

KT/TT	Intermediary	Functions
KT	UKTOs, UIOs, UTTOs [4], TTOs [4] [100] [101]; KTOs [5] [97]; UTTOs [103]; UIs [104]; CRCs [104]; science parks [105], and DIHs [6].	KT
	RTOs [102]	key role in technology-innovation ecosystem; trough applied research and technology development in function of innovation, they also have to implement (S3) [106, pp. 3-4].
TT	collaborative innovation centers, strategic alliance of industrial technology, innovation national university science parks [192, p. 15].	Drafting contracts, negotiating rules, commercializing R&D activities results, partners' mutual understanding, filing the IP registration are some of the activities influenced of performed by intermediaries [186, p. 16]
	TTOs	-moderation of stakeholders in processes of technology management [196, p. 1065] - a role of the catalyst within TH; supports innovation, communication between stakeholders, new technologies and products, supports commercialization, ensuring compatibility of activities, ensuring maximization of socio-economic impact, and improves entire TT process [198, pp. 9-10]

TTA	more efficient solution than TTO for sharing services [187, p. 76]
CRC	promoting entrepreneurship, focusing on economic and social results through science and technology supporting and enhancing, its role and function having a focus on: networks, brokerage and collaborations; resource appropriation and enhancement; research impact addressing; and enhancement of research quality [199, pp. 3409-3410].
ERC and EC	support entrepreneurship, but through different means [199, pp. 3411-3424].
University technology parks	have the role of incubators; they lower the costs of transforming scientific findings in processes or products, and also help selling them [200, p. 108].
TT agent	it is a technologist in charge of TT process; finds solutions, studies user needs, creates and tests a prototype, and finally manufactures and sells the final product [166, p. 142].

There are also DIHs and EDIHs, as special kinds of DIHs, as intermediaries in KT and TT from research community to industry and vice versa. Their functions are somewhat different, and some examples are summarized in Table 17. below, based on expert literature, author's own conclusion and practical part of the research.

Table 17. DIH and EDIH functions.

<b>Intermediary</b>	<b>Functions (and other specifics)</b>
DIH	<ul style="list-style-type: none"> <li>- making the necessary DT support freely available [110].</li> <li>- help companies of all sizes with digitalizing their businesses through numerous one-stop-shop services, relying on KT and TT from technical universities or research establishments, positioned at their core [10].</li> <li>- "access to digital technologies and competences, infrastructure and training to test digital innovations, financing advice, market intelligence, networking opportunities, access to digital skills development and training" [111, pp. 2-3].</li> <li>- be the first regional points of contact, for the industries' DT demands [10].</li> <li>- try to create synergy by gathering different stakeholders, different EU Member States, regional policies, industry (with focus on SMEs), research entities and academia. DIH amongst other things also conducts matchmaking/brokering, through events, websites, showrooms, supplier networking, various different organizations' complementarities promotion</li> </ul>

	<p>[110], and also through hackathons, innovation camps, roadshows and workshops [26, p. 12]</p> <ul style="list-style-type: none"> <li>- support digital transformation of public sector, SMEs and mid-caps [8]</li> <li>- DT of SMEs as their main purpose [7].</li> <li>- gather different stakeholders and create synergy through engaging Member States' and regional policies, members of the industry (with special focus on SMEs), research entities and academia [7].</li> <li>- improve EU's competitiveness on international market through digitalization of four fifths of EU's SMEs, which are still not highly digitalized [10].</li> <li>- mediates and transforms knowledge and skills from providers to customers, whilst roles in this process can interchange</li> <li>- non-profit</li> <li>- <i>enabling SMEs to use available technology</i></li> <li>- <i>should be members of an active network with other DIHs</i></li> <li>- <i>involvement in numerous activities; main one is test before invest</i></li> <li>- <i>collaborate with actors of similar orientation; static dynamic nature</i></li> <li>- <i>facilitate development of projects between knowledge institutions/research institutes and companies, in order to develop new knowledge and to transfer mature knowledge to industry</i></li> <li>- <i>reaching out to customers (proactivity)</i></li> <li>- <i>deal with low TRLs</i></li> <li>- <i>incubation; support to SMEs in becoming ready to start, finding financing, getting the necessary education and facilities</i></li> <li>- <i>raising awareness about digitalization possibilities</i></li> <li>- <i>provide mostly free services and help find funding</i></li> <li>- <i>intelligence planning process which involves consultation and which services can be offered to help the company</i></li> <li>- <i>funding sources of funding</i></li> <li>- <i>some have collaboration with industry cluster, mostly established in state but also elsewhere in Europe, mostly with cluster organizations</i></li> <li>- <i>develop networks between DIHs in different regions/states and bring knowledge from different regions to their regions, so that they can be a bridge between different knowledge institutions</i></li> <li>- <i>more focus on the special branch, the focus is smaller, more open to different technologies and sustainability aspects, it is easier to compare/benchmark cross sectoral innovation topics (better/more progressive than the other entities)</i></li> <li>- <i>one-stop-shop for the region, allows talks about digitalization, presentations from universities regarding new technologies, demonstrations of best practices etc. (unlike akin existing structures in the region)</i></li> <li>- <i>S3 (mostly aligned)</i></li> </ul>
EDIH	Besides above mentioned for DIHs, also "(...) support on a large scale the digital transformation of (1) companies, especially SMEs and small mid-

	<p>caps, and/or (2) public sector organizations conducting non-economic activities” [97, p. 6]</p> <ul style="list-style-type: none"> <li>- provide different services “development, training and skills, testing before investing, finding investments, access to innovation ecosystems and networking” [121, p. 6].</li> <li>- multipliers and diffusers of the use of digital capacities in support of Digital Europe Programme’s objectives in the areas of Cybersecurity, AI, Advanced Digital Skills, HPC and should be accelerators of technologies’ best use [121, p. 7].</li> <li>-<i>providing services to public administration (even a small improvement with public administration is a huge societal impact)</i></li> <li>-<i>50% of the financing is covered by EC (experimental EU project because the budget has to be justified not only through expenses but also delivered services)</i></li> <li>-<i>KPIs prescribed by EC (therefore mandate as well)</i></li> <li>-<i>S3 (mostly or completely aligned)</i></li> <li>-<i>different activities and collaborations (cross-border with other EDIHs as well)</i></li> <li>-<i>educating companies about the possibilities they have and which can enhance their business, explaining what digitalization is</i></li> <li>-<i>will create network of more the 150 EDIHs all over Europe in constant collaboration</i></li> <li>- <i>cooperation should be targeted and focused.</i></li> <li>- <i>main focus is support to digitalization</i></li> <li>-<i>planning collaborations with other EDIHs, but mainly those who can bring value to them</i></li> <li>-<i>could be a success model which will work in every region.</i></li> </ul>
--	---

There are numerous intermediaries mentioned in scientific and expert literature regarding KT and TT from research community to industry and vice versa, all with similar missions which include bringing different stakeholders together in some number of helices. There are also DIHs and EDIHs, as intermediaries in processes of KT and TT from research community to industry and vice versa. Their functions are somewhat different. In essence, DIHs and EDIHs one-stop-shops are under EU’s initiative, unique entities throughout the whole Europe, aligned with s3, focused on the issues of DT and on SMEs, are non-profit, bridge between different knowledge institutions, gather different stakeholders and network them in their ecosystem. EDIHs’ functions overlap with DIHs’, they have a cross-border aspect, focus also on public administration, and since they receive 50% of the funding from EC they also have a larger mandate, bigger responsibility, and direction given through EC’s KPIs.

### 7.3. Main Objective No3

The third main objective is: (3) Design of DIH VDML metamodel, as a model of DIH value creation.

M0, M1/1 and M1/2 cognitive level of DIH Model representation were given in one of the previous parts of the thesis. Some additional information was acquired during the practical phase of the research, which gave some new insights, having an impact on the preliminary representation conducted in earlier stage of research. That information will be summarized in Table 18. bellow, based on practical part of the research and author’s own conclusion, which will be the basis for newer versions of representations.

Table 18. Novel information gathered and implications on M0, and M1/1 DIH VDML representations.

<b>Novel information gathered</b>	
<b>1.</b>	<i>When it comes to DIHs’ business networks, they include collaboration with research and financial institutions, which help SMEs ensure funding.</i>
<b>implications</b>	-on M0, add icon “Fin. Inst.” as an Actor and Participant -the same applies to M1/1; associate Fin. Inst.” as an Actor and Participant with “Funding Provider” which trough “Parties” associates to “Business Networks”
<b>2.</b>	<i>DIHs develop networks between DIHs in different regions and states, and bring knowledge from different regions to their regions, so that they can be a bridge between different knowledge institutions.</i>
<b>implications</b>	-on M0, rearrange “University/Res.Est out of Region” to be connected through “Other DIHs Out of Region” to the ecosystem -on M1/1 connect “Business Networks” icon to “OtherDIHsOutofRegion” -on M1/1 rearrange “University/Res.EstoutofRegion” to be connected through “Other DIHs Out of Region” to the ecosystem
<b>3.</b>	<i>DIHs must possess two groups of resources: a) skills, b) test beds/equipment; knowledge is very important but also the focus, digital skills but also test beds and test environments with access to hardware.</i>
<b>implications</b>	-on M0, add icon “Skills”, which is comprised of “External Skills” and “internal Skills” icons, connecting them to “Capability library” icon -on M0, “Testbeds/Equipment” icon is to be added, be composed of “Infrastructure (Internal/External)”, connecting it to “Capability Library” icon -on M1/1 do the same, rearrange associations accordingly



<b>4.</b>	<i>One of the proposals was to further elaborate University/Research Establishments as participants in DIH ecosystem; there are many industry associations and innovation entities created to improve innovation capacity in the local ecosystem, which is public but not entirely.</i>
<b>implications</b>	-on M0, connect “Partially public local industrial associations” and “Partially public local innovation entities” to “University/Res.Est and Business Actors in DIH Consortium”, as Actor(s) and Participant(s) -on M1/1, do the same accordingly
<b>5.</b>	<i>There is a significant part of private investment in business of a DIH, and that should also be well reflected on M0 DIH scheme.</i>
<b>implications</b>	-on M0, add icon “Private Investment” as an Actor and Participant, - the same applies to M1/1; associate “Private Investment” with “Funding Provider” which through “Parties” associates to “Business Networks”
<b>6.</b>	<i>It was suggested to change „university“ into „academia“ or „knowledge institution“ because there are different setups in different countries.</i>
<b>Implications</b>	-on M0 and M1/1, everywhere where it is written “University/Res.Est” will say “Knowledge Institution/Res.Est.”
<b>7.</b>	<i>Some other interviewees think that scientific, technological-developmental and demonstration infrastructure should be included in DIH (meta)model, and that key stakeholders in technologically oriented DIH ecosystems are universities and RTOs, so that it is better to include RTO instead of “research establishments”.</i>
<b>Implications</b>	-on M0, and M1/1, make “Tetbeds/equipment” consist of “Scientific Infrastructure Int/Ext”, “TechDevInfrastructure Int/Ext” and “DemoInfr Int/Ext” -on M0 and M1/1, instead of “Knowledge Institution/Res.Est.” put “Knowledge Institution/RTO”
<b>8.</b>	<i>Some also mention municipalities.</i>
<b>Implications</b>	-on M0 associate “Municipalities in/out of Reg” as an actor and participant to “Public Actors in Region (not part of DIH)” and to “Public Actors in DIH Consortium” -on M1/1 associate “Municipalities in/out of region” to “Public Actors in Region (not part of DIH)” and to “Public Actors in DIH Consortium”
<b>9.</b>	<i>Some interviewees believe that professional associations should be included.</i>
<b>implications</b>	-On M0 and M1/1 create “Professional Ass in/out of the Reg” as an actor and participant
<b>10.</b>	<i>Most DIHs have regional aspects but not all of them. In most cases, DIHs involve interaction with local actors in the region, and also with public actors.</i>
<b>implications</b>	-on M0, make <u>another variant</u> , without participants out of the region -on M1/1, do the same Now there will be Variant 1 and Variant 2 of the original M0 and M1/1 DIH VDML representation.
<b>11.</b>	<i>Some interviewees think that DIH is like a broker-cloud; in the external ecosystem are all the ones that are not direct partners, and in the internal</i>

	<i>ecosystem are its researchers (experts), ICT service providers, companies as partners in the network (everyone who is a provider). If there is a partnership agreement with for example business incubator or a chamber of commerce, they are all part of internal ecosystem, but if there is no partnership agreement, then those entities are a part of external ecosystem, whether they are a part of someone else's ecosystem or not. Whoever is in the DIH ecosystem is internal. External environment to a DIH are other DIHs all over Europe with their ecosystems.</i>
<b>implications</b>	-on M0, <u>another variant</u> is also to be made, where DIH ecosystem is drawn as internal and external; internal will remain "Knowledge Institution/RTO and Business Actors in DIH Consortium", "Partially public local industrial associations with partner agreement", "Partially public local innovation entities with partner agreement", "Public actors in DIH Consortium", "Fin. Inst.", "Internal Human Capital", "Skills" consist of "Internal Skills" and "Internal KT" only, DIH as VDS itself, "Tetbeds/equipment" with: "InternalInfrastructure", TechnicalInfrastructureInt, "Scientific InfrastructureInt", TechdevInfInt" and "DemInfrastructureInt"); "Private investment", "BusinessActorsoutofRegwithPartnerAgreement", "ProfessionalAssociationswithPartnerAgreement", "PublicActorsinRegion (Not Part of DIH)withPartnerAgreement", "Municipalitiesin/outofRegion withPartnerAgreement" "KnowledgeInstitution/RTOinRegion(Not Part of DIH)withPartnerAgreement", "PublicActoroutofRegionwithPartner Agreement" and "Business Actors in Region (Not Part of DIH) with partner agreement" will remain a part of the internal DIH ecosystem, and everything else will be external + "Policy" can be internal and external, and should be renamed to "Policy/Strategy" -the same with M1/1

This novel information implications gathered tough the practical part of the thesis research is to be implemented into design of DIH VDML metamodel, as a model of DIH value creation, created in this research earlier. Different versions were then made of M0 and M1/1 conceptual level DIH VDML metamodel representations. Through implementing these changes and additional information to M0 DIH VDML representation, some other minor corrections were also made where deemed appropriate on representation created earlier in research.

Firstly, four different variants of M0 DIH VDML representations were created and can be seen on Fig. 80., Fig. 81., Fig. 82., and Fig. 83. below:

1. Variant 1 of M0 DIH VDML was created taking into account novel information with implications number 1-9. It can be seen on Fig. 80.

2. Information with implications 10 is a “turning point”. Variant 2 of M0 DIH VDML also took into consideration novel information with implications 10, so novel information with implications number 1-10. It is the same as Variant 1 just without Participants out of the Region. It can be seen on Fig. 81.
3. Information with implications 11 is another “turning point”. Variant 3 of M0 DIH VDML took into consideration novel information with implications number 1-9 and 11, so without information with implications number 10 (meaning with Participants out of the Region). It is based on variant 1, but also took into consideration what should be internal and what should be external to DIH (stated in information with implications 11). It can be seen on Fig. 82.
4. Variant 4 of M0 DIH VDML took into consideration novel information with implications number 1-11. It is the same as Variant 3, without participants out of the region (because it includes information with implications number 10). It can be seen on Fig. 83.

Following the creation of these four different variants of M0 DIH VDML representations, different variants of M1/1 DIH VDML representations were created accordingly and depicted below on Fig. 84., Fig. 85., Fig. 86., Fig. 87., Fig. 88. and Fig. 89.:

1. On Fig. 84., Variant 1 of M1/1 DIH VDML representation is depicted. It is based on Variant 1 of M0 DIH VDML representation from Fig. 80.
2. On Fig. 85., Variant 2 of M1/1 DIH VDML representation is depicted. It is based on Variant 2 of M0 DIH VDML representation from Fig. 81.
3. Variant 3 was represented on Fig. 86. focusing on internal ecosystem (internal elements will be painted in dark purple color) and Fig. 87. focusing on external ecosystem (external elements will be painted in gray color). Because of the size of the representations, they would both not fit into one figure. It is based on Variant 3 of M0 DIH VDML representation from Fig. 82.
4. Variant 4 was represented on Fig. 88. focusing on internal ecosystem (internal elements will be painted in dark purple color) and Fig. 89. focusing on external ecosystem (external elements will be painted in gray color). Due to the size of the representations,

they would both not fit into one figure. It is based on Variant 4 of M0 DIH VDML representation from Fig. 83.

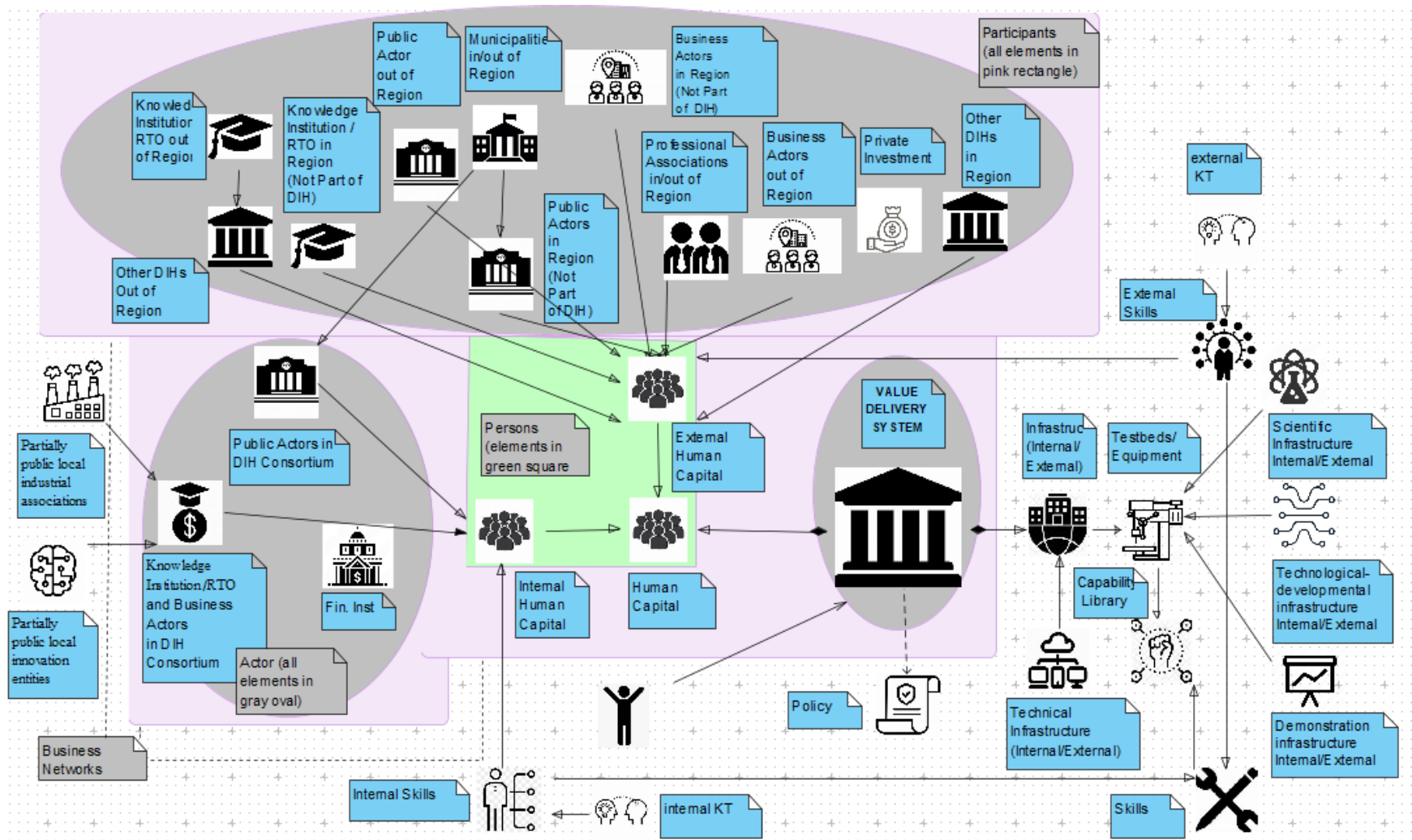

Fig. 80. Variant 1 of M0 DIH VDML.

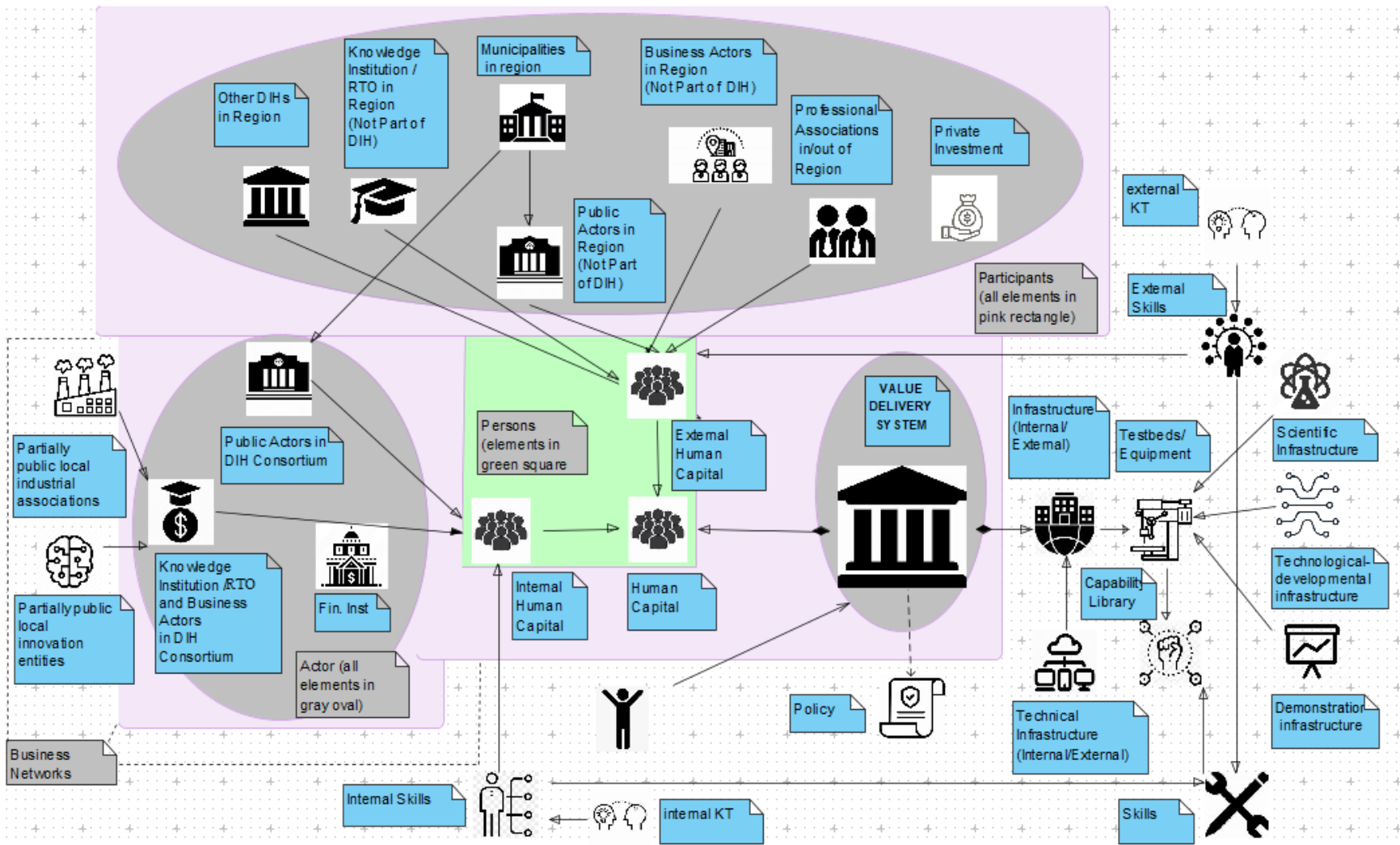

Fig. 81. Variant 2 of M0 DIH VDML.

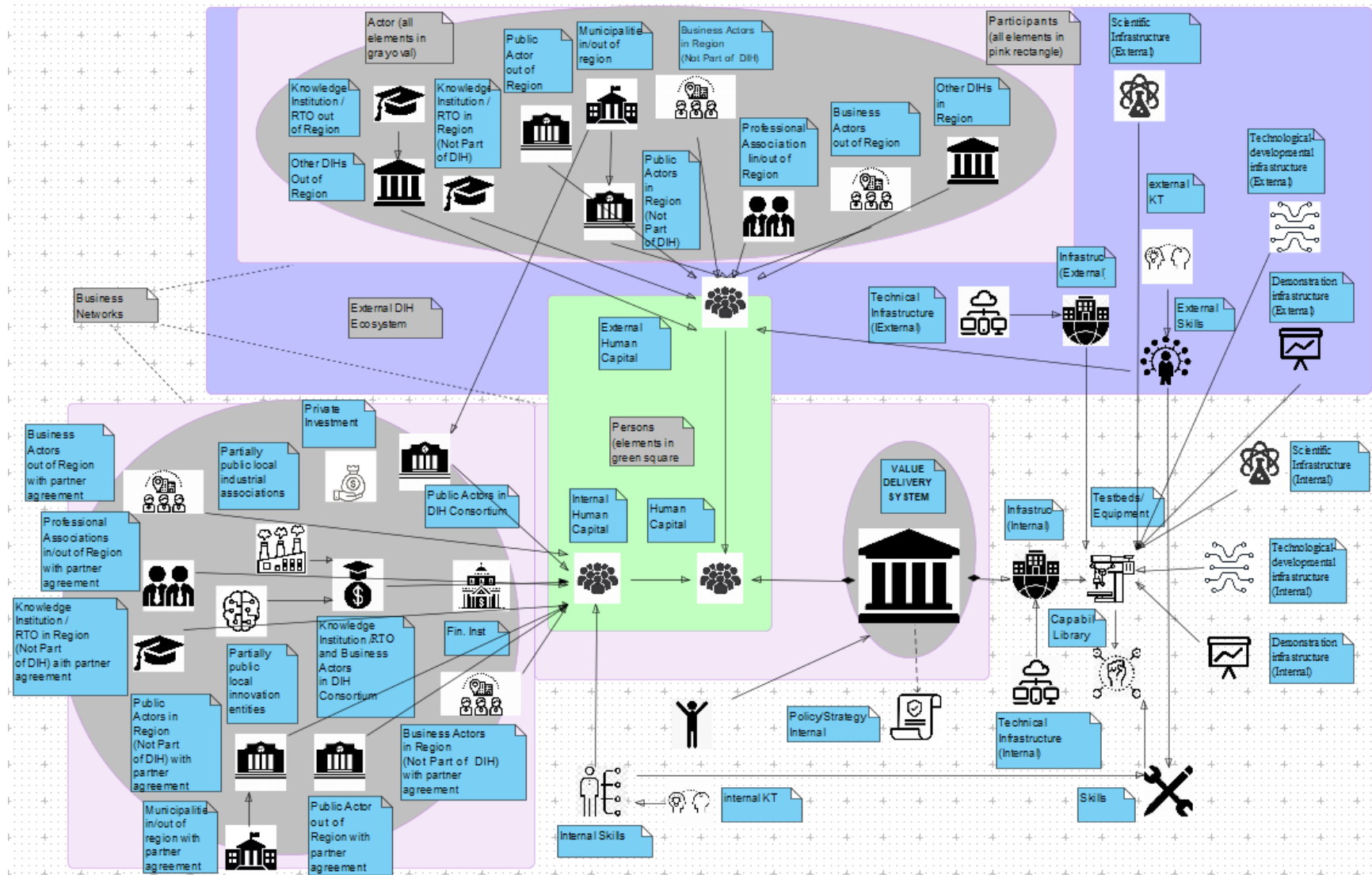

Fig. 82. Variant 3 of M0 DIH VDML.

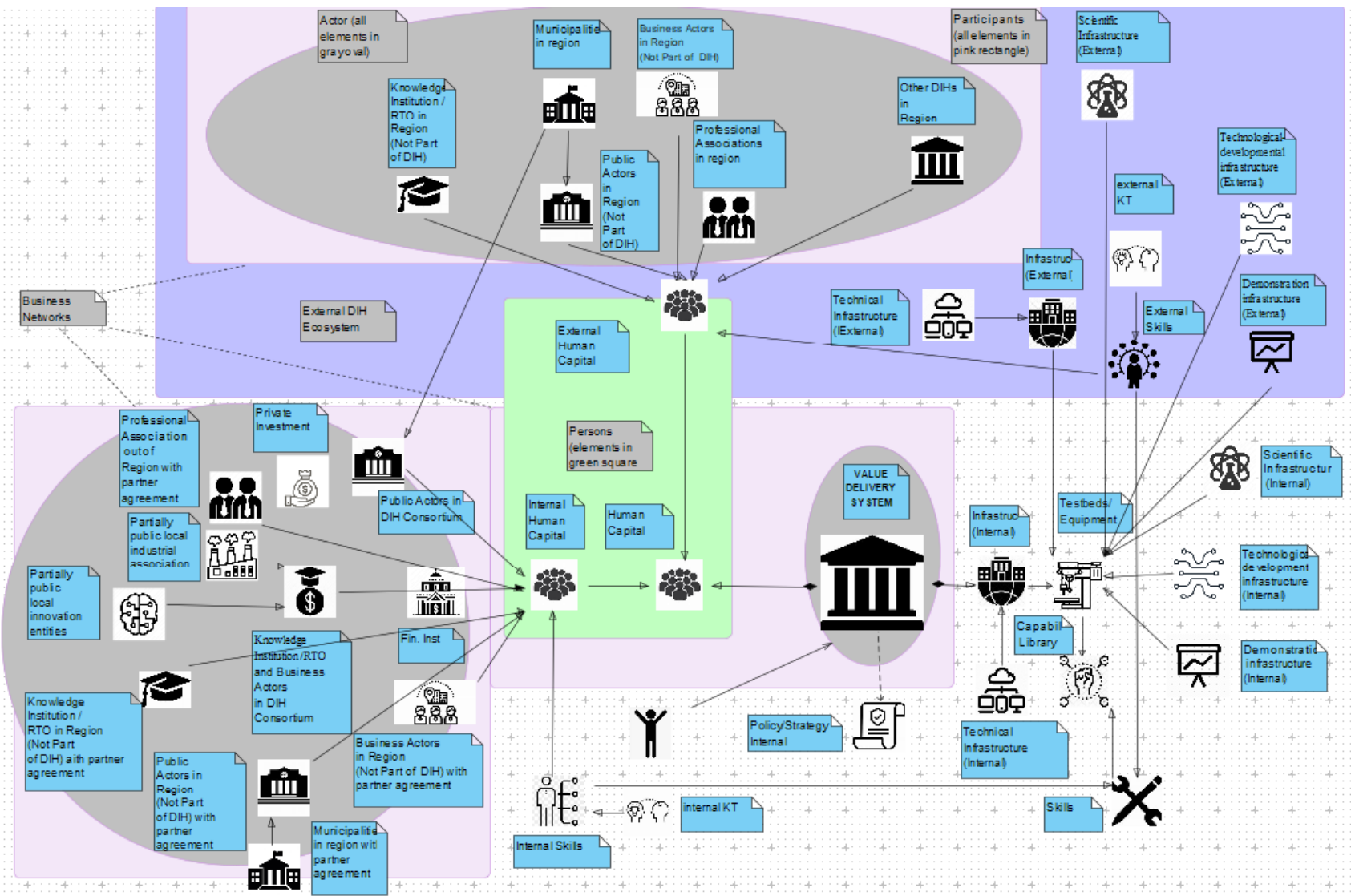

Fig. 83. Variant 4 of M0 DIH VDM.



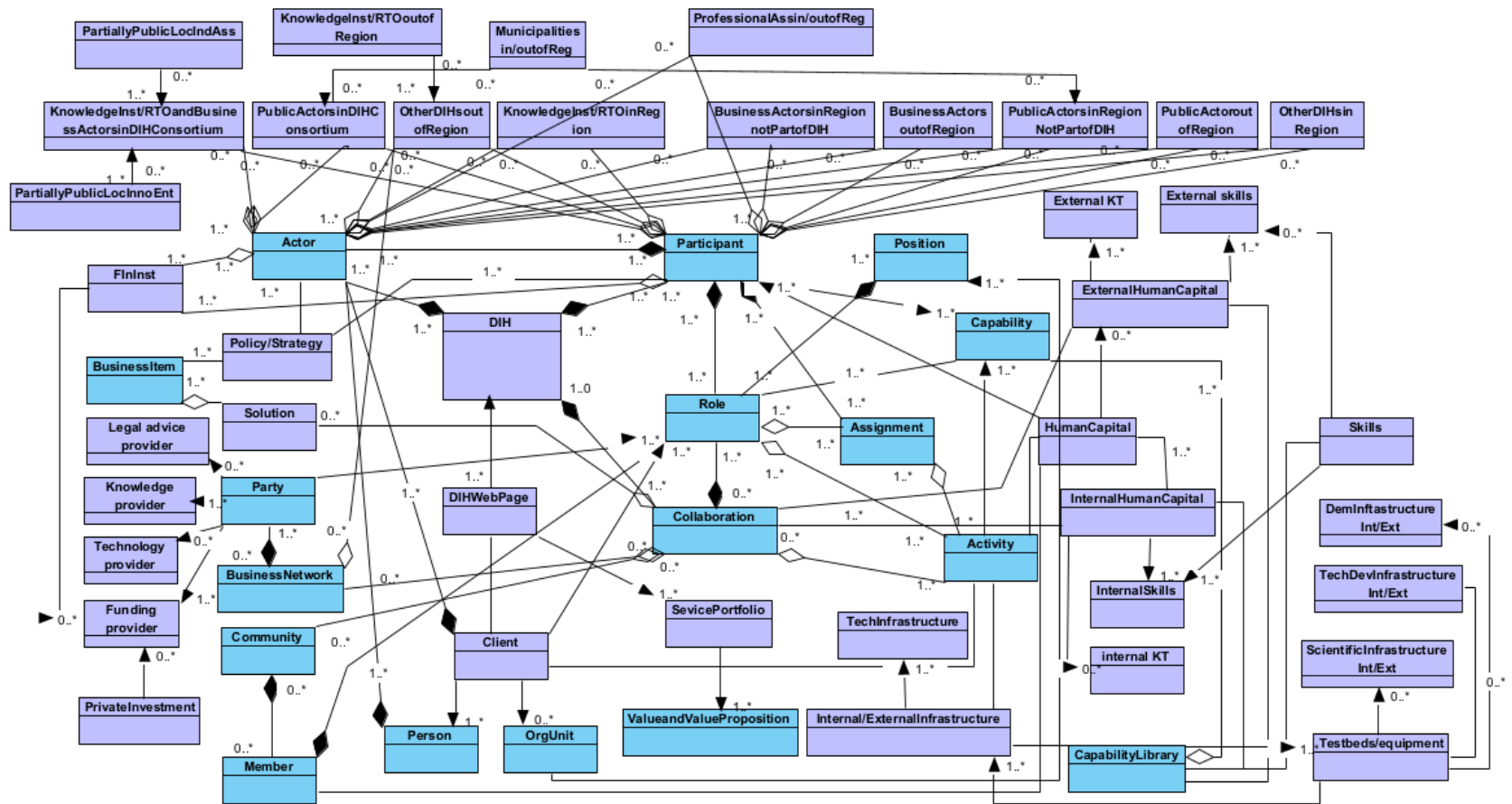

Fig. 84. Variant 1 of M1/1 DIH VDML.



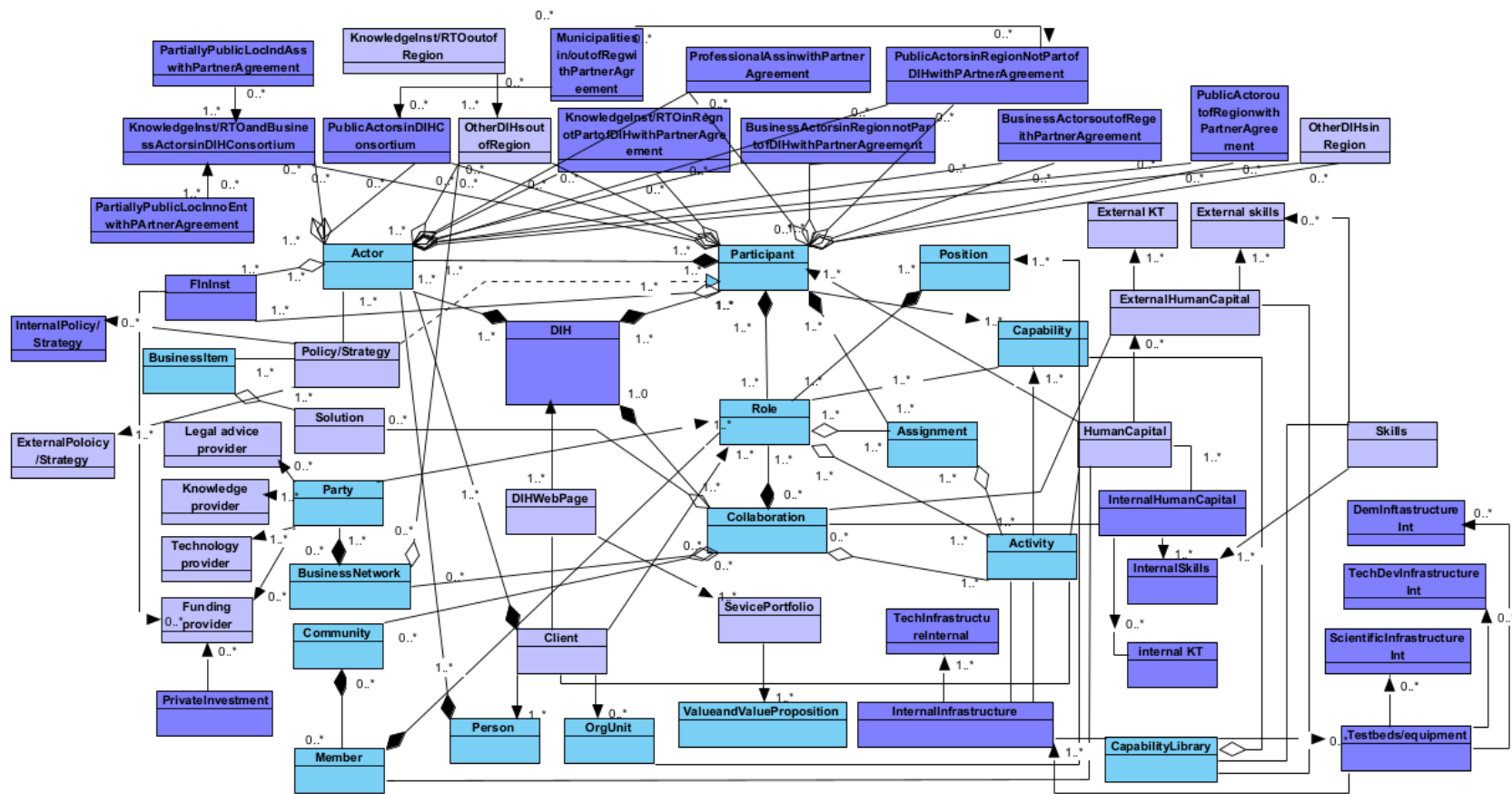

Fig. 86. Variant 3 of M1/1 DIH VDM (internal ecosystem).

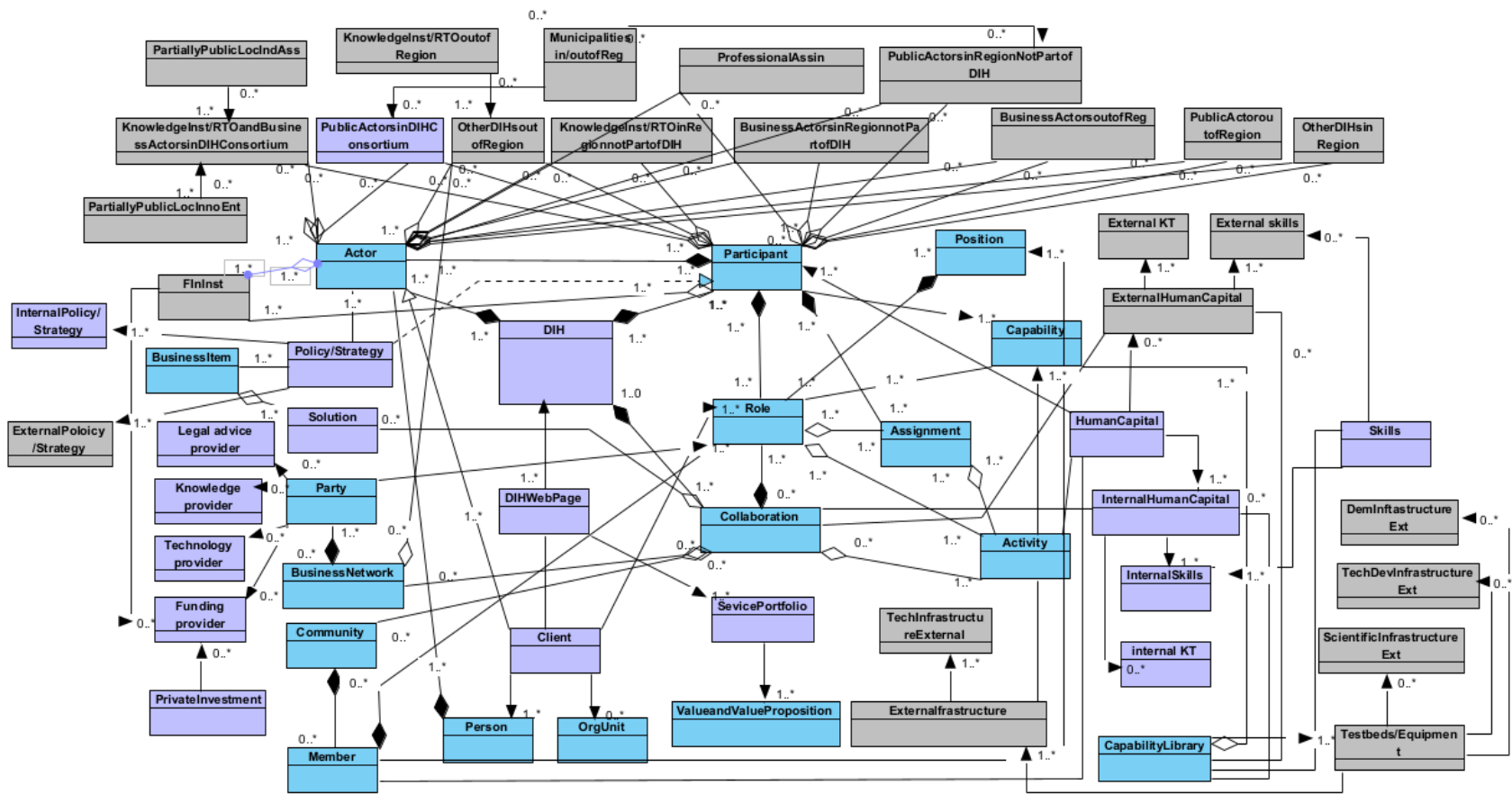

Fig. 87. Variant 3 of M1/1 DIH VDM (external ecosystem).

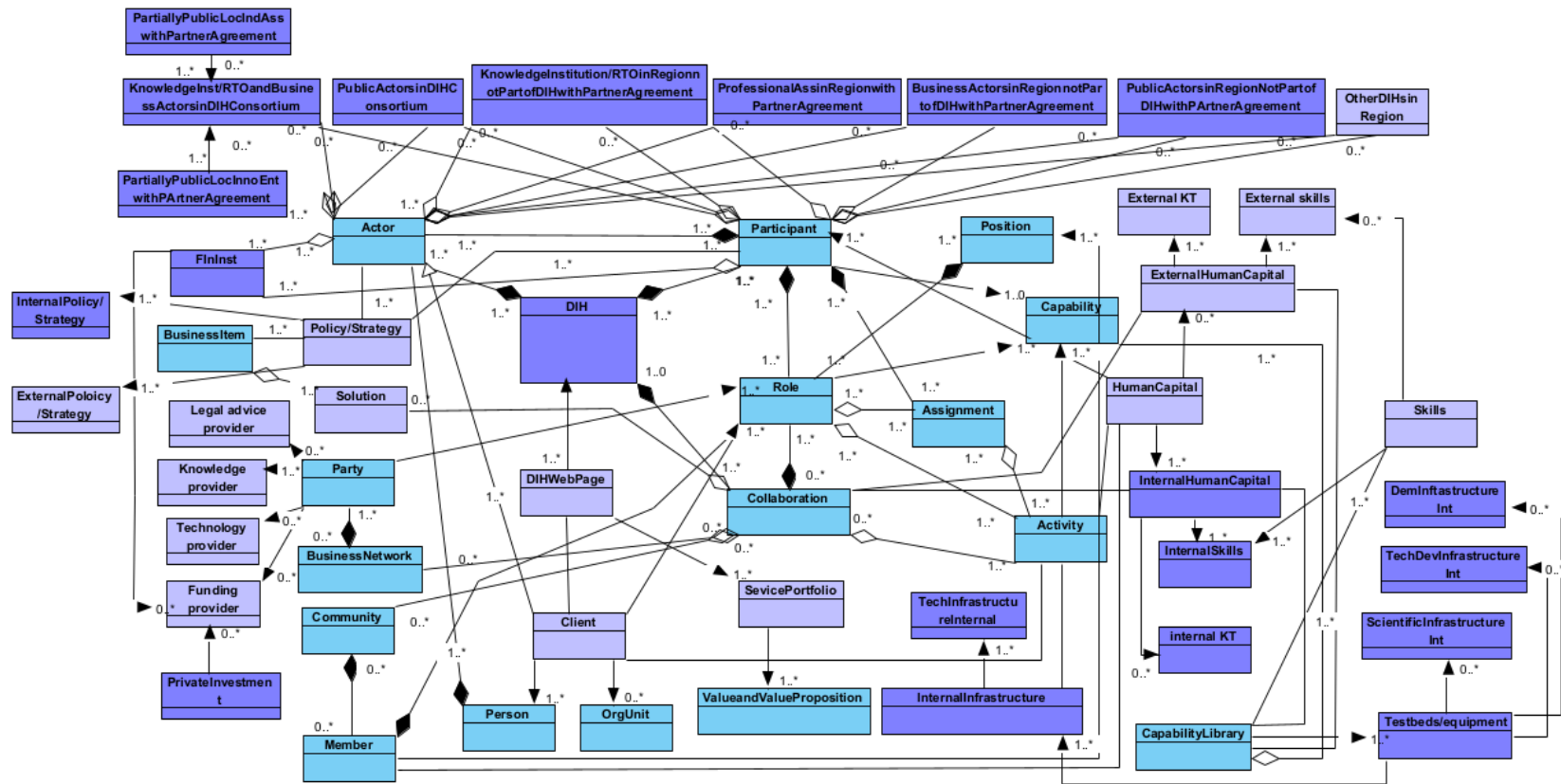

Fig. 88. Variant 4 of M1/1 DIH VDM (internal ecosystem).

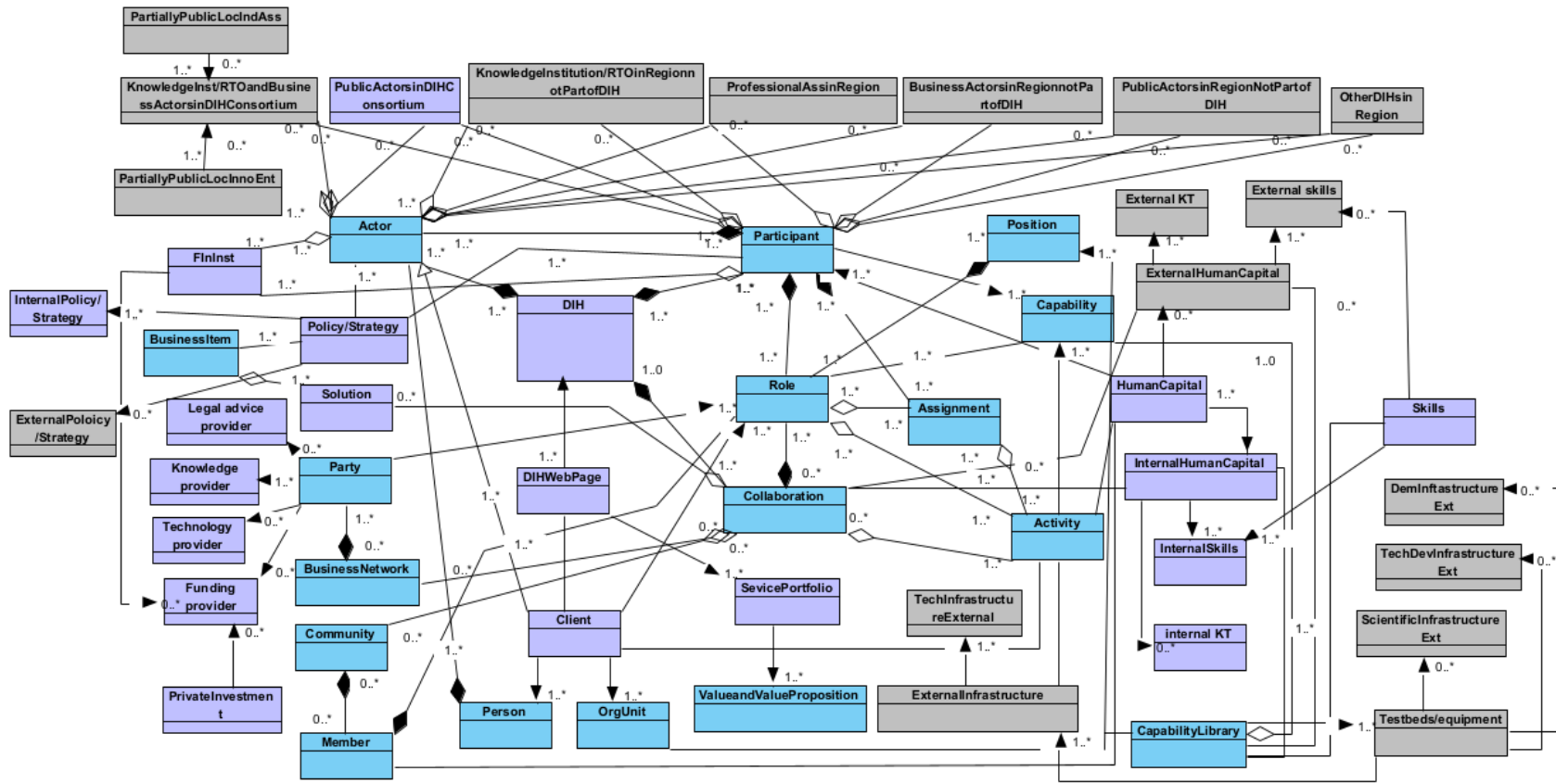

Fig. 89. Variant 4 of M1/1 DIH VDML (external ecosystem).

## 7.4. Main Objective No4

The fourth main objective is: (4) Establishing the degree of conformance of DIH with VDML metamodel.

The conformance analysis conducted earlier resulted with Table 23., Table 24, Table 25., Table 26, Table 27, Table 28, Table 29, and Table 30. in Appendix 3. From those tables, it can be concluded that VDML is fully conformant with DIH, meaning that every element of VDML metamodeling conformance also belongs to DIH, i.e., in DIH expert literature chosen for the research and deemed appropriate by interviewees. Some of the VDML elements can be directly found in DIH literature, and inherent conclusion can be made regarding the other elements. There is no extra element in VDML metamodeling conformance which cannot be related to DIH, and some elements are abstract classes. As an example, Table 23. with information gathered through conceptual mapping between VDML and DIH concepts found in literature source #1 based on [19] and [25], will be displayed also here below.

Table 19. Conceptual Mapping VDML - DIH Literature Source #1.

VDML concepts	Lit source 1 [25]	Lit source 1 comments
<b>ValueDeliveryModel (7.2.3.1.1)</b>	<b>DIH Metamodel 1</b>	
<b>VdmlElement (7.2.4.1.1)</b>	<b>DIH Metamodel all elements</b>	Abstract class
<b>MeasurableElement (7.2.4.1.4)</b>	for example: number of companies, partners, research institutions...	
<b>Attributes (7.2.4.1.2)</b>	for example, specialization of DIH	
<b>Annotation (7.2.4.1.3)</b>	for example, region in which DIH operates	
<b>MeasuredCharacteristic (7.2.4.1.5)</b>	for example, size, strength, level of digitalization	
<b>PortContainer (7.2.4.3.4)</b>	<p>-Educating [25, p. 5] ,</p> <p>-As the source states: training, skill developing, business advising, helping with business plans, supporting scale-up and internationalization, matching new firms with customers, testing and validating, attracting funding for financing DIH activities [25, p. 18].</p> <p>-Inherent conclusion from the source: instructors, teachers, speakers, subject matter experts, matchmaking officer/broker, database, data lakes, coordinator, point of contact, liaison officer, engineers, funds, financial resources, advisors, researchers, mentors, teachers, coaches, consultants Micro- and small enterprises, Medium-sized enterprises, Mid-caps, large companies [25, p. 21].</p> <p>-As the source states: Regional cluster organizations, Cluster organizations from other regions, regional government, Chambers of commerce, Trade associations, Enterprise Europé Network (EEN) local..., Innovation support organizations, Incubators, Vocational training organizations, Funding organizations, National government, Investors [25, p. 31].</p> <p>-As the source states (Internal human capital): Internal skills (employed/affiliated), Universities within DIH consortium, Business actors within the DIH, Public actors within the DIH consortium, Business actors within the DIH consortium [25, p. 28].</p>	List all written under “Activities”, “Stores” and “Collaborations”

	-As the source states (external human capital): Other DIHs outside the region, Universities within the region (not part of DIH) Universities outside the region, Business actors within the region (not part of DIH), Business actors outside the region, Business actors within the region (not part of DIH, Public actors outside the region, Public actors within the region (not part of DIH), Other DIHs within the region, other DIHs outside the region [25, p. 28].	
<b>Collaboration (7.2.1.1.3)</b>	"Micro- and small enterprises, Medium-sized enterprises, Mid-caps, Large companies (DIH customers)" [25, p. 21]	
<b>Role (7.2.1.1.5)</b>	Investor [25, p. 24]	Investor is "Role", not "Collaboration"
<b>RoleDefinition (7.2.5.5.2)</b>	Investor invest resources into... Matchmaker (a person or a system) matches appropriate actors	
<b>RoleLibrary (7.2.5.5.1)</b>	Investor is a financial entity investing resources into... Matchmaker is an intermediary entity (a person or a system) matching appropriate actors	
<b>RoleCategory (7.2.5.5.3)</b>	financial entities intermediary entities	
<b>Participant (7.2.1.1.4)</b>	Author's own conclusion (in a DIH or project): Universities within DIH consortium, Business actors within the DIH, Public actors within the DIH consortium, Business actors within the DIH consortium; External human capital: Other DIHs outside the region [25, p. 28].	
<b>Actor (7.2.1.1.1)</b>	Author's own conclusion: in a DIH or project- platform for e-learning, project manager, communication officer, partners, library database, etc.	
<b>Person (7.2.1.1.2)</b>	Author's own conclusion: in a DIH or project- project manager (who is a specific person), communication officer (also a specific person), all the partners (all of them specific persons) etc.	
<b>Assignment (7.2.1.2.3)</b>	Author's own conclusion: in a DIH or project- meeting participation, webinar participation	
<b>OrgUnit (7.2.2.3.1)</b>	Author's own conclusion: in a DIH or project- Department, Testbed environments, Task force	
<b>Position (7.2.2.3.2)</b>	Author's own conclusion: in a DIH or project- department head, testbed head engineer, task force head	
<b>Community (7.2.2.2.1)</b>	"Micro- and small enterprises, Medium-sized enterprises, Mid-caps, large companies" [25, p. 21]	
<b>Member (7.2.2.2.2)</b>	Inherent conclusion "within DIH enterprise and company individual employees, especially the ones on executive positions making business decisions" [25, p. 21]	
<b>BusinessNetwork (7.2.2.1.1)</b>	-As the source states: Regional cluster organizations, Cluster organizations from other regions, Regional government, Chambers of commerce, Trade associations, Enterprise Europé Network (EEN) local (...), Innovation support organizations, Incubators, Vocational training organizations, Funding organizations, National government, Investors [25, p. 24]. -As the source states, external human capital is: Other DIHs outside the region, Universities within the region (not part of DIH) Universities outside the region, Business actors within the region (not part of DIH), Business actors outside the region, Business actors within the region (not part of DIH, Public actors outside the region, Public actors within the region (not part of DIH), Other DIHs within the region, Other DIHs outside the region [25, p. 28].	-BN is collaboration of "Party" [19, p. 14], -Community is collaboration of "Participants" [19, p. 45]
<b>Party (7.2.2.1.2)</b>	Inherent conclusion: regional clusters, Governments, Chambers of Commerce, Trade Associations, members of Enterprise Europé Network (EEN), Innovation support organizations, Incubators, vocational training organizations, funding organizations, Investors [25, p. 24]. -Inherent conclusion: "other DIHs, Universities not in DIH, Business actors not in DIH, Public actors not in DIH" [25, p. 28].	(i.e., legal advice provider, knowledge provider, technology provider, funding provider...)
<b>7.1.2 Value and Value Proposition</b>	TT [25, p. 2]	
<b>7.1.9 Activity</b>	educating [25, p. 5], internationalization [25, p. 18] -As the source states: training, skill developing, business advising, helping with business plans, supporting scale-up and internationalization, matching new firms with customers, testing and validating, attracting funding for financing DIH activities [25, p. 18].	Matching new firms with customers- is activity, and matchmaking is collaboration
<b>7.1.11 Resources and Stores</b>	Inherent conclusion: instructors, teachers, speakers, subject matter experts, matchmaking "officer"/broker, database, data lakes, coordinator, point of contact, liaison "officer", engineers, funds, financial resources, advisors, researchers, mentors, teachers, coaches, consultants	



However, there are elements of a DIH which did not fall into any of the (meta) classes defined in VDML metamodeling conformance. That can be seen from Fig. 67., depicting M1/2 Cognitive Level of DIH Model Representation, and also already in Fig. 27. Following the DIH story, the logic implied that it was necessary to add metaclasses “ValueandValueProposition”, “BusinessItem”, “Activity”, “Capabilities” and “CapabilityLibrary”.

“ValueandValueProposition” metaclass contains all the DIH value offerings, normally shown through DIH portfolio displayed on DIH web page. Examples of Values and Value Propositions discovered through the practical part of the research, are displayed in Table 20. below.

Table 20. Value and Value Proposition.

<b>Value and Value Proposition</b>	<b>Explanation</b>
<i>high technology experiments, giving the possibility of using experimental facilities</i>	-
<i>training or daily introduction of basic digital technology</i>	-
<i>supporting introduction of technology into business</i>	<i>It does not have to involve high tech, but analyzing the means of the company and supporting the introduction, customization and personalization of existing digital technology.</i>
<i>Digital transition</i>	<i>The European Industrial Strategy is based on green transition and digital transition pillars. DIHs work for Digital transition pillar, and it is a prerequisite for green transition.</i>
<i>helping businesses to become greener</i>	<i>Becoming green will soon become mandatory. DIHs should help define right digital technology to address green challenges.</i>
<i>Support, development of skills and companies, raising awareness related to digital skills and processes within a company, helping them develop internal processes, digital maturity, services and products</i>	<i>in order to raise digital components in products and services</i>
<i>TT, KT</i>	<i>There is some TT if technology is defined as a recipe for how to apply something and have it returned through licensed product, but it is not the focus. They only provide</i>

	<p>support for customers to start their journey in that direction and go a step further from where they originally were.</p> <p>Some state that it is not TT, that they have an approach of consulting organization which help someone to apply already developed technology.</p>
<i>mutual trust</i>	<i>created through networking</i>
<i>regional growth</i>	<i>Some DIHs are more tending to regional development and to broader lifting of more basic digital skills, and the others are more related to high-end skills.</i>
<i>awareness that a DIH is needed for digitalization, for the improvement of the economy through digital technology, work and life in general</i>	<i>in order to create motivation for the DIH model to succeed in real life</i>
<i>consulting on how to apply certain technologies in its business, test certain technologies for developing some other digital product or</i>	<i>service, provide help in developing EDTs with some digital innovation or to test of digitalization of some part of process.</i>
<i>help with application of existing technologies</i>	<i>The next step is to know where the potential suppliers are in order to proceed with public procurement and start implementing that technology</i>
<i>consulting and education</i>	<i>training, competence enhancing, consulting for application</i>
<i>strategic partnerships built with important companies, users and public institutions.</i>	<i>Even a small improvement with public administration is a huge societal impact.</i>
<i>increasing digital maturity of companies</i>	-
<i>delivering impact on the companies</i>	-
<i>making the next step with digitalization in Europe, most of all with AI, through providing help to more traditional and smaller companies which are lagging behind in that regard but have some AI experience, which will hopefully start a domino effect to get the other ones on board.</i>	<i>The ones who are not at all looking at AI are not being considered.</i>
<i>demonstration activities</i>	<i>DIH will demonstrate some technologies with KT possibilities and raising awareness about DIHs</i>
<i>facilitating, as well as skills</i>	-
<i>business plans, access towards difficult to reach lobbies and first customers, lobbying towards local governments, and building s benchmark</i>	<i>in healthcare, if they pass screening from the national authority, then the process gets easier</i>
<i>cooperation with public administration</i>	-

<i>DT</i>	-
<i>Knowledge in terms of one-to-one service with experts adjusted to their needs is also the value they offer.</i>	<i>One of the DIHs emphasized that they are applied, and when they do science they firstly make a project which someone is willing to pay for and then make a scientific article. They do more industrial research, have many mentors with rich business experience, can do a quick triage to see if market can be created for the idea, and can provide infrastructure.</i>
<i>networking and personalized</i>	-
<i>best practice</i>	-
<i>access to testing, education, training, and finance</i>	-
<i>increasing digital maturity of companies and delivering impact on the companies</i>	-
<i>trying to catalyze DT of companies</i>	-
<i>optimization from business perspective and trying to help customers from a wider value perspective</i>	-
<i>to increase prosperity in general</i>	<i>by successful DT, with strong focus on KT</i>
<i>community building services, test before invest services like digitalization pathways, testing and feasibility assessment, smart they consider them all to be TT and KT services/elements devices data technology demonstrations and advanced AI services like cyber security, design thinking, design technology solutions, skills development services, knowledge training sessions on the job, advance training course on technology and soft skills, editing adoption, last pillar is support services (financing, funding, scouting for deployment of digital solutions and accelerating and mentoring in digital areas.</i>	

“BusinessItem” metaclass contains all that the DIH can offer as a solution to the client, who comes asking for help. Many of those solutions overlap with what interviewees were answering when asked about DIH activities, which comes down to services they provide. Information gathered regarding the content of “BusinessItem” metaclass is displayed in Table 21. below.

Table 21. Business Items.

<b>Business Item</b>	<b>Explanation</b>
<i>test before invest</i>	<i>involves creation of prototype, very fast prototyping, companies get knowhow and understanding, sometimes involves sandboxes</i>
<i>AI, cyber security to setting up firewall (expertise and skills)</i>	<i>DIHs help from DEP is available in the area</i>
<i>finding finances and support for investing (investors)</i>	<i>what are the possibilities of funding</i>
<i>building line of journey from proof of concept to certification</i>	<i>digitalization strategy development</i>
<i>allowing access to various researchers with competences</i>	<i>matchmaking, speedates between students and startups/organizations; matchmaking trough organizations, finding potential employees amongst graduates and students</i>
<i>building business plan, creating strategic intelligence reports</i>	-
<i>building competences</i>	<i>consulting and competence enhancing</i>
<i>using labs from different universities, supercomputers, digital equipment</i>	<i>use of many different test beds/ kinds of test environments, and assistance for using them; industrial workspace</i>
<i>providing advice on legal issues, as well as venture building</i>	<i>helping start-ups through education and finding access to funds</i>
<i>knowledge tailor made</i>	<i>for a specific audience, customized education with professors</i>
<i>incubation</i>	<i>Support to SMEs to become ready to start, finding financing, getting the necessary education and facilities</i>
<i>bootcamps</i>	<i>for preparation of companies for transformation from “I want to be digitalized” to “I have the basic project for digitalization”</i>
<i>finding markets</i>	-
<i>creation of use- cases</i>	
<i>reskilling and up-skilling</i>	-
<i>raising awareness about digitalization possibilities</i>	<i>workshops on what is on the market and what is available to the companies</i>
<i>assistance during events</i>	<i>on which companies are trying to impress investors (venture capital investment)</i>
<i>vouchers and services for digitalization</i>	-
<i>tools</i>	<i>developed to help the customer, TV talk show about digitalization</i>

<i>possibility to do master's thesis for free</i>	<i>for a company which needs it at one of partner universities</i>
---	--

“Capabilities” and “Capability Library” metaclasses were also added to DIH metamodel. They contain what was clustered under “Skills” and “Testbed/Equipment” class in M1/1 DIH VDML Model representation. Many of those Capabilities summed up in Capability Library overlap with what interviewees were answering when asked about DIH resources. Information gathered regarding the content of “Capabilities” metaclass is displayed in Table 22. below.

Table 22. Capability.

<b>Capability</b>	<b>Explanation</b>
<i>competent people (human resources) with different expertise</i>	<i>who understand the needs of their working area, can translate them into opportunities for digital technology, possess knowledge and know-how of research institutions or specialized companies, and can help SMEs and public administration introduce those digital technologies into day-to-day business</i>
<i>testbeds/equipment, university labs, using competence center and center of excellence labs (also E-lab, Smart Lab), robotic centers</i>	<i>test beds and test environments with access to hardware, adequate testing and experimentation facilities, on their own location but also university labs and from other entities</i>
<i>skills</i>	<i>efficient and highly qualified staff specialized in advanced tech, which should provide advice and perform testing of specific advanced technology, which should provide advice and perform testing of specific advanced technology the staff should be able to tell how customers would for example use AI or block chain, and show how customers would benefit from that technology</i>
<i>Reach out for technology</i>	<i>In case DIH doesn't possess it, it should be connected to other DIHs</i>
<i>university employees' engagement through outsourcing (professors), solutions through networking with different stakeholders</i>	<i>that makes networking also a kind of a resource.</i>
<i>DIH's own academy</i>	<i>which will encompass different scientific fields and transfer knowledge tailor made for a specific audience</i>
<i>catalogue of experts</i>	<i>all kinds of expertise coming from experts from the government level policy makers, and business arena; networking through cluster industry forum</i>
<i>TV talk show about digitalization</i>	<i>digital health check, digital maturity assessment</i>

<i>digitalization of aftersales processes</i>	-
<i>virtualization of customer experience, advanced logistics lab, car mechanic of the future lab, AI express...</i>	<i>for example, in car selling point of sales, aftersales services, and virtualization of electric car mechanic garage where they train people in their virtual environments to get skills in repairing electric cars</i>
<i>municipalities</i>	<i>many complementary resources, existing communication channels, different HUBs with their ecosystems, universities in close relations with business in region to help with functions of DIH core business</i>
<i>facilities which a company can visit and explore how these things work</i>	<i>it is hard to show the benefits of digitalization only through computers</i>

### 7.5. Main Objective No5

The fifth main objective is: (5) The design of DIH RMM.

Subchapter 5.2. explains the logic behind design of DIH VDML metamodel, as a model of DIH value creation, which includes all the novel information gathered through practical part of the research, in different Variants of DIH VDML models. VDML metamodel is to be extended with other referent architectures. Chapter 4. and 5. explain the logic behind constructing models composed of DIH concepts mapped onto VDML concepts, which were mapped onto different referent architectures concepts, all pertaining to different views of a DIH. The design of DIH RMM is an assembly of DIH VDML metamodels (Fig. 85.-90.) and also all the models of a DIH created through the use of different referent architectures.

### 7.6. Main Hypothesis No1

H1: In accordance with relevant theories of value delivery, Digital Innovation Hub is a Value Delivery System.

For H1 to be accepted, the necessary condition is that with conceptual mapping, all VDML concepts from metamodeling conformance can be found in different programs, policies, and other documents which define DIH, such as DIH expert literature. As was already stated, all those concepts were identified in DIH related literature.

Following that, VDML metamodel was extended with other referent architectures described in chapter 5, whose concepts are mapped onto VDML/DIH elements. Afterwards, a discussion regarding which concepts were mapped, and which were not followed.

In addition to that, Table 12 sums up information gathered during the practical part of the research, i.e., answers from interviewees when asked about DIH Value and Value Proposition. The numerous and extensive answers they gave shows that they recognize DIH as a VDS, and had many arguments in support of that claim.

H1 is accepted.

## 7.7. Main Hypothesis No2

H2: Digital Innovation Hub Referent Meta-Metamodel is an adequate instrument for determining conformance of referent architectures which contain concepts of Value Delivery.

H2 was to be proven through in-depth interview, and the use of developed artefacts. H2 is to be accepted if more than 80% of interviewees in the first part of interviewing process can recognize concepts from real world and can map between M0 and M1/1 conceptual levels.

H2 is accepted.

## 7.8. Chapter Conclusions

The research was conducted in five phases, following the phases of DSR framework. This chapter elaborates upon phase five; objectives and hypotheses of this thesis.

Regarding Main Objective No1, the factors influencing DIHs and EDIHs as intermediaries in this thesis are derived from mostly expert literature. Scientific literature recognizes many problems with intermediaries in KT processes from research community to industry and vice versa. Those problems are also factors influencing intermediaries. Researching the scientific literature on KT and TT from research community to industry and vice versa, it becomes obvious that there are some general topics that appear. Those topics are added to the list of factors influencing intermediaries. Finally, throughout the practical part of the research, some additional factors were drawn regarding factors which impact DIHs and EDIHs as intermediaries.

Speaking about Main Objective No2, there are numerous intermediaries mentioned in scientific and expert literature regarding KT and TT from research community to industry and vice versa, all with similar missions which include bringing different stakeholders together in some number of helices. On the other hand, there are also DIHs and EDIHs, as intermediaries in processes of KT and TT from research community to industry and vice versa. Their functions are somewhat different. In essence, DIH and EDIH one-stop-shops are under EU's initiative, unique entities throughout the whole Europe, aligned with S3, focused on the issues of DT and on SMEs, are non-profit, bridge between different knowledge institutions, gather different stakeholders and network them in their ecosystem. EDIHs' functions overlap with DIHs', they have a cross-border aspect, focus also on public administration, and since they receive 50% of the funding from EC they also have a larger mandate, bigger responsibility, and direction given through EC's KPIs.

As for Main Objective No3, four different variants of M0 DIH VDML representations and four different variants of M1/1 DIH VDML representations were created and displayed.

Main Objective No4 elaborates upon establishing the degree of conformance of DIH with VDML metamodel. It is important to stress that there are elements of a DIH which did not fall into any of the (meta) classes defined in VDML metamodeling conformance. The logic implied



that it was necessary to add metaclasses “ValueandValueProposition”, “BusinessItem”, “Activity”, “Capabilities” and “CapabilityLibrary”.

The design of DIH RMM falls under the Main Objective No5. The design of DIH RMM is an assembly of DIH VDML models and also all the models of different DIH views created through the use of different referent architectures.

Both Main Hypotheses were accepted.

All participants of a focus group agreed with DIH RMM design logic and also with main conclusions of the thesis. The list of claims pertaining to the versions regarding weather a DIH should have out of region participants and what would be internal to a DIH show that all variants of M1/1 DIH VDML should be kept.

## 8. CONCLUSIONS

The value of this research regarding KT from research community to industry, is in the fact that no similar research has been conducted with DIHs in focus. The research provides insight regarding DIHs as intermediaries in the process of KT from research community to industry and vice versa. Being able to help companies of all sizes digitalize their businesses with the wide spectrum of services they are able to provide, DIHs play an important role in DT of EU. Having support for SMEs in focus, they are important actors helping EU become more competitive on global market.

### 8.1. UML, VDML and MOF

OMG proposals and specifications can be used for creation of DIH RMM. DIHs are structures related to DT and its added value can be mapped onto a VDML metamodel, so that its suitability for DIH RMM be explored. That knowledge can be used for DIH benchmarking, for comparison of different DIHs, and as information system architecture blueprint for design.

UML Model was used to represent the Object of Modeling, which is conformant with UML Metamodel. UML Metamodel is conformant with MOF. DIH system was an object of modeling. DIH System, represented as a DIH model was depicted as a UML model, and it is conformant with DIH RMM. VDML profile was used for metamodeling extension. Object of Modeling was then a VDS, so UML profiled model is VDSM, which is conformant with VDML. VDML Collaboration Modeling Conformance was used for conformance analysis, and each concept was found DIH documents selected for the research. Conceptual mapping was performed and mapped concepts were displayed in a table. Findings of this research prove that the design DIH RMM is possible

## 8.2. Contributions

The following are the scientific contributions of this research:

- a) The methodology and RMM DIH as a value-producing system [40], and
- b) The scientifically established facts regarding KT between research community and industry, as well as increased knowledge regarding DIHs.

Contribution to Information and Communication Sciences is contained in the very essence of a DIH, as an organizational unit acting as a KT catalyst, with technology in its background, and addressing issues of digitalization.

Proposed VDML DIH RMM practical use as conceptual framework for modeling of DIHs, is the societal contribution. The value of this research lies in synergy enhancement between different sectors, and contribution to empowerment of national and European economy.

## 8.3. Scientific Foundation

The scientific foundation of this thesis is in KT and TT from research community to industry and vice versa. Scientific literature review was conducted accordingly. Some basic elements associated with it in scientific literature are: network cohesion, range, size, proximity, boundary spanners, clusters and broader set of knowledge resources. Social capital discussion takes an important part of KT scientific literature, elements of which are: scientist seniority, cultural differences, autonomy, cross-boundary relationships, academic entrepreneurs,

entrepreneurial academics, and finally cognitive and relational social capital. Discussion regarding TH and QH, which are concepts often found in scientific literature, explains the interconnection of different stakeholders in processes of KT, which have an immense impact on the synergy. Discussion on patenting gives some explanation on reoccurring themes: absorptive capacity, commercialization and ownership are. The most important elements which seem to appear in literature, and which were not mentioned so far are: KT channels, academic consulting, KT activities, knowledge enablers, occupational boundaries, boundary spanners, engaging external engineers, barriers, innovations, collaboration choices, human mobility, highly skilled professions and funding.

There are many different kinds of intermediaries in KT processes, and there are about 50 recognized problems of intermediaries in the processes of KT from research community to industry, which can be clustered in three groups. The focus of this thesis further narrows down to DIHs, which are a special kind of intermediaries in the KT processes from research community to industry and vice versa. These one-stop-shops focusing on DT of mostly SMEs and mid-caps are the main protagonists of this thesis. It is evident from the information provided regarding EDIHs, that EDIHs' and DIH's definitions and the definitions of service they provide overlap. EDIHs are special kinds of DIHs.

In this research, TT will be considered a subset of KT, as it is a narrower concept. Literature review regarding TT from research community to industry and vice versa was conducted. Commercialization is an important element of TT. The terms which appear the most in scientific literature related to TT are different activities and also collaborations, technological KT, different Acts which allow licenses, patents and inventions, as well as economic growth. Funding is paramount for TT to come to realization. The terms which appear in scientific literature regarding funding in relation to TT besides investment strategies are FDI, research funded by the industry, expenditure for research and development, private funding, and investment in innovating. Innovation is an inseparable element of TT. Many scientific articles are written on this topic, and mention different institutionalized innovation activities, government sponsored programs, open innovation networks, regional innovation level, innovative strategic model, effects on sustainable growth and innovation landscape.

Intermediaries in TT processes are important entities performing different activities, there are various different ones, just like there are different ones in KT processes. Scientific literature mentions quite a number of them. Scientific literature mentions also different business models regarding TT focusing on different TT aspects: NtK Model, American and European Models, The Sustainable Innovative Academic Entrepreneurship Process Model, TH Model, Open Innovation Models, Free Agency Model, UTTBM, “Intra-China”, “Foreign Nation–China” and “China–Foreign Nation”, Subcontracted Innovation Model, Cooperative Innovation Model (Consortia-Based Innovation Model), Open Community Innovation Model and different quantitative TT models. Patents are an integral part of TT processes. Scientific literature mentions different issues related to that topic like: reasons for not asking for patent protection, protection, IP ownership, TT channel, university patents, patent analysis and imitation. Policies are an important element in TT processes which should be given well deserved attention. Scientific literature mentions a number of different ones like IP policy, spin-off policies, start-up strategies, faculty and staff incentives and also issues like TT policy creation, conflict of interest, and COP. Social factors are an important element of TT processes also; articles on the topic of social factors in TT processes address the following issues: mention enterprising norms, previous experience, mobility, culture, academic engagement, gender issues and personal values, goals and predispositions. Scientific literature mentions spin-offs and start-ups in articles related to TT, and elements associated to them which appear are related to university incubators, which elements they have positive correlation with, USUI, issues related to different work speeds and interdisciplinarity. In scientific literature, UI collaboration is mentioned in context of IUCRCs, UI projects, Collaborative research and teaching- focused activities. Some other matters related to TT processes also mentioned in scientific literature, which can't be fitted in any of the before mentioned thematic categories are the following: absorptive capacity, degree of openness, risk assessment, TT barriers, Industry 4.0, Internationally oriented companies, geographical proximity, TT strategies and clusters.

#### 8.4. Value and Value Delivery

One of the hypothesis of this entire research is that the business model of a DIH in its essence is a model of a value delivery system. The value needs to be represented adequately, and that

can be achieved through modeling, metamodeling, ontologies, different methods, methodologies, languages and tools. Definitions of basic concepts necessary for value representation; definitions of modeling, metamodeling and ontologies were given.

In the domain of value delivery, this thesis is not dealing with cataloguing its elements, but rather with representing DIH, a part of that domain. For DIH, models and a metamodel will be built, and the closed world assumption will restrict their arbitrary extensions. In that process, artefacts will be specified and RMM will be prescriptive, meaning that it will show what all a DIH has to be composed of in order to be called a DIH. DIH RMM could be used in future for the design of DIH information systems. All the above-mentioned arguments go in support of the decision to use metamodeling for DIH RMM design.

It is evident that value can take many different forms in terms of benefits of all sorts for a company or a customer. One of those benefits can also be knowledge. Overview of the following value methods and methodologies were given: Value-Driven Development Method, e3value Method and Systemic Enterprise Architecture Methodology. Value ontologies, even though they were not chosen as a method for this thesis, were given some attention as well. Those value ontologies are: REA ontology, OeBTO, AIAI EO, TOVE, BMO, BMC and e-Business Model Ontology. Some other matters which did not fall in any of the previously mentioned categories are mentioned also, and they are: value-based requirements engineering, DVD, i\* 2.0, CVN, e-Value Network Management models, EuGENia tool, Bee-Up, UML and VDML.

DIH's business model was analyzed with VDML. In order to depict DIH model, Visual Paradigm tool was considered adequate. M0, M1/1 and M1/2 cognitive level of DIH Model representations were created through concept mapping. It is possible to map VDML concepts onto BMC concepts, even though some BMC elements partially map onto VDML, some do not map onto any particular VDML element but it is possible to inherently find those concepts in DIH literature which do not map onto anything.

Osterwalder's BMC Model enriched with some additional exemplary members which can be related to DIH can be created, as well as a Osterwalder's BMC Metamodel. Mapping VDML DIH concepts onto VNA can be done. Therefore, it is possible to create a VNA model as well. Regarding TOGAF, five examples of DIH value streams were displayed, which was possible to create following the methodology which describes value streams, creates storyline description, graphically and in table explains stages of a value stream, conducts cross-mapping between necessary business capabilities from capability map and links them to stages in value stream, creates a model of a value stream, and finally creates a DIH Value Stream Metamodel based on those five exemplary models. VDML DIH concepts are possible to map onto REA ontology, as well as to create REA model and a metamodel. Mapping of VDML DIH concepts onto e3value can also be done. e3value model and metamodel are possible to create, and it is possible to map VDML concepts onto e3value concepts. VDML concept mapping onto BMC concepts is possible; it is possible to directly map 10 VDML concepts onto BMC concepts and even though some 2 BMC elements concepts can partially map onto VDML concepts. Some. Two BMC concepts do not map onto any particular VDML element concept, but it is possible to inherently find those concepts in DIH literature and only one BMC concept does not map onto anything. Osterwalder's BMC Model enriched with some additional exemplary members relatable to DIH is possible to create, and so is Osterwalder's BMC Metamodel. VDML concept mapping onto Lindgren's Business BMC is also possible. The final conclusion is that mapping between VDML and other referent architectures is possible.

## 8.5. Design Science Research Framework

DSR was deemed the best approach for this thesis was given. Other scientific methods which were used are: scientific and expert literature review, conceptual mapping, (meta)modeling; mapping onto other methodologies, in-depth interview, and a focus group. The entire research was conducted in five phases, following the phases of design science research framework. In the First Phase, qualitative research has been conducted through literature review, which enabled wider research context. In the second DSR phase, the proposed DIH- UML-MOF methodology and VDML profile extended metamodeling is explained, as a part of DIH RMM

creation methodology. Conformance Analysis was conducted at VDML Collaboration Modeling Conformance level. The Second Phase, focuses on the hypothesis claiming that the business model of a DIH is in its essence a delivery of value. In the third phase, artifacts were created. Conceptual mapping was conducted in a way that each of these before mentioned VDML related to DIH RMM creation methodology concepts was recognized in DIH documents selected for this research, in order to conduct conformance analysis. Instruments for the qualitative semi-structured in-depth interviews were designed. There were no legal and ethical considerations to be taken into account. No vulnerable or under aged social groups were interviewed, and interviewing was conducted with signed consent. Also, questions asked were not of delicate nature and in no way related to ethical matters. In this thesis, metamodeling with UML is also conceptual mapping, but vice versa does not apply. The reason why conceptual mapping is not also metamodeling is that focus of conceptual mapping is visualization of knowledge and concepts, whilst metamodeling focuses on defining structures and semantics of models and systems. Fourth Phase was conducted through verification and validation. Qualitative in-depth interview was conducted, in order to collect the information from DIH experts and satisfy the verification process. Two interviewing sessions were conducted; firstly, with DIH experts from EC and national authorities, and then also with experts from different DIHs. Selected DIH cases from DIH expert literature chosen for DIH RMM design were deemed suitable, as well as the referent architectures put in DIH context. Also, initial DIH model and metamodel were verified, and attention was given to missing, unnecessary or incorrect DIH RMM artifacts/elements, which provided basis for adjustment of DIH RMM. The interviewees were able to recognize real world concepts and do mapping between M0 and M1 conceptual levels. Also, much information was gained regarding EDIHs.

Following VDML DIH metamodel verification, DIH RMM was validated by focus group. All participants agree with DIH RMM design logic and how it is related to the practical examples displayed, and also with main conclusions of the thesis. The list of claims pertaining to the versions regarding weather a DIH should have out of region participants and what would be internal to a DIH show that all variants of M1/1 DIH VDML should be kept.

## 8.6. Research Objectives and Hypotheses Revisited

Regarding Main Objective No1, the factors influencing DIHs and EDIHs as intermediaries in this thesis are derived from mostly expert literature. Scientific literature recognizes many problems with intermediaries in KT processes from research community to industry and vice versa. Those problems are also factors influencing intermediaries. Researching the scientific literature on KT and TT from research community to industry and vice versa, it becomes obvious that there are some general topics that appear. Those topics are added to the list of factors influencing intermediaries. Finally, throughout the practical part of the research, some additional issues were collected, which impact DIHs and EDIHs as intermediaries.

In regards to Main Objective No2, it is important to mention that there are numerous intermediaries mentioned in scientific and expert literature regarding KT and TT from research community to industry and vice versa, all with similar missions which include bringing different stakeholders together in some number of helices. On the other hand, there are also DIHs and EDIHs, as intermediaries in processes of KT and TT from research community to industry and vice versa. Their functions are somewhat different. In essence, DIH and EDIH one-stop-shops are under EU's initiative, they are unique entities throughout the whole Europe, aligned with S3, focused on the issues of DT and on SMEs, are non-profit, bridge between different knowledge institutions, gather different stakeholders and network them in their ecosystem. EDIHs' functions overlap with DIHs', they have a cross-border aspect, focus also on public administration, and since they receive 50% of the funding from EC they also have a larger mandate, bigger responsibility, and direction given through EC's KPIs.

As for Main Objective No3, four different variants of M0 DIH VDML representations and four different variants of M1/1 DIH VDML representations were created accordingly and displayed. All those four different variants together create DIH RMM, which is a part of Main Objective No5.



Main Objective No4 elaborates upon establishing the degree of conformance of DIH with VDML metamodel. It is important to stress that there are elements of a DIH which did not fall into any of the (meta) classes defined in VDML metamodeling conformance. The logic implied that it was necessary to add metaclasses “ValueandValueProposition”, “BusinessItem”, “Activity”, “Capabilities” and “CapabilityLibrary”.

Both Main Hypotheses were accepted.

The design of DIH RMM falls under the Main Objective No5. The design of DIH RMM is an assembly of DIH VDML models (variants) and also all different DIH views created through the use of different referent architectures.

All participants agree with DIH RMM design logic and also with main conclusions of the thesis. The list of claims pertaining to the versions regarding weather a DIH should have out of region participants and what would be internal to a DIH show that all variants of M1/1 DIH VDML should be kept.

## 8.7. Limitations and Further Study Suggestions

The limitations of this study pertain to time and available personnel for interviewing. The biggest limitation of this thesis’ research is the time, availability (small sample) and motivation of the appropriate interviewees, and also the available DIH literature.

Further study suggests more DIH literature sources to be exploited for conceptual mapping. Further study suggestion is the comprehensive study of all the existing DIHs, DIH concepts mapping onto VDML metamodel and DIH RMM proposal design, which could be utilized for comparing of DIHs, benchmarking, for enhancing interoperability between DIHs, and also for structuring of the DIH catalogue.

Further research could be conducted through the subjects such as: development of DIH and EDIH network model, impact of quantum computing and quantum communications on DIHs and EDIHs, DIH and EDIH alignment with S3 strategies, support of the state politics oriented towards DIHs and EDIHs, DIH RMM elaboration through ontologies (not metamodeling) or a combination of metamodeling and ontologies, and the creation of AI for the DIH/EDIH catalogue.

## 9. REFERENCES

- [1] P. Kivimaa, W. Boonc and S. Hyysalod, "Towards a typology of intermediaries in sustainability transitions: A," *Research Policy*, vol. 48, no. 4, pp. 1062-1075, 2019.
- [2] W. Klomklieng, P. Ratanapanee, S. Tanchareon and K. Meesap, "Strengthening a Research Cooperation Using a Triple Helix Model: Case Study of Poultry Industry in Thailand," *Procedia - Social and Behavioral Sciences*, vol. 52, p. 120 – 129, 2012.
- [3] O. Al-Tabbaa and S. Ankrah, "Social capital to facilitate 'engineered' university-industry collaboration for technology transfer: A dynamic perspective," *Technological Forecasting & Social Change*, vol. 104, pp. 1-15, 2016.
- [4] I. Martín-Rubio and D. Andina , "University Knowledge Transfer Offices and Social Responsibility," *Administrative Sciences* , vol. 6, no. 4, pp. 1-19, 2016.
- [5] A. Sengupta and A. S. Ray, "Choice of Structure, Business Model and Portfolio: Organizational Models of Knowledge Transfer Offices in British Universities," *British Journal of Management*, vol. 00, p. 1–24 , 2017.
- [6] E. Commision, "Pillars of the Digitising European Industry initiative," European Commission, 20 June 2018. [Online]. Available: <https://ec.europa.eu/digital-single-market/en/pillars-digitising-european-industry-initiative>. [Accessed 23 5 2020].
- [7] M. Jurčić and V. Strahonja, "Conceptual Analysis of the Digital Innovation Hub as a," in *Central European Conference on Information and Intelligent Systems*, Varaždin, 2020.
- [8] E. Commision, "Digital Innovation Hubs in Digital Europe\_background document December 2018," European Commision, Bruxelles, 2018.
- [9] E. Commission, "Entrepreneurship and Small and medium-sized enterprises (SMEs)," European Commission, n.d.. [Online]. Available: [https://ec.europa.eu/growth/smes\\_en](https://ec.europa.eu/growth/smes_en). [Accessed 11 Jun 2020].
- [10] E. Commision, "Reports and studies," European Commission, 2019. [Online]. Available: <https://ec.europa.eu/digital-single-market/en/reports-and-studies/76256/76256>. [Accessed 17 11 2020].
- [11] R. Virkkunen, K. Still and L. Rosso, "Digital Innovation Hubs in Finland," Ministry of Economic Affairs and Employment, Helsinki, 2019.
- [12] OMG, "VDML," OMG, 3 2018. [Online]. Available: <https://www.omg.org/spec/VDML/About-VDML/>. [Accessed 17 11 2020].

- [13] G. Poels , B. Roelens , H. de Man and T. van Donge, "Continuous business model planning with the value management platform," in *12th International Workshop on Value Modeling and Business Ontologies*, Amsterdam, 2018.
- [14] R. Wieringa, J. Gordijn and D. Ionita, "Tool Support for Value Modeling and Risk Analysis of e-Services," in *24th Joint International Conference on Requirements Engineering*, Utrecht, Netherlands, 2018.
- [15] J. Gordijn and H. Akkermans, "Value-based Requirements Engineering: Exploring Innovative e-commerce Idea," *Requirements Engineering Journal*, vol. 8, no. 2, pp. 114-134, 2003.
- [16] B. M. Toolbox, "www.bmtoolbox.net," Business Model Toolbox, 2021. [Online]. Available: <https://bmtoolbox.net/tools/business-model-canvas/>. [Accessed 11 11 2021].
- [17] T. O. Group, "www.opengroup.org/togaf," The Open Group, 2021. [Online]. Available: <https://www.opengroup.org/togaf>. [Accessed 1 11 2021].
- [18] P. Lindgren and O. H. Rasmussen, "The Business Model Cube," *Journal of Multi Business Model Innovation and Technology*, vol. 1, no. 3, pp. 135-180, 2013.
- [19] OMG, "Value Delivery Modeling Language (VDML)," October 2018. [Online]. Available: <https://www.omg.org/spec/VDML/>.
- [20] P. Nowotarski and J. Paslawski , "Industry 4.0 Concept Introduction into Construction SMEs," in *World Multidisciplinary Civil Engineering-Architecture-Urban Planning Symposium: WMCAUS 2017* , Prague, Czech Republic, 2017.
- [21] J. Preester, P. Jung Erceg and I. Kumić, "Barriers to the Implementation of Key Enabling Technologies," *Tehnički glasnik*, vol. 10, no. 3-4, 2016.
- [22] D. N. R. N. Resende, D. G. Gibson and J. Jarret, "BTP—Best Transfer Practices. A tool for qualitative analysis of tech-transfer," *Technovation*, vol. 33, no. 1, pp. 2-12, 2013.
- [23] E. Commision, "Reports and studies," 2019. [Online]. Available: <https://ec.europa.eu/digital-single-market/en/reports-and-studies/76256/76256>.
- [24] C. E. Lantz and K. Wu, "Building and managing an innovation hub: A case study of the challenges and opportunities faced by," 2017. [Online]. Available: <https://www.semanticscholar.org/paper/Building-and-managing-an-innovation-hub-%3A-A-case-of-Wu-Lantz/af0732e82d1f2c67b676fc054c88a009f0790dea>.
- [25] J. Miörner, G. Rissola, J. Sörvik and J. Wernberg, "Putting Digital Innovation Hubs into Regional Context," Publications Office of the European Union, Luxemburg, 2019.
- [26] D. W. G. 1, "Digital Innovation Hubs: Mainstreaming Digital Innovation Across All Sectors," European Commision, 2017.

- [27] E. Comission, "Science, Research and Innovation Performance of the EU 2020," European Comission, Bruxelles, 2020.
- [28] J. Akoka, I. Comyn-Wattiau, N. Prat and V. C. Storey, "Knowledge Contributions in Design Science Research: Paths of Knowledge Types," *Decision Support Systems*, 2022.
- [29] M. Huseynli, U. Bub and M. C. Ogbuachi , "Development of a Method for the Engineering of Digital Innovation Using Design Science Research," *Information*, vol. 13, no. 573, pp. 2-25, 2022.
- [30] A. Hevner, S. Chatterjee and A. Maedche, "Introduction to Design Science Research," *Design Science Research. Cases*, vol. 22, pp. 1-13, 2020.
- [31] A. R. Hevner, S. T. March, J. Park and S. Ram, "Design Science in Information Systems Research," *MIS Quarterly*, vol. 28, no. 1, pp. 75-105, 2004.
- [32] R. Winter and J. v. B. vom Brocke, "Teaching Design Science Research," in *Forty-Second International Conference on Information Systems*, Austin, 2021.
- [33] A. H. Hevner and S. Chatterjee, "Design Science Research Frameworks," *Design Research in Information Systems* , vol. 22, pp. 23-31, 2010.
- [34] G.-J. Ji, "Value Delivery Systems under the Instantaneous," *Journal of Service Science and Management*, vol. 1, pp. 29-49, 2008.
- [35] OMG, "ABOUT THE VALUE DELIVERY MODELING LANGUAGE SPECIFICATION VERSION 1.1," OMG, 2021. [Online]. Available: <https://www.omg.org/spec/VDML/>. [Accessed 3 12 2021].
- [36] OMG, "Value Delivery Modeling Language (VDML);," [Online]. Available: <https://www.omg.org/intro/VDML.pdf>. [Accessed 3 12 2021].
- [37] B. Roelens and G. Poels, "Towards a Strategy-Oriented Value Modeling Language: Identifying Strategic Elements of the VDML Meta-model (ER 2013)," in *International Conference on Conceptual Modeling*, Hong Kong, China, 2013.
- [38] OMG, "METAOBJECT FACILITY," [Online]. Available: <https://www.omg.org/mof/>. [Accessed 3 12 2021].
- [39] OMG, "MOF," OMG, n.d.. [Online]. Available: <https://www.omg.org/mof/>. [Accessed 17 11 2020].
- [40] M. Jurčić and V. Strahonbja, "Conceptual Analysis of the Digital Innovation Hub as a Value Delivery System," in *Proceedings of the Central European Conference on Information and Intelligent Systems, CECIIS 2020*, Varaždin, Hrvatska, 2020.
- [41] J. Verrue, "A critical investigation of the Osterwalder business model canvas: an in-depth case study," in *Belgian Entrepreneurship Research Day, Proceedings*, Ghent, 2014.

- [42] W. M. Trochim and D. McLinden, "Introduction to a special issue on concept mapping," *Evaluation and Program Planning*, vol. 20, pp. 166-175, 2017.
- [43] J. D. Novak and A. J. Cañas, "The Theory Underlying Concept Maps, Technical Report IHMC CmapTools 2006-01,," Florida Institute for Human and , Pensacola, Florida, 2006.
- [44] J. V. Y. Yin, M. Tomita and . M. Araceli Ruiz-Primo, "Using Concept Maps in the Science Classroom," *Science Scope*, vol. 28, no. 8, pp. 27-31, 2005.
- [45] A. J. Canas, J. W. Coffey, M. J. Carnot, A. Feltovich, R. R. Hoffman, J. Feltovich and J. D. Novak, *A Summary of Literature Pertaining to the Use of Concept Mapping Techniques*, Pensacola, Florida, 2003.
- [46] M. Felderer and A. Beer, "Mutual knowledge transfer between industry and academia," in *Software Engineering & Management* , Dresden, Germany, 2015.
- [47] E. de Wit-de Vries, W. A. Dolfsma, H. J. van der Windt and M. P. Gerkema, "Knowledge transfer in university–industry research," *Journal of Technology Transfer*, vol. 44, p. 1236–1255, 2019.
- [48] J. Yu, B. A. Gilbert and B. M. Oviat, "Effects of alliances, time, and network cohesion on the initiation of foreign sales by new ventures," *Strategic Management Journal*, vol. 32, no. 4, p. 424–446, 2011.
- [49] J. W. SPENCER, "FIRMS' KNOWLEDGE-SHARING STRATEGIES IN THE GLOBAL INNOVATION SYSTEM: EMPIRICAL EVIDENCE FROM THE FLAT PANEL DISPLAY INDUSTRY," *Strategic Management Journal*, vol. 24, p. 217–233, 2003.
- [50] M. S. Roth, S. Jayachandran, M. Dakhli and D. A. Colton, "Subsidiary Use of Foreign Marketing Knowledge," *Journal of International Marketing*, vol. 17, no. 1, p. 1–29, 2009.
- [51] H. Jiang, J. Xia, A. A. Cannella and T. Xiao, "Do Ongoing Networks Block Out New Friends? Reconciling The Embeddedness Constraint Dilemma on New Alliance Partner Addition," *Strategic Management Journal*, vol. 39, no. 1, pp. 217-241, 2017.
- [52] R. Reagans and B. McEvily, "Network Structure and Knowledge Transfer: The Effects of Cohesion and Range," *Administrative Science Quarterly*, vol. 48, no. 2, pp. 240-267, 2003.
- [53] J. A. Almendral, J. G. Oliveira, L. Lopez, M. A. F. Sanjuán and J. F. F. Mendes, "The interplay of universities and industry through the FP5 network," *New Journal of Physics*, vol. 9, p. 183, 2007.
- [54] A. JOHNSTON and R. HUGGINS, "University-industry links and the determinants of their spatial scope : a study of the knowledge intensive business services sector," *Papers in Regional Science*, vol. 96, no. 2, pp. 247-260, 2015.
- [55] M. G. Wynn and P. Jones, "Knowledge Transfer Partnerships and the Entrepreneurial University," *Industry and Higher Education*, vol. 31, no. 4, pp. 267-278, 2017.

- [56] M. G. Wynn and P. Jones, "CONTEXT AND ENTREPREURSHIP IN KNOWLEDGE TRANSFER PARTNERSHIPS WITH SMALL BUSINESS ENTERPRISES," *International Journal of Entrepreneurship and Innovation*, vol. 20, no. 1, pp. 8-20, 2018.
- [57] E. de Wit-de Vries, W. A. Dolfsma, . H. J. van der Windt and M. P. Gerkema, "Knowledge transfer in university–industry research partnerships: a review," *Journal of Technology Transfer* , vol. 44, p. 1236–1255, 2019.
- [58] D. Gertner, J. Roberts and D. Charles, "University-Industry Collaboration: A CoPs Approach to KTP," *Journal of Knowledge Management*, vol. 15, no. 4, pp. 625-647, 2011.
- [59] H. ALDRICH and D. HERKER, "Boundary Spanning Roles and Organization Structure," *The Academy of Management Review*, vol. 2, no. 2, pp. 217-230, 1977.
- [60] A. M. DIMA, S. HADAD and I. LUCHIAN, "Review on the dimensions of business-university alliances," in *Proceedings of the International Conference on Business Excellence* , Warsaw, 2017.
- [61] R. Nováková, "Scientific-Research Cluster as a form of Knowledge Transfer," *DRVNA INDUSTRIJA*, vol. 62, no. 4, pp. 291-300, 2011.
- [62] H. Confraria and F. Vargas, "Scientific systems in Latin America: performance, networks, and collaborations with industry," *The Journal of Technology Transfer*, vol. 44, p. 874–915, 2019.
- [63] V. Tartari , M. Perkmannb and A. Sal, "In good company: The influence of peers on industry engagement by," *Research Policy*, vol. 43, pp. 1189-1203, 2014.
- [64] K. Zalewska-Kurek, K. Egedova, P. A. T. M. Geurts1 and H. E. Roosendaal, "Knowledge transfer activities of scientists," *Journal of technology transfer*, vol. 43, no. 1, pp. 139-158, 2018.
- [65] M. Francoa and P. Cláudia , "A case study about cooperation between University Research Centres:," *Journal of Innovation*, vol. 4, pp. 62-69, 2019.
- [66] K. Zalewska-Kurek and R. Harms, "Managing autonomy in university–industry research: a case of collaborative Ph.D. projects in the Netherlands," *Review of Managerial Science*, vol. 14, p. 393–416, 2020.
- [67] R. Lorio, S. Labory and F. Rentocchini, "The importance of pro-social behaviour for the breadth and depth of knowledge transfer activities: An analysis of Italian academic scientists," *Researcy Plicy*, vol. 46, no. 2, pp. 497-509, 2017.
- [68] K. Miller, A. Alexander, J. A. Cunningham and E. Albats, "Enterpreneurial academics and academic entrepreneurs: A systematic literature review," *International Journal of Technology Management*, vol. 77, no. 1/2/3, pp. 9-36, 2018.
- [69] P. D 'este, S. Mahdi, A. Neely and F. Rentocchini, "Inventors and entrepreneurs in academia: What types of skills and experience matter?," *Technovation* , vol. 32, no. 5, pp. 292-303, 2012.

- [70] Z. Zhao and J. Cai, "Individual Differences, Self-Efficacy, and Chinese Scientists' Industry Engagement," *Information*, vol. 8, no. 4, pp. 160-175, 2017.
- [71] M. Belitski and K. Heron, "Expanding Entrepreneurship Education Ecosystems," *Journal of Management Development*, vol. 36, no. 2, pp. 163-177, 2017.
- [72] C. Sansom and P. Shore, "Precision engineering for optical applications: Knowledge Transfer into UK industry," in *11th Education and Training in Optics and Photonics Conference*, St. Asaph, United Kingdom, 2009.
- [73] M. Steinmo and E. Rasmussen, "The interplay of cognitive and relational social capital dimensions in university-industry collaboration: Overcoming the experience barrier," *Research Policy*, vol. 47, pp. 1164-1174, 2018.
- [74] T. Harpham, E. Grant and E. Thomas, "Measuring social capital with health surveys: key issues," *Health Policy and Planning*, vol. 17, no. 1, pp. 106-111, 2002.
- [75] J. Nahapiet and S. Ghoshal, "Social Capital, Intellectual Capital, and the Organizational Advantage," *The Academy of Management Review*, vol. 32, no. 2, pp. 242-266, 1998.
- [76] "Learning and Protection of Proprietary Assets in Strategic Alliances: Building Relational Capital," *Strategic Management Journal*, vol. 21, no. 3, pp. 217-237, 2000.
- [77] O. Al-Tabbaa and S. Ankrah, "Social capital to facilitate 'engineered' university-industry collaboration for technology transfer: A dynamic perspective," *Technological Forecasting & Social Change*, vol. 104, pp. 1-15, 2016.
- [78] L. Leydesdorff, "The Triple Helix of University-Industry-Government Relations," in *Encyclopedia of Creativity, Innovation, and Entrepreneurship*, New York, Springer, 2012, pp. 366-376.
- [79] H. Etkowitz and L. Leydesdorff, "The dynamics of innovation: from National Systems and "Mode 2" to a Triple Helix of university-industry-government relations," *Research Policy*, vol. 29, no. 2, pp. 109-123, 2000.
- [80] E. Carayannis and D. F. Campbell, *Int. J. Technology Management*, vol. 46, no. 3/4, pp. 201-234, 2009.
- [81] K. Miller, R. McAdam and M. McAd, "A systematic literature review of university technology transfer from a quadruple helix perspective: Toward a research agenda," *R&D Management*, vol. 48, no. 1, pp. 7-24, 2017.
- [82] M. McAdam, Kristel Miller, Rodney McAdam, K. Miller and R. McAdam, "Understanding Quadruple Helix Relationships of University Technology Commercialisation: A Micro Level Approach," *Studies in Higher Education*, vol. 43, no. 6, pp. 1058-1073, 2016.



- [83] T. Kinnunen, S. Rinkinen, J. Majava and J. Gillette, "Strategic structure and implementation of regional triple helix collaboration: Comparative case study," in *Proceedings of the 11th European Conference on Innovation and Entrepreneurship*, Jyväskylä , 2016.
- [84] V. Cini and N. Drvenkar, "European Union Triple Helix Model of "the new industry"," in *Interdisciplinary Symposium : Interdisciplinary Management Research (4 ; 2010)*, Porec, 2010.
- [85] G. Basarac, Interviewee, *voditelj Sluzbe za poslove koordinacije i programiranja ESI fondova, Uprava za strateško planiranje i koordinaciju EU fondova*. [Interview]. 10 2 2018.
- [86] J. Ma, "Developing Joint R&D Institutes between Chinese Universities and International Enterprises in China's Innovation System: A Case at Tsinghua University," *Sustainability*, vol. 11, no. 24, p. 7133, 2019.
- [87] Eurostat, "Patent statistics," Eurostat, Bruxelles, 2017.
- [88] C. J. Serrano, "The dynamics of the transfer and renewal of patents," *The Rand Journal of Economics*, vol. 41, no. 4, pp. 686-708, 2010.
- [89] M. Holgersson and L. Aaboen, "A literature review of intellectual property management in technology transfer offices: From appropriation to utilization," *Technology in Society*, vol. 59, p. 101132, 2019.
- [90] C. Dahlborg, D. Lewensohn, R. Danell and C. J. Sundberg, "To Invent and Let Others Innovate: a Framework of Academic Patent Transfer Modes," *Journal of Technology Transfer*, vol. 42, p. 538–563, 2017.
- [91] F. E. García-Muina and R. González-Sánchez, "Absorptive routines and international patent performance," *Business Research Quarterly*, vol. 20, no. 1, pp. 96-111, 2017.
- [92] W. M. Cohen and D. A. Levinthal, "Absorptive Capacity: A New Perspective on Learning and Innovation," *Administrative Science Quarterly*, vol. 35, pp. 128-152, 1990.
- [93] C. Lawson, "Academic inventions outside the university: Investigating patent ownership in the UK," *Industry and Innovation*, vol. 20, no. 5, pp. 385-398 , 2013.
- [94] B. Andersen and F. Rossi, "UK Universities Look Beyond the Patent Policy Discourse in their Intellectual Property Strategies," *Science and Public Policy*, vol. 38, no. 4, pp. 254-268, 2011.
- [95] S. Sterckx, "Patenting and Licensing of University Research: Promoting Innovation or Undermining Academic Values?," *Science and Engineering Ethics*, vol. 17, no. 1, pp. 45-64, 2009.
- [96] D. Czarnitzki, K. Hussinger and C. Schne, "The nexus between science and industry: Evidence from faculty inventions," *The Journal of Technology Transfer*, vol. 37, no. 5, pp. 755-776, 2012.

- [97] I. M. Bodas Freitas , A. Geuna and F. Rossi, "Finding the right partners: Institutional and personal modes of governance of university–industry interactions," *Research Policy*, vol. 42, p. 50–62, 2013.
- [98] D. M. Weckowska, "Learning in university technology transfer offices: transactions-focused and relations-focused approaches to commercialization of academic research," *Technovation*, Vols. 41-42, pp. 62-74, 2015.
- [99] W. Klomklieng, P. Ratanapanee, S. Tanchareon and K. Meesap, "Strengthening a Research Cooperation Using a Triple Helix Model: Case Study of Poultry Industry in Thailand," *Procedia - Social and Behavioral Sciences*, vol. 52, p. 120 – 129, 2012.
- [100] F. Tunca and O. N. Kanat, "Harmonization and Simplification Roles of Technology Transfer Offices for Effective University – Industry Collaboration Models," *Procedia Computer Science*, vol. 158, p. 361–365, 2019.
- [101] M. Sánchez-Barrioluengo and P. Benneworth, "Is the entrepreneurial university also regionally engaged? Analysing the influence of university's structural configuration on third mission performance," *Technological Forecasting and Social Change*, vol. 141, pp. 206-218, 2019.
- [102] P. Intarakumnerd, "The Roles of Intermediaries in Clusters: The Thai Experiences in High-tech and Community-based Clusters," *Asian Journal of Technology Innovation*, vol. 13, no. 2, pp. 23-43, 2005.
- [103] A. Abbas, A. Avdic, K. Chang Barker and P. Xiaobao, "KNOWLEDGE TRANSFER FROM UNIVERSITIES TO INDUSTRY THROUGH UNIVERSITY TECHNOLOGY TRANSFER OFFICES," *Science and Innovation*, vol. 14, no. 2, p. 05—18 , 2018.
- [104] E. Villani, E. Rasmussen and R. Grimaldi, "How intermediary organizations facilitate university–industry technology transfer: A proximity approach," *Technological Forecasting & Social Change*, vol. 114, pp. 86-102, 2016.
- [105] D. S. Siegela, P. Westheadb and M. Wrightb, "Assessing the impact of science parks on the research productivity of firms: Exploratory evidence from the United Kingdom," *International Journal of Industrial Organization*, vol. 21, p. 1357–1369, 2003.
- [106] N. Perić, "ULOGA INOVACIJSKOG CENTRA NIKOLA TESLA U UNAPRJEĐENJU," in *Godišnjak 2021, Doprinos članova Akademije razvoju sustava znanstveno-nastavnih institucija*, Zagreb, Hrvatska, Akademija tehničkih znanosti Hrvatske, 2022, pp. 347-371.
- [107] D. C. European Cmmission, "Digital Economy and Society Index (DESI) 2020," [Online]. Available: <https://digital-strategy.ec.europa.eu/en/library/digital-economy-and-society-index-desi-2020>. [Accessed 1 1 2022].
- [108] E. Commission, "Digital Economy and Society Index (DESI) 2020; Integration of digital technology," 2020. [Online]. Available: [249](https://digital-</a></p>
</div>
<div data-bbox=)

- strategy.ec.europa.eu/en/library/digital-economy-and-society-index-desi-2020. [Accessed 11 1 2022].
- [109] E. Commission, "Digital Economy and Society Index (DESI) 2020 ; Croatia," 2020. [Online]. Available: file:///C:/Users/jurci/Downloads/10\_desi\_2020\_-\_croatia\_-\_eng\_CB8F75A3-90CF-F710-6D05B5E904BBOFFA\_66908.pdf. [Accessed 11 1 2022].
- [110] g. Rissola and J. Sorvik, "Digital Innovation Hubs in Smart Specialisation Strategies," Publications Office of the European Union, 2018, Luxembourg, 2018.
- [111] E. Commission, "DIH Enhanced Learning Programme," January 2019. [Online]. Available: <https://ec.europa.eu/digital-single-market/en/news/dihelp-call-30-digital-innovation-hubs-take-part-training-programme>.
- [112] WG1, "Digital Innovation Hubs: Mainstreaming Digital Innovation Across All Sectors. European Commission," European Commission, 2017.
- [113] J. Miörner, A. Kalpaka, J. Sorvik and J. Wernberg, "Exploring heterogeneous Digital Innovation Hubs in their context," Publications Office of the European Union, 2019, Luxembourg, 2019.
- [114] R. Virkkunen, K. Still and L. Rosso, "Digital Innovation Hubs in Finland," 2019. [Online]. Available: [https://julkaisut.valtioneuvosto.fi/bitstream/handle/10024/161585/TEM\\_2019\\_27\\_Digital\\_Innovation\\_Hubs\\_in\\_Finland.pdf?sequence=1](https://julkaisut.valtioneuvosto.fi/bitstream/handle/10024/161585/TEM_2019_27_Digital_Innovation_Hubs_in_Finland.pdf?sequence=1). [Accessed 15 1 2020].
- [115] EC, "Digital Innovation Hubs in Digital Europe Programme," December 2018. [Online]. Available: [https://ec.europa.eu/futurium/en/system/files/ged/digital\\_innovation\\_hubs\\_in\\_digital\\_europe\\_programme\\_final2\\_december.pdf](https://ec.europa.eu/futurium/en/system/files/ged/digital_innovation_hubs_in_digital_europe_programme_final2_december.pdf). [Accessed 11 6 2019].
- [116] G. Rissola and J. Sörvik, "Digital Innovation Hubs in Smart Specialisation Strategies," 24 1 2018. [Online]. Available: <https://digital-strategy.ec.europa.eu/en/library/digital-innovation-hubs-smart-specialisation-strategies>. [Accessed 11 6 2019].
- [117] J. Miörner, G. Rissola, J. Sörvik and J. Wernberg, "Putting Digital Innovation Hubs into Regional Context," 2019. [Online]. Available: <https://op.europa.eu/en/publication-detail/-/publication/666fbb10-df40-11e9-9c4e-01aa75ed71a1/language-en/format-PDF>. [Accessed 11 1 2020].
- [118] E. Commission, "Smart Specialisation Platform," 10 May 2020. [Online]. Available: <https://s3platform.jrc.ec.europa.eu/digital-innovation-hubs-tool>. [Accessed 11 June 2020].
- [119] TNO, "Digital Innovation Hub Networks," [Online]. Available: <https://dihnet.eu/>.
- [120] EC, "EU budget: Commission proposes €9.2 billion investment in first ever digital programme," 6 6 2018. [Online]. Available: [https://ec.europa.eu/commission/presscorner/detail/en/IP\\_18\\_4043](https://ec.europa.eu/commission/presscorner/detail/en/IP_18_4043). [Accessed 11 6 2019].

- [121] E. COmmission, "Digital Europe Programme (DIGITAL)," 17 Nov 2021. [Online]. Available: [https://ec.europa.eu/info/funding-tenders/opportunities/docs/2021-2027/digital/wp-call/2021/call-fiche\\_digital-2021-edih-01\\_en.pdf](https://ec.europa.eu/info/funding-tenders/opportunities/docs/2021-2027/digital/wp-call/2021/call-fiche_digital-2021-edih-01_en.pdf). [Accessed 19 11 2022].
- [122] E. Commission, "European Digital Innovation Hubs," 7 Sept 2022. [Online]. Available: <https://digital-strategy.ec.europa.eu/en/activities/edihs>. [Accessed 20 11 2020].
- [123] E. Commission, "DG CNECT - Digital Transformation Accelerator for the network of EDIH," 13 Jan 2022. [Online]. Available: <https://digital-skills-jobs.europa.eu/en/opportunities/funding/dg-cnect-digital-transformation-accelerator-network-edih>. [Accessed 19 11 2022].
- [124] E. COmmission, "www.ec.europa.eu/newsroom/repository," 10 11 2021. [Online]. Available: [https://ec.europa.eu/newsroom/repository/document/2021-45/C\\_2021\\_7911\\_1\\_EN\\_annexe\\_acte\\_autonome\\_cp\\_part1\\_v2\\_d4ygL3fB7OJrEhLGIXBaC5w0X0\\_80907.pdf](https://ec.europa.eu/newsroom/repository/document/2021-45/C_2021_7911_1_EN_annexe_acte_autonome_cp_part1_v2_d4ygL3fB7OJrEhLGIXBaC5w0X0_80907.pdf). [Accessed 19 11 2022].
- [125] D. S. Siegel, D. A. Waldman, L. E. Atwater and A. N. Link, "Toward a model of the effective transfer of scientific knowledge from academicians to practitioners: qualitative evidence from the commercialization of university technologies," *Journal of Engineering and Technology Management JET-M*, vol. 21, p. 115–142, 2004.
- [126] D. S. Siegela, D. A. Waldman, L. E. Atwater and A. N. Link, "Commercial knowledge transfers from universities to firms: improving the effectiveness of university–industry collaboration," *Journal of High Technology Management Research*, vol. 93, pp. 1-23, 2003.
- [127] D. S. S. S. Siegel, R. Veugelers and M. Wright, "Technology transfer offices and commercialization of university intellectual property: performance and policy implications," *Oxford Review of Economic Policy*, vol. 23, p. 640–660, 2007.
- [128] L. Klerkx and C. Leeuwis, "Matching demand and supply in the agricultural knowledge infrastructure: Experiences with innovation intermediaries," *Food Policy*, vol. 33, p. 260–276, 2008.
- [129] D. N. Resende, D. G. Gibson and J. Jarret, "BTP—Best Transfer Practices. A tool for qualitative analysis of tech-transfer offices: A cross cultural analysis," *Technovation*, vol. 33, pp. 2-12, 2013.
- [130] A. Majchrzak, M. L. Markus and J. Wareham, "Designing for Digital Transformation: Lessons for Information Systems Research from the study of ICT and Societal Challenges," *MIS Quarterly*, vol. 40, no. 2, pp. 267-277, 2016.
- [131] P. Kivimaaa, W. Boonc and S. Hyysalod, "Towards a typology of intermediaries in sustainability transitions: A systematic review and a research agenda," *Research Policy*, vol. 48, p. 1062–1075, 2019.

- [132] S. R. Bradley, C. S. H. S. Hayter and . A. N. Link, "Models and Methods of University Technology Transfer," *Foundations and Trends® in Entrepreneurship*, vol. 9, no. 6, p. 571–650, 2013.
- [133] S. Lee, G. Park, B. Y. Yoon and J. Park, "Open innovation in SMEs—An intermediated network model," *Research Policy*, vol. 39, p. 290–300, 2010.
- [134] G. M. W. M. Winch and R. Courtney, "The Organization of Innovation Brokers: An International Review," *Technology Analysis & Strategic Management*, vol. 19, no. 6, p. 747–763, 2007.
- [135] T. Cook, "The Role of Technology Transfer Intermediaries in Commercializing Intellectual Property through Spinouts and Start-ups," [iphandbook.org](http://iphandbook.org).
- [136] J. H. LASHARI, A. BHUTTO, Q. M. M. ABRO, Z. A. MEMON and I. B. NAQVI, "Examining Knowledge Transfer Channels for Development of Environment Sector in Sindh," *Mehran University Research Journal of Engineering & Technology*, vol. 37, no. 2, pp. 417-428, 2018.
- [137] F. Rentocchini, P. D'Este, L. Manjarrés-Henríquez and R. Grimaldi, "The relationship between academic consulting and research performance: evidence from five Spanish universities," *International Journal of Industrial Organization*, vol. 32, no. 1, pp. 70-83, 2013.
- [138] J. Olmos-Peñuelaa, E. Castro-Martínez and P. D'Este, "Knowledge Transfer Activities in social sciences and humanities: Explaining the interactions of research groups with non-academic agents," *Research Policy*, vol. 43, no. 4, pp. 696-706, 2014.
- [139] D.-G. Owusu-Manu, D. J. Edwards, E. Anneli Pärn, M. F. Antwi-Afari and C. Aigbavboa, "The knowledge enablers of knowledge transfer: a study in the construction industries in Ghana," *Journal of Engineering Design and Technology*, vol. 16, no. 2, pp. 194-210, 2018.
- [140] K. Hayes and . A. J. Fitzgerald, "Managing occupational boundaries to improve innovation outcomes in industry-research organisations," *Journal of Management & Organization*, vol. 15, no. 4, pp. 423-437, 2009.
- [141] A. Rosli, M. de Silva, F. Rossi and N. Yip, "The long-term impact of engaged scholarship: How do SMEs capitalise on their engagement with academics to explore new opportunities?," *International Small Business Journal*, vol. 36, no. 4, p. 400–428, 2018.
- [142] A. Fujiwara, "Who Works at the Interface in Knowledge Spillover Across Organizational Boundaries?," *The Review of Socionetwork Strategies*, vol. 11, p. 65–81, 2017.
- [143] N. Lockett, R. Kerr and S. Robinson, "Multiple Perspectives on the Challenges for Knowledge Transfer between Higher Education Institutions and Industry," *International Small Business Journal*, vol. 26, no. 2, pp. 661-681, 2008.
- [144] A. Alexander, D. P. Martin, C. Manolchev and K. Miller, "University–industry collaboration: using meta-rules to overcome barriers to knowledge transfer," *The Journal of Technology Transfer*, vol. 45, p. 371–392, 2020.

- [145] L. Argote and E. Fahrenkopf , "Knowledge Transfer in Organizations: The Role of Members, Tasks, Tools, and Networks," *Organizational Behavior and Human Decision Processes*, vol. 136, pp. 146-159, 2016.
- [146] A. T. Alexander and S. J. Childe, "IFIP International Conference on Advances in Production Management Systems," in *IFIP Advances in Information and Communication Technology* , Rhodos, Greece, 2012.
- [147] W. M. Cohen and D. A. Levinthal, "Absorptive Capacity: A New Perspective on Learning and Innovation," *Administrative Science Quarterly*, vol. 35, pp. 128-152, 1990.
- [148] K. Atta-Owusu, "Oasis in the desert? Bridging academics' collaboration activities as a conduit for global knowledge flows to peripheral regions," *Regional Studies, Regional Science*, vol. 6, no. 1, pp. 265-280, 2019.
- [149] M. Arif , M. Al Zubi , A. D. Gupta, C. Egbu , R. O. Walton and R. Islam , "Knowledge sharing maturity model for," *Engineering, Construction and Architectural Management*, vol. 24, no. 1, pp. 170-188, 2017.
- [150] M. S. Lowe, A. M. W. M. Williams, G. Shaw and K. Cudworth, "Self-organizing innovation networks, mobile knowledge carriers and diasporas: insights from a pioneering boutique hotel chain," *Journal of Economic Geography*, vol. 12, no. 5, p. 1113–1138, 2012.
- [151] R. D. Fitjar and M. Gjelsvik, "Why do firms collaborate with local universities?," *Regional Studies*, vol. 52, no. 11, pp. 1-12, 2018.
- [152] I. M. Bodas Freitas and B. Verspagen, "The motivations, institutions and organization of university-industry collaborations in the Netherlands," *Journal of Evolutionary Economics*, vol. 27, p. 379–412, 2017.
- [153] R. F. Otero, G. Bayliss-Brown and M. Papathanassiou, "Ocean Literacy and Knowledge Transfer Synergies in Support of a Sustainable Blue Economy," *Frontiers in Marine Science* , vol. 6, 2019.
- [154] P. Matulova , P. Maresova , M. A. Tareq and K. Kuča, "Open Innovation Session as a Tool Supporting Innovativeness in Strategies for High-Tech Companies in the Czech Republic," *Economies*, vol. 6, no. 4, pp. 69-82, 2018.
- [155] E. Blümel, "Global Challenges and Innovative Technologies Geared toward New Markets: Prospects for Virtual and Augmented Reality," in *2013 International Conference on Virtual and Augmented Reality in Education*, 2013.
- [156] J. Bröchner and O. Lagerqvist, "From ideas to construction innovations: firms and universities collaborating," *Construction Economics and Building*, vol. 16, no. 1, pp. 76-89, 2016.
- [157] K. Falk and G. Muller, "Embedded Master's Students Conduct Highly Relevant Research Using Industry as Their Laboratory," *Technology Innovation Management Review*, vol. 9, no. 5, pp. 54-74, 2019.

- [158] F. Barjak, N. Es-Sadki and A. Arundel, "The effectiveness of policies for formal knowledge transfer from European universities and public research institutes to firms," *Research Evaluation*, vol. 24, p. 4–18, 2015.
- [159] A. Alexander and S. Childe, "A Framework for the Transfer of Knowledge between Universities and Industry," in *International Conference on Advances in Production Management Systems (APMS)*, Stavanger, Norway, 2011.
- [160] A. Muscio, D. Quaglione and G. Vallanti, "Does government funding complement or substitute private research funding to universities?," *Research Policy*, vol. 42, pp. 63-75, 2013.
- [161] P. Sánchez-Sellero, J. Rosell-Martínez and J. M. García-Vázquez, "Absorptive capacity from foreign direct investment in Spanish manufacturing firms," *International Business Review*, vol. 23, no. 2, pp. 429-439, 2014.
- [162] P. Srivastava and S. Chandra, "Technology Commercialization: Indian University Perspective," *Journal of Technology, Management & Innovation*, vol. 7, no. 4, pp. 121-131, 2012.
- [163] N. Kundu, C. Bhar and V. Pandurangan, "Development of Framework for an Integrated Model for Technology Transfer," *Indian Journal of Science and Technology*, vol. 8, no. 35, pp. 1-14, 2015.
- [164] A. M. Bernardos Barbolla and J. R. Casar Corredera, "Critical factors for success in university-industry research projects," *Technology Analysis and Strategic Management*, vol. 21, no. 5, pp. 599-616, 2009.
- [165] P. Maresova, R. Stemberkova and O. Fadeyi, "Models, Processes, and Roles of Universities in Technology Transfer Management: A Systematic Review," *Administrative Sciences*, vol. 9, no. 3, pp. 67-103, 2019.
- [166] P. Salwan, "Technology Transfer and Technology Management in Strategic Systems," *Defence Science Journal*, vol. 55, no. 2, pp. 141-148, 2005.
- [167] Y. V. Smirnova, "Knowledge, Knowledge Transfer, Technology Transfer: A Conceptualization," in *Procedia of 6th International Conference on Building Cultural Bridges: Integrating Languages, Linguistics, Literature, Translation and Journalism into Education*, Almaty, Kazakhstan, 2014.
- [168] M. Abreu, V. Grinevich, A. Hughes, M. Kitson and P. Ternouth, "Universities, Business and Knowledge Exchange," Council for Industry and Higher Education, London, 2008.
- [169] S. Gopalakrishnan and M. D. Santoro, "Distinguishing Between Knowledge Transfer and Technology Transfer Activities: The Role of Key Organizational Factors," *IEEE Transactions on Engineering Management*, vol. 51, no. 1, pp. 57-69, 2004.
- [170] Y. Smirnova, "Knowledge, Knowledge Transfer, Technology Transfer: A Conceptualization," in *Proceedings of International Conference on Building Cultural Bridges: Integrating Languages,*

*Linguistics, Literature, Translation and Journalism into Education*At, Almaty, Kazakhstan, 2014.

- [171] T. Mikkonen, C. Lassenius, T. Mannisto, M. Oivo and J. Jarvinen, "Continuous and Collaborative Technology Transfer: Software Engineering Research with Real-time Industry Impact," *Information and Software Technology*, vol. 95, pp. 34-45, 2018.
- [172] T. Hameed, P. von Staden and K.-S. Kwon, "Sustainable Economic Growth and the Adaptability of a National System of Innovation: A Socio-Cognitive Explanation for South Korea's Mired Technology Transfer and Commercialization Process," *Sustainability*, vol. 10, no. 5, pp. 1-26, 2018.
- [173] D. N. Boehm and T. Hogan, "'A jack of all trades': the role of PIs in the establishment and management of collaborative networks in scientific knowledge commercialisation," *Journal of Technology Transfer*, vol. 39, p. 134–149, 2012.
- [174] J. Han, "Technology Commercialization through Sustainable Knowledge Sharing from University-Industry Collaborations, with a Focus on Patent Propensity," *Sustainability*, vol. 9, no. 10, pp. 1-16, 2017.
- [175] J. Wapner, "The leap to industry," *Nature*, vol. 533, p. pagesS13–S15, 2016.
- [176] J. Gosensa, H. Hellsmark, T. Kåberger, L. Liu, B. A. Sandén, S. Wang and L. Zhao, "The limits of academic entrepreneurship: Conflicting expectations about commercialization and innovation in China's nascent sector for advanced bio-energy technologies," *Energy Research & Social Science*, vol. 37, pp. 1-11, 2018.
- [177] L. L. Meijer, J. C. C. M. Huijben, A. van Boxstael and A. G. L. Romme, "Barriers and drivers for technology commercialization by SMEs in the Dutch sustainable energy sector," *Renewable and Sustainable Energy Reviews*, vol. 112, pp. 114-126, 2019.
- [178] A. Sengupta and A. S. Ray, "University research and knowledge transfer: A dynamic view of ambidexterity in british universities," *Research Policy*, vol. 46, no. 5, pp. 881-897, 2017.
- [179] J. B. Powers and E. G. Campbell, "Technology Commercialization Effects on the Conduct of Research in Higher Education," *Research in Higher Education*, vol. 52, no. 3, p. 245–260, 2011.
- [180] B. D. Wright, K. Drivas, Z. Lei and S. A. Merrill, "Technology transfer: Industry-funded academic inventions boost innovation," *Nature*, vol. 504, no. 7492, pp. 297-9, 2014.
- [181] A. E. Manyuchi, "Foreign Direct Investment and the Transfer of Technologies to Angola's Energy Sector," *Africa Spectrum*, vol. 51, no. 1, p. 55–83, 2016.
- [182] M. Rojec and M. Knell, "Why is there a lack of evidence on knowledge spillovers from foreign direct investment?," *Journal of Economic Surveys*, vol. 32, no. 3, pp. 579-612, 2017.



- [183] M. Apostolov, "Foreign Direct Investments Induced Innovation? A Case Study – Macedonia," *Comparative Economic Research*, vol. 19, no. 1, pp. 1-25, 2016.
- [184] J. Onken, R. Aragon and A. Calcagno, "Geographically-Related Outcomes of U.S. Funding for Small Business Research and Development: Results of the Research Grant Programs of a Component of the National Institutes of Health," *Evaluation and Program Planning*, vol. 77, no. 7, 2019.
- [185] H. Hottenrott and S. Thorwarth, "Industry Funding of University Research and Scientific Productivity," *KYKLOS*, vol. 64, no. 4, p. 534–555, 2011.
- [186] E. Thomas, V. Marques Vieira and A. Balestrin, "Mind the Gap: Lessons from the UK to Brazil about the Roles of TTOs throughout Collaborative R&D Projects," *BAR - Brazilian Administration Review*, vol. 14, no. 1, pp. 1-22, 2017.
- [187] M. Cervantes and D. Meissner, "Commercialising Public Research under the Open Innovation Model: New Trends," *Foresight and STI Governance*, vol. 8, no. 3, pp. 70-81, 2014.
- [188] M. Friedrichsten, H. Zarea, A. Tayebi and F. A. S. Abad, "Competitive strategies of knowledge and innovation commercialization: a unified swot and fuzzy ahp approach," *AD-minister*, vol. 30, pp. 45-72, 2017.
- [189] V. V. Krishna, "Universities in the National Innovation Systems: Emerging Innovation Landscapes in Asia-Pacific," *Journal of Open Innovation: Technology, Market, and Complexity*, vol. 5, no. 3, pp. 1-21, 2019.
- [190] J. L. Flagg, J. P. Lane and M. M. Lockett, "Need to Knowledge (NtK) Model: An evidence-based framework for generating technological innovations with," *Implementation Science*, vol. 8, no. 1, p. 21, 2013.
- [191] D. Resende and M. Bravo, "A TOP-DOWN AND BOTTOM-UP APPROACH TO IMPROVE REGIONAL INNOVATION ECOSYSTEMS IN PORTUGAL," *Brazilian Journal of Operations & Production Management*, vol. 13, no. 1, p. 86–93, 2016.
- [192] J. Li, H. Fang, S. Fang and S. E. Siddika, "Investigation of the Relationship among University–Research Institute–Industry Innovations Using a Coupling Coordination Degree Model," *Sustainability*, vol. 10, no. 6, pp. 1-18, 2018.
- [193] D. Bourletidis, "The Strategic Model of Innovation Clusters: Implementation of Blue Ocean Strategy in a typical Greek Region," *Procedia - Social and Behavioral Sciences*, vol. 148, p. 645 – 652, 2014.
- [194] G. DEMİRDÖĞEN and Z. IŞIK, "Environmental Scanning Approach to Assess Innovation and Technology Transfer Performance of Construction Companies," *Tehnički vjesnik*, vol. 26, no. 3, pp. 617-624, 2019.

- [195] A. Albersa, N. Bursac, L. Maul and M. Mair, "The role of in-house intermediaries in innovation management – Optimization of technology transfer processes from cross-industry," in *24th CIRP Design Conference*, Karlsruhe, Germany, 2014.
- [196] J. STANKEVIČIENĖ, L. KRAUJALIENĖ and A. VAICIUKEVIČIŪTĖ, "ASSESSMENT OF TECHNOLOGY TRANSFER OFFICE PERFORMANCE FOR VALUE CREATION IN HIGHER EDUCATION INSTITUTIONS," *Journal of Business Economics and Management*, vol. 18, no. 6, p. 1063–1081, 2017.
- [197] B. Huggett, "Reinventing tech transfer," *nature biotechnology*, vol. 32, no. 12, pp. 1184-1192, 2014.
- [198] C. S. Vac and A. Fitiu , "Building Sustainable Development through Technology Transfer in a Romanian University," *Sustainability*, vol. 9, no. 11, p. 2042, 2017.
- [199] B. Dolan, J. A. Cunningham, M. Menter and C. McGregor, "The Role and Function of Cooperative Research Centers in Entrepreneurial Universities: A Micro Level Perspective," *Management Decision*, vol. 57, pp. 3406-3425, 2019.
- [200] L. Closs, G. C. Ferreira, A. Soria, C. Sampaio and M. G. Perin, "Organizational Factors that Affect the University-Industry Technology Transfer Processes of a Private University," *Journal of Technology Management and Innovation*, vol. 7, no. 1, pp. 104-117, 2012.
- [201] S. Lee and O. A. Shvetsova, "Optimization of the Technology Transfer Process using Gantt Charts and Critical Path Analysis Flow Diagrams: Case Study of the Korean Automobile Industry," *Processes*, vol. 7, no. 12, p. 917, 2019.
- [202] X.-D. Qian, J. Xia, W. Liu and S.-B. Tsai, "An Empirical Study on Sustainable Innovation Academic Entrepreneurship Process Model," *Sustainability*, vol. 10, no. 6, pp. 1-15,, 2018.
- [203] M. McAdam, K. Miller and R. McAdam, "University Business Models in Disequilibrium: Engaging Industry and End Users within University Technology Transfer Processes," *R & D Management*, vol. 47, no. 3, pp. 458-472, 2017.
- [204] P. Maresova , R. Stemberkova and O. Fadeyi , "Models, Processes, and Roles of Universities in Technology Transfer Management: A Systematic Review," *Administrative Sciences*, vol. 9, no. 3, p. 67, 2019.
- [205] G. León, "COOPERATIVE MODELS FOR INFORMATION TECHNOLOGY TRANSFER IN THE CONTEXT OF OPEN INNOVATION," in *IFIP International Working Conference on Organizational Dynamics of Technology-Based Innovation*, Manchester, UK, 2007.
- [206] H. V. Levy, "Transferability and Commercialization of Patent Rights: Economic and Practical Perspectives," *Journal of Entrepreneurship, Management and Innovation*, vol. 8, no. 2, pp. 44-59, 2012.

- [207] G. Dalmarco, M. Dewes, P. A. Zawislak and A. D. Padula, "Universities' Intellectual Property: Path for Innovation or Patent Competition?," *Journal of Technology Management and Innovation*, vol. 6, no. 3, pp. 159-170, 2011.
- [208] D. Czarnitzki, T. Doherr, K. Hussinger, P. Schliessler and A. A. Toole, "Knowledge Creates Markets: The Influence of Entrepreneurial Support and Patent Rights on Academic Entrepreneurship," *European Economic Review*, vol. 86, pp. 131-146, 2016.
- [209] G. A. Van Norman and R. Eisenkot, "Technology Transfer: From the Research Bench to Commercialization," *JACC: Basic to Translational Science*, vol. 2, no. 2, pp. 197-208, 2017.
- [210] H. G. Fica, "Exploring Knowledge Transfer at UC Engineering School," *Journal of Technology Management and Innovation*, vol. 13, no. 3, pp. 64-78, 2018.
- [211] J. Kirchherr and N. Matthews, "Technology transfer in the hydropower industry: An analysis of Chinese dam developers' undertakings in Europe and Latin America," *Energy Policy*, vol. 113, pp. 546-558, 2018.
- [212] D. Czarnitzki, W. Glänzel and K. Hussinger, "Heterogeneity of Patenting Activity and Its Implications for Scientific Research," *Research Policy*, vol. 38, no. 1, pp. 26-34, 2009.
- [213] P. Azoulay, W. Ding and T. Stuart, "THE IMPACT OF ACADEMIC PATENTING ON THE RATE, QUALITY AND DIRECTION OF (PUBLIC) RESEARCH OUTPUT," *THE JOURNAL OF INDUSTRIAL ECONOMICS*, vol. 57, no. 4, pp. 637-676, 2009.
- [214] C. B. Yang, "Role of patent analysis in corporate R&D," *Pharmaceutical Patent Analyst*, vol. 1, no. 1, pp. 5-7, 2012.
- [215] G. Gimenez, "The impact of the patent system on the social welfare: A critical view," *Intangible Capital*, vol. 14, no. 2, pp. 253-269, 2018.
- [216] Y. SERVATI and S. H. GHODSYPOUR, "ROBUST TECHNOLOGY TRANSFER POLICY MAKING USING SCENARIO BASED FUZZY TOPSIS –A CASE STUDY OF IRAN'S GAS INDUSTRY," *Applied Ecology and Environmental Research*, vol. 15, no. 3, pp. 593-610, 2017.
- [217] R. HUGGINS, A. JOHNSTON and R. STEFFENSON, "Universities, knowledge networks and regional policy," *Cambridge Journal of*, vol. 1, no. 2, pp. 321-340, 2008.
- [218] M. CAMILLERI, G. L. GAMBLE, S. L. KOPECKY, M. B. WOOD and M. L. HOCKEMA, "Principles and Process in the Development of the Mayo Clinic's Individual and Institutional Conflict of Interest Policy," in *Mayo Clinic Proceedings*, Rochester, MN, USA, 2005.
- [219] R.-P. David, S. Fernández-López, L. O. González and A. R. Sandiás, "A resource-based view of university spin-off activity: New evidence from the Spanish case," *Revista Europea de Direccion y Economia de la Empresa*, vol. 21, no. 3, p. 255–265, 2012.

- [220] N. van Stijn, F. J. van Rijnsoever and M. van Veelen, *Journal of Technolpgy Transf*, vol. 43, p. 674–713, 2018.
- [221] T. Erikson, M. Knockaert and M.-D. Foo, "Enterprising scientists: The shaping role of norms, experience and scientific productivity," *Technological Forecasting and Social Change*, vol. 99, pp. 211-221, 2015.
- [222] J. Edler, H. Fier and C. Grimpe, "International Scientist Mobility and the Locus of Technology Transfer," 2008. [Online]. Available: <https://www.zew.de/en/publications/international-scientist-mobility-and-the-locus-of-technology-transfer-1?msclid=f693efc2bb6811eca35885e7701b1945>. [Accessed 13 4 2022].
- [223] S. Wagner and M. C. Goossen, "Knowing Me, Knowing You: Inventor Mobility and the Formation of Technology-oriented Alliances," *The Academy of Management Journal*, vol. 61, no. 6, pp. 2026-2052, 2018.
- [224] M. Grzegorzcyk, "The role of culture-moderated social capital in technology transfer – insights from Asia and America," *Technological Forecasting and Social Change*, vol. 143, no. 1, pp. 132-141, 2019.
- [225] Z. Zhao, A. Broström and J. Cai, "Promoting academic engagement: university context and individual characteristics," *The Journal of Technology Transfer*, vol. 45, p. 304–337, 2018.
- [226] M. Blankesteyjn, B. Bossink and P. van der Sijde, "Science-based entrepreneurship education as a means for university-industry technology transfer," *International Entrepreneurship and Management Journal*, vol. 17, p. 779–808, 2021.
- [227] J. Achatz, S. Fuchs, C. Kleinert and S. Roßmann, "'We are a Motley Crew': Exploring the Careers of Men and Women Working at the University-Industry Interface," *Jpurnal of Technology Management & Innovation*, vol. 5, no. 1, p. 75–84, 2010.
- [228] S. J. Perry, E. M. Hunter and S. C. Currall, "Managing the innovators: Organizational and professional commitment among scientists and engineers," *Research Policy*, vol. 45, no. 6, pp. 1247-1262, 2016.
- [229] S. SCAGNELLI, L. VASILE and M. APOSTOLOV, "SURVIVAL DRIVERS OF POST-INCUBATED START-UPS: THE EFFECT OF ACADEMIC GOVERNANCE," *nternational Journal of Innovation Management*, vol. 23, no. 7, pp. 1-20, 2019.
- [230] F. R. Cáceres Carrasco and M.-T. Aceytuno Pérez, "Academic spin-offs incubation strategies: The case of the Andalusian region," *Cuadernos de Gestión*, vol. 15, no. 2, pp. 113-142, 2015.
- [231] P. P. Zachman and P. I. Dupertuis, "Singularities of the university spin-off in northern Argentina," in *4th World Conference on Information Systems and Technologies - WorldCIST'16*, Recife, PE, Brazil, 2016.

- [232] F. Brodack and A. Sinell, "Promoting Entrepreneurial Commitment: The Benefits of Interdisciplinarity," *Technology Innovation Management Review*, vol. 7, no. 12, pp. 6-13, 2017.
- [233] H.-f. Lee and M. Miozzo, "How does working on university-industry collaborative projects affect science and engineering doctorates' careers? Evidence from a UK research-based university," *The Journal of Technology Transfer*, vol. 40, no. 2, pp. 393-417, 2014.
- [234] J. A. Cunningham and A. N. Link, "Fostering University-Industry R&D Collaborations in European Union Countries," *International Entrepreneurship and Management Journal*, vol. 11, no. 4, p. 849-860, 2015.
- [235] R. Kneller, M. Mongeon, J. Cope, C. Garner and P. Ternouth, "Industry-University Collaborations in Canada, Japan, the UK and USA – With Emphasis on Publication Freedom and Managing the Intellectual Property Lock-Up Problem," *PLoS ONE*, vol. 9, no. 3, 2014.
- [236] S. Ndlovu, "Presidential Address: Industry-academic collaborations - an opportunity for the minerals industry during the economic downturn," *The Journal of the Southern African Institute of Mining and Metallurgy*, vol. 117, no. 9, pp. 839-847, 2017.
- [237] D. J. Borah, K. Malik and S. Massini, "Are engineering graduates ready for R&D jobs in emerging countries? Teaching-focused industry-academia collaboration strategies," *Research Policy*, vol. 48, no. 9, pp. 1-15, 2019.
- [238] N. Ghebrihiwet, "FDI technology spillovers in the mining industry: Lessons from South Africa's mining sector," *Resources Policy*, vol. 62, pp. 463-471, 2019.
- [239] D. Dell'Anno and M. del Giudice, "Absorptive and desorptive capacity of actors within university-industry relations: does technology transfer matter?," *Journal of Innovation and Entrepreneurship*, vol. 4, no. 1, pp. 1-20, 2015.
- [240] K. M. Klimczak, W. Machowiak, Y. Shachmurov and I. Stanie, "Perceived collaborative risk in small and medium technology enterprises," *Informa UK Limited in Journal of Small Business Management*, pp. 1-20, 2020.
- [241] A. Mazurkiewicz and B. Poteralska, "Technology Transfer Barriers and Challenges Faced by R&D Organisations," in *7th International Conference on Engineering, Project, and Production Management*, Białystok/Poland, 2017.
- [242] R. Glass, A. Meissner, C. Gebauer, S. Sturmer and J. Metternich, "Identifying the barriers to Industrie 4.0," in *51st CIRP Conference on Manufacturing Systems*, Nantes, France, 2018.
- [243] A. Reveiu and M. Dardala, "The Role of Universities in Innovative Regional Clusters. Empirical Evidence from Romania," in *3rd World Conference on Learning, Teaching and Educational Leadership - WCLTA 2012*, Izmir, Turkey, 2012.

- [244] J. Musulin, *Metodološki okvir dizajna usluge za osmišljavanje poslovnog modela obogaćenog konceptom korisničkog iskustva*, Varaždin, Croatia: Faculty of Organization and Informatics, 2021.
- [245] E. Souza, S. Abrahão, A. Moreira, J. Araújo and E. Insfran, "Comparing Value-Driven Methods: an experiment design," in *CEUR Workshop Proceedings*, Saint-Malo, France, 2016.
- [246] J. Zdravkovic and T. Ilayperuma, "Exploring REA and Open-edi Business Frameworks for Service Modeling," in *CAiSE 2010 Workshop BUSITAL'10*, Hammamet, Tunisia, 2010.
- [247] E. Souza, S. Abrahão, A. Moreira, E. Insfran and J. Araújo, "Evaluating the efficacy of value-driven methods: a controlled experiment," in *Conference: 26th International Conference on Information Systems Development (ISD 2017)*, Larnaca, Cyprus, 2017.
- [248] I. O. f. Standardization, "<https://www.iso.org>," 1987. [Online]. Available: <https://www.iso.org/obp/ui/#iso:std:iso:tr:9007:ed-1:v1:en>. [Accessed 8 November 2020].
- [249] O. Gerbe, G. W. Mineau and R. K. Keller, "Conceptual Graphs and Metamodeling," in *ICCS 2001: Conceptual Structures: Broadening the Base*, Stanford, 2001.
- [250] D. Allemang and J. Hendler, "Expert modeling in OWL," in *Semantic Web for the Working Ontologist- Effective Modeling in RDFS and OWL*, Burlington, Morgan Kaufmann Publishers, 2011, pp. 325-333.
- [251] g. Booch, J. Rumbaugh and I. Jacobson, *Unified Modeling Language User Guide, The (2nd Edition) (Addison-Wesley Object Technology Series)*, Massachusetts: Addison-Wesley Professional, 2005.
- [252] OMG, "About MOF," October 2019. [Online]. Available: <https://www.omg.org/spec/MOF/About-MOF/>.
- [253] D. Karagiannis and H. Kuhn, "Metamodelling Platforms," in *Proceedings of the Third International Conference EC-Web 2002- Dexa 2002*, Aix-en-Provence, 2002.
- [254] E. Souza, A. Moreira and F. Wanderley, "Towards an Agile Reference Architecture Method for Information Systems," in *Proceedings of the 51st Hawaii International Conference on System Sciences*, Big Island, Hawaii, 2018.
- [255] OMG, "About OMG," n.d.. [Online]. Available: <https://www.omg.org/about/index.htm>. [Accessed 17 11 2020].
- [256] L. Fuentes-Fernández and A. Vallecillo-Moreno, "An Introduction to UML Profiles," *The European Journal for the Informatics Professions*, vol. V, no. 2, pp. 6-13, 2004.
- [257] S. Friedenthal, A. Moore and R. Steiner, "A Brief Review of Metamodeling Concepts," in *Practical Guide to SysML*, Waltham, The MK/OMG Press, 2008, pp. 335-356.

- [258] J. F. Sowa, "Ontology," 29 11 2010. [Online]. Available: <http://www.jfsowa.com/ontology/>. [Accessed 5 3 2022].
- [259] M. M. Kokar, "ONTOLOGIES AND METAMODELING: APPLICATIONS TO POLICY BASED RADIO CONTROL," in *Software Defined Radio Technical Conference, SDR'06.* , Orlando, Florida, 2006.
- [260] I. Horrocks, P. F. Patel-Schneider and F. van Harmelen, "From SHIQ and RDF to OWL: The Making of a Web Ontology Language," *Journal of Web Semantics*, vol. 1, no. 1, pp. 7-26, 2013.
- [261] U. Aßmann, S. Zschaler and G. Wagner, "Ontologies, Meta-Models, and the Model-Driven Paradigm," *Ontologies for Software Engineering and Software Technology* , pp. 249-273, 2006.
- [262] C. M. Keet, *Closed World Assumption*, New York: Springer, 2013.
- [263] M.-N. Terrasse, M. Savonnet, E. Leclercq, G. Becker and T. Grison, "Do We Need Metamodels AND Ontologies for Engineering Platforms?," in *GAMMA '06: Proceedings of the 2006 international workshop on Global integrated model management*, Shanghai China, 2006.
- [264] T. O. Group, "TOGAF® Series Guide: Value Streams," The Open Group, Berkshire, United Kingdom, 2017.
- [265] VDMbee, "Purpose of VDML," 2020. [Online]. Available: <https://www.vdmbee.com/2015/02/purpose-vdml/>. [Accessed 5 12 2021].
- [266] G. H. Watson, "Peter F. Drucker:Delivering Value to Customers," *Measuring Business Excellence*, vol. 6, no. 4, pp. 55-61, 2002.
- [267] E. Iannitto, "The Customer Value: A Bibliographical Review," *International Journal of Marketing Studies*, vol. 11, no. 3, pp. 106-115, 2019.
- [268] J. C. Anderson and J. A. Narus, "Business MArketing: Understand What CUstomers Value," *Harward Business Review*, vol. 76, no. 6, pp. 5-15, 1998.
- [269] P. Liu, "Research on Customer Value Measurement," in *Proceedings of the 6th International Conference on Financial Innovation and*, College park, Maryland, United States, 2021.
- [270] E. C. Da Silva, "Customer Experience Project: A Framework to Create and Deliver Value to Customers," *International Journal of Marketing Studies*, vol. 13, no. 3, pp. 21-37, 2021.
- [271] S. Joshi, B. Sanjay, R. Kiran and A. Rohan, "Towards greater customer experience: Role of network parameters on key business drivers," *ARPN Journal of Engineering and Applied Sciences*, vol. 10, no. 3, pp. 2037-2046, 2015.
- [272] T. I. o. V. Management, "www.ivm.org.uk," The Institute of Value Management, 2021. [Online]. Available: <https://ivm.org.uk/value-management/>. [Accessed 8 11 2021].

- [273] BSI, "www.webstore.ansi.org," 2020. [Online]. Available: [https://webstore.ansi.org/preview-pages/BSI/preview\\_30314082.pdf](https://webstore.ansi.org/preview-pages/BSI/preview_30314082.pdf). [Accessed 8 11 2021].
- [274] E. Souzaa, A. Moreira, J. Araujo, S. Abrahao, E. Insfran and D. S. da Silveira, "Comparing Business Value Modeling Methods: A Family of Experiments," *Information and Software Technology*, vol. 104, pp. 179-193, 2018.
- [275] E. Comission, "www.ec.europa.eu/digital-single-market/en/reports-and-studies/76256/76256," [Online]. Available: <https://ec.europa.eu/digital-single-market/en/reports-and-studies/76256/76256>. [Accessed 11 6 2020].
- [276] J.-Q. Veronica, L. Muñoz-Gonzalez and B. Soria, "On the value of knowledge," *ournal of the European Association for Health Information and Libraries*, vol. 12, no. 3, pp. 4-6, 2016.
- [277] TVE, "www.thevalueengineers.nl/," The Value Engineers, 2021. [Online]. Available: <https://www.thevalueengineers.nl/#>. [Accessed 31 10 2021].
- [278] A. Wegmann, "ON THE SYSTEMIC ENTERPRISE ARCHITECTURE METHODOLOGY (SEAM)," in *International Conference on Enterprise Information Systems 2003 (ICEIS 2003)*, Angers - France, 2003.
- [279] B. Pirelli, J. Gordijn, G. Regev and A. Wegmann, "Comparison of Two Value-Modeling Methods: e3value and SEAM," in *2019 13th International Conference on Research Challenges in Information Science (RCIS)*, Brussels, Belgium, 2019.
- [280] A. Wegmann, A. Kotsalainen, L. Matthey, G. Regev and A. Giannattasio, "Augmenting the Zachman Enterprise Architecture Framework with a Systemic Conceptualization," in *2008 12th International IEEE Enterprise Distributed Object Computing Conference*, NW Washington, DCUnited States, 2008.
- [281] W. P. R. Laurier and G. Poels, "Track and Trace Future, Present, and Past Product and Money Flows with a Resource-Event-Agent Model," *Information Systems Management*, vol. 29, pp. 123-136, 2012.
- [282] W. E. Mccarthy, "The REA Accounting Model: A Generalized Framework for Accounting Systems Shared Data Environment," *The Accounting Review*, vol. LVII, no. 3, pp. 554-578, 1982.
- [283] I. O. f. Standardization, "www.iso.org," ISO, 11 2007. [Online]. Available: <https://www.iso.org/standard/40348.html>. [Accessed 1 11 2021].
- [284] J. Gordijn, H. Akkermans and H. van Vliet, "What's in an electronic business model?," in *Knowledge Engineering and Knowledge Management Methods, Models, and Tools. EKAW 2000. Lecture Notes in Computer Science*, Berlin, Germany, 2000.
- [285] K. O'Hara and N. Shadbolt, "Issues for an Ontology for Knowledge Valuation," in *Proceedings of the IJCAI-01 Workshop on E-Business and the Intelligent Web*, Seattle, USA, 2001.



- [286] M. Uschold, M. King, S. Moralee and Y. Zorgios, "www.aiai.ed.ac.uk/project/oplan/documents/1998," 1997. [Online]. Available: <http://www.aiai.ed.ac.uk/project/oplan/documents/1998/98-ker-ent-ontology.pdf>. [Accessed 11 11 2021].
- [287] M. S. Fox, "The TOVE Project Towards a Common-Sense Model of the Enterprise," in *Conference: Industrial and Engineering Applications of Artificial Intelligence and Expert Systems, 5th International Conference, IEA/AIE - 92*, Paderborn, Germany, 1992.
- [288] W. Chungyalpa, B. Bora and S. Borah, "Business Model Ontology (BMO): An Examination, Analysis, and Evaluation," *Journal of Entrepreneurship and Management*, vol. 5, no. 1, pp. 58-67, 2016.
- [289] R. Schuster and T. Motal, "From e3-value to REA: Modeling multi-party eBusiness Collaborations," in *Proceedings of the IEEE International Conference on Commerce and Enterprise Computing (CEC 2009)*, Vienna, Austria, 2009.
- [290] A. Osterwalder and Y. Pigneur, "An e-Business Model Ontology for Modeling e-Business," in *15th Bled Electronic Commerce Conference*, Bled, Slovenia, 2002.
- [291] D. W. Norton and J. B. Pine II, "Using the customer journey to road test and refine the business model," *Strategy and Leadership*, vol. 41, no. 2, pp. 12-17, 2013.
- [292] F. Dalpiaz, X. Franch and J. Horkoff, "iStar 2.0 Language Guide," 2016. [Online]. Available: <https://arxiv.org/pdf/1605.07767.pdf>. [Accessed 13 11 2021].
- [293] J. Gordijn, E. Yu and B. van der Raadt, "e-Service Design Using i\* and e3," *IEEE Software*, vol. 23, no. 3, pp. 26-33, 2006.
- [294] "www.cin.ufpe.br," UFPE and UFRPE, [Online]. Available: <https://www.cin.ufpe.br/~jhcp/pistar/>. [Accessed 13 11 2021].
- [295] "dit.unitn.it," University of Trento, [Online]. Available: [http://dit.unitn.it/~ft/ft\\_tool.html](http://dit.unitn.it/~ft/ft_tool.html). [Accessed 13 11 2011].
- [296] "www.cs.toronto.edu," University of Toronto, CANADA, 2000. [Online]. Available: <http://www.cs.toronto.edu/km/ome/>. [Accessed 13 11 2021].
- [297] A. A. Group, "www.arcweb.com," ARC Advisory Group, 2021. [Online]. Available: <https://www.arcweb.com/industry-concepts/collaborative-value-networks-cvn-concept#:~:text=Collaborative%20Value%20Networks%20%28CVN%29%20Concept%20In%20the%20coming,Networks%20Concept%20helps%20all%20parties%20to%20collaborate%20seamlessly..> [Accessed 24 11 2021].
- [298] L. M. Camarinha-Matos and H. Afsarmanesh, "COLLABORATIVE NETWORKS Value creation in a knowledge society," in *Proceedings of PROLAMAT 2006, IFIP Int. Conf. On Knowledge Enterprise – New Challenges*, Shanghai, China, 2006.

- [299] C. Bremer, R. C. Azevedo and A. P. Klen, "An Alignment Model for Collaborative Value Networks," in *Leveraging Knowledge for Innovation in Collaborative Networks, 10th IFIP WG 5.5 Working Conference on Virtual Enterprises, PRO-VE 2009*, Thessaloniki, Greece, 2009.
- [300] J. Tafur, M. Palacios and C. Casanueva, "Collaborative Value Network: Real cases of industry collaboration," in *International Conference on Industrial Engineering & Industrial Management - CIO 2007*, Madrid, Spain, 2007.
- [301] A. Bouras, P. Gouvas, D. Kourtesis and G. Mentzas, "SEMANTIC INTEGRATION OF BUSINESS APPLICATIONS ACROSS COLLABORATIVE VALUE NETWORKS," in *Working Conference on Virtual Enterprises*, Boston, USA, 2007.
- [302] Eclipse, "www.eclipse.org," Eclipse Foundation, Inc., [Online]. Available: <https://www.eclipse.org/epsilon/doc/eugenia/>. [Accessed 10 11 2021].
- [303] OMiLAB, "www.bee-up.omilab.org/activities/bee-up/," OMiLAB, 2021. [Online]. Available: <https://bee-up.omilab.org/activities/bee-up/>. [Accessed 10 10 2021].
- [304] OMILAB, "www.omilab.org/adoxx/," OMILAB NPO, 2021. [Online]. Available: <https://www.omilab.org/adoxx/>. [Accessed 24 11 2021].
- [305] ADOxx, "www.adoxx.org/live/home," [Online]. Available: <https://www.adoxx.org/live/home>. [Accessed 24 11 2021].
- [306] D. Bork , D. Karagiannis and B. Pittl, "How are Metamodels Specified in Practice? Empirical Insights and Recommendations," in *Twenty-fourth Americas Conference on Information Systems (AMCIS)*, New Orleans, 2018.
- [307] G. Booch, J. Rumbaugh and I. Jacobson, *The Unified Modeling Language User Guide*, Redwood City: Addison Wesley, 1998.
- [308] "UML 2001: A Standardization Odyssey," *COMMUNICATIONS OF THE ACM*, vol. 42, no. 10, pp. 29-37, 1999.
- [309] L. Fuentes-Fernández a and A. Vallecillo-Moreno, "An Introduction to UML Profiles," *The European Journal for the Informatics Professional*, vol. V, no. 2, pp. 6-13, 2004.
- [310] M. Pankowska, "Business Models in CMMN, DMN and ArchiMate language," *Procedia Computer Science*, vol. 164 , p. 11–18, 2019.
- [311] G. Poels, B. Roelens, H. de Man and T. van Donge, "Continuous Business Model Planning with the Value Management Platform," in *CEUR Workshop Proceedings*, Amsterdam, 2019.
- [312] V. Paradigm, "Pricing," Visual Paradigm, 2021. [Online]. Available: <https://online.visual-paradigm.com/>. [Accessed 31 12 2021].
- [313] VDMbee, "vdmbee.com/home-new/vdmbee-value-management-platform/vdmbee-business-model-canvas/," VDMbee, 2020. [Online]. Available: <https://vdmbee.com/home->

- new/vdmbee-value-management-platform/vdmbee-business-model-canvases/. [Accessed 11 7 2021].
- [314] VDMbee, "DMbee Business Model Canvases," VDMbee, 2020. [Online]. Available: <https://vdmbee.com/home-new/vdmbee-value-management-platform/vdmbee-business-model-canvases/>. [Accessed 10 7 2021].
- [315] A. Osterwalder, "Building Blocks of Business Model Canvas," Strategyzer AG, 2019. [Online]. Available: <https://www.strategyzer.com/business-model-canvas/building-blocks>. [Accessed 27 2 2022].
- [316] H. Hauksson and P. Johannesson, "Metamodeling for Business Model Design; Facilitating development and communication of Business Model Canvas (BMC) models with an OMG standards-based metamodel," 4 2 2016. [Online]. Available: <https://www.uio.no/studier/emner/matnat/ifi/INF5120/v16/ressurser/lectures/bmc-metamodel.pdf>. [Accessed 6 1 2022].
- [317] W. Schladofsky, J. Mitic, A. P. Megner, C. Simonato, L. Gioppo, D. Leonardos and A. Bröring, "Business Models for Interoperable IoT Ecosystems," in *Interoperability and Open-Source Solutions for the Internet of Things. Second International Workshop, InterOSS-IoT 2016*, Stuttgart, Germany, 2016.
- [318] C. F. Institute, "What is Value Network Analysis?," CFI Education Inc., 2022. [Online]. Available: <https://corporatefinanceinstitute.com/resources/knowledge/strategy/value-network-analysis/>. [Accessed 27 2 2022].
- [319] R. L. Fallon and S. Polovina, "Automated REA (AREA): A Software Toolset for a Machine-readable Resource-Event-Agent (REA) Ontology Specification," in *Conceptual Structures Tools and Interoperability Workshop 2016, Co-located at the 22nd International Conference on Conceptual Structures (ICCS 2016)*, Annecy, France, 2016.
- [320] T. O. Group, "The TOGAF® Standard, Version 9.2 Overview Reference Cards," 2018. [Online]. Available: <https://publications.opengroup.org/downloadable/download/link/id/MC4wOTg4MjEwMCAxNjM4Njg5MTI1MTIwNDYyMDEyMzlyODk4OTU%2C/>. [Accessed 5 12 2021].
- [321] T. M. Org, "Togaf Modeling," [Online]. Available: <https://www.togaf-modeling.org/>. [Accessed 5 12 2021].
- [322] P. Beauvoir and J.-B. Sarrodie, "www.archimatetool.com," The Open Group, 2021. [Online]. Available: <https://www.archimatetool.com/>. [Accessed 1 11 2021].
- [323] Modeliosoft, "Modelio," 2021. [Online]. Available: <https://www.modelio.org/>. [Accessed 5 12 2021].

- [324] H. Weigand, B. Andersson, P. Johannesson, M. Bergholtz and J. J. Arachchige, "Describing Coordination Services with REA," in *22nd International Conference on Advanced Information Systems Engineering*, Hammamet, Tunisia, 2010.
- [325] Z. Melis, J. Zacek and F. Hunka, "Metamodel of the REA model level," *Tem Journal*, vol. 2, no. 3, pp. 218-223, 2013.
- [326] VdmBee, "VDML roots: Resources Events Agents (REA)," VdmBee, 24 7 2014. [Online]. Available: <https://vdmbee.com/2014/07/vdml-roots-resources-events-agents-rea/#>. [Accessed 6 1 2022].
- [327] T. V. Engineers, "How to model and analyze a value model," The Value Engineers BV, 2022. [Online]. Available: <https://www.thevalueengineers.nl/tutorials/model-analyze-value-model/>. [Accessed 5 1 2022].
- [328] C. Huemer, A. Schmidt, H. Werthener and M. Zapletal, "A UML Profile for the e3-Value e-Business Model Ontology," in *3rd International Workshop on Business/IT Alignment and Interoperability (BUSITAL) at 20th International Conference on Advanced Information Systems Engineering (CAISE'08)*, Montpellier, France, 2008.
- [329] J. Gordijn, "E3value tool," 18 10 2019. [Online]. Available: <https://www.thevalueengineers.nl/download/e3value-tool/>. [Accessed 6 1 2022].
- [330] A. Rasiwasia, "Meta Modeling for Business Model Design: Designing a Meta model for E3 value model based on MOF," 2013. [Online]. Available: <http://www.diva-portal.org/smash/get/diva2:612576/FULLTEXT01.pdf>. [Accessed 6 1 2022].
- [331] VDMbee, "Purpose of VDML," VDMbee, 4 2 2015. [Online]. Available: <https://vdmbee.com/2015/02/purpose-vdml/>. [Accessed 8 1 2021].
- [332] H. and I. Snehota, "No business is an island: The network concept of The network concept of business strategy," *Sandinavian Journal of Management*, vol. 22, p. 256–270, 2006.
- [333] CARSA, "Specialised business support services for preparing European Digital Innovation Hubs (EDIHs)," 2021. [Online]. Available: <https://carsa.es/specialised-business-support-services-for-preparing-european-digital-innovation-hubs-edih/?lang=en>. [Accessed 19 11 2022].
- [334] E. Commission, "www.s3platform.jrc.ec.europa.eu," [Online]. Available: [https://s3platform.jrc.ec.europa.eu/digital-innovation-hubs-tool/-/dih/1152/view?\\_eu\\_europa\\_ec\\_jrc\\_dih\\_web\\_DihWebPortlet\\_backUrl=%2Fdigital-innovation-hubs-tool](https://s3platform.jrc.ec.europa.eu/digital-innovation-hubs-tool/-/dih/1152/view?_eu_europa_ec_jrc_dih_web_DihWebPortlet_backUrl=%2Fdigital-innovation-hubs-tool). [Accessed 11 2 2023].
- [335] "www.eit.europa.eu," EIT, 2023. [Online]. Available: <https://eit.europa.eu/our-activities/eit-regional-innovation-scheme>. [Accessed 14 2 2023].
- [336] "www.eit.europa.eu," EIT, 2023. [Online]. Available: <https://eit.europa.eu/our-activities/global-outreach>. [Accessed 14 2 2023].

- [337] EIT, "www.go-eit.eu," Webstack.agency, 2023. [Online]. Available: <https://go-eit.eu/eit-israel-hub/>. [Accessed 14 2 2023].
- [338] "www.go-eit.eu," Webstack.agency, 2023. [Online]. Available: <https://go-eit.eu/eit-israel-hub/our-community/#our-community>. [Accessed 14 2 2023].
- [339] "www.go-eit.eu," Webstack.agency, 2023. [Online]. Available: <https://go-eit.eu/eit-israel-hub/our-programmes/>. [Accessed 14 2 2023].
- [340] "www.go-eit.eu," Webstack.agency, 2023. [Online]. Available: <https://go-eit.eu/eit-silicon-valley-hub/our-programmes/#programmes>. [Accessed 15 2 2023].
- [341] "www.go-eit.eu," Webstack.agency, 2023. [Online]. Available: <https://go-eit.eu/eit-silicon-valley-hub/our-community/>. [Accessed 15 2 2023].
- [342] "www.go-eit.eu," Webstack.agency, 2023. [Online]. Available: (<https://go-eit.eu/eit-silicon-valley-hub/our-programmes/#programmes> . [Accessed 15 2 2023].
- [343] "www.go-eit.eu," Webstack.agency, 2023. [Online]. Available: <https://go-eit.eu/eit-silicon-valley-hub/who-we-are/#about-us>. [Accessed 15 2 2023].
- [344] E. Commission, "DIHELP- DIH enhanced Learning Programme," 1 2019. [Online]. Available: [http://dihelp.eu/wp-content/uploads/2019/01/DIHELP\\_Guide-for-Applicants\\_updated.pdf](http://dihelp.eu/wp-content/uploads/2019/01/DIHELP_Guide-for-Applicants_updated.pdf). [Accessed 1 2 2020].
- [345] E. Commission, "EU Budget for the Future," 2018. [Online]. Available: [file:///G:/FOI/09%20Pregled%20literature%20za%20disertaciju/digi/KI0118587ENN.en%20\(2\).pdf](file:///G:/FOI/09%20Pregled%20literature%20za%20disertaciju/digi/KI0118587ENN.en%20(2).pdf). [Accessed 1 2 2020].
- [346] E. Commission, "Roundtable on Digitising European Industry , WG1, Digital Innovation Hubs: Mainstreaming Digital Innovation Across All Sectors," Commission, European, Bruxelles, 2017.
- [347] V. R. Hrvatske, *Strategija poticanja inovacija Republike Hrvatske 2014. -2020.*, Zagreb: Vlada Republike Hrvatske, 2014.
- [348] V. R. Hrvatske, *Strategija pametne specijalizacije Republike Hrvatske za razdoblje od 2016. do 2020. godine i akcijski plan za provedbu strategije pametne specijalizacije Republike Hrvatske za razdoblje od 2016. do 2017. godine*, Zagreb: Vlada Republike Hrvatske, 2016.
- [349] A.-. A. z. r. V. zupanije, *Zupanijska razvojna strategija Varazdinske zupanije 2011.-2013.*, Varazdin, 2010.
- [350] *Županijska razvojna strategija Požeško-slavonske županije 2017.-2020.*, Pozega, 2017.
- [351] N. Peric, H. Domitrovic, M. Grgic and D. Petrinovic, *Strategija razvoja Fakulteta elektrotehnike i racunarstva Sveucilista u Zagrebu 2013.-2017.*, 2012: Sveučilište u Zagrebu Fakultet elektrotehnike i računarstva, Zagreb.

- [352] M. Ranga and L. Garzik, "From Mozart to Schumpeter: A Triple Helix System approach for enhancing innovation in the Salzburg region of Austria From Mozart to Schumpeter: A Triple Helix System approach for enhancing innovation in the Salzburg region of Austria," in *Designing the future: economic, societal and political dimensions of innovation*, Vienna, Echomedia Buchverlag, 2015, pp. 244-301.
- [353] E. Todeva and M. Danson, "Regional Dimensions of the Triple Helix Model," *Industry and Higher Level Education*, vol. 30, no. 1, p. 5–11, 2016.
- [354] H. Balzer and J. Askonas, "The Triple Helix after communism: Russia and China compared," *Triple Helix*, vol. 3, no. 1, 2016.
- [355] R. Secondo and G. Calabrese, "Triple helix in Italy: from national to regional approach," in *5th Triple helix conference*, Turin, 2005.
- [356] I. F. Obregon, *Towards a S3 strategy for: The Basque Country*, Seville: Basque Government, 2012.
- [357] T. J. Post, "RI, Netherlands enters new phase of triple helix collaboration," *The Jakarta Post*, Jakarta, 2014.
- [358] VDMbee, "vdmbee.com," VDMbee, [Online]. Available: <https://vdmbee.com/>. [Accessed 12 6 2021].
- [359] VDMbee, "vdmbee.com," [Online]. Available: <https://vdmbee.com/home-new/vdmbee-value-management-platform/>. [Accessed 12 6 2021].
- [360] VDMbee, "vdmbee.com," [Online]. Available: <https://vdmbee.com/home-new/vdmbee-value-management-platform/vdmbee-business-model-canvas/#businessCanvasBMC>. [Accessed 12 6 2021].
- [361] VDMbee, "vdmbee.com/home-new/vdmbee-value-management-platform/," VDMbee, 2020. [Online]. Available: <https://vdmbee.com/home-new/vdmbee-value-management-platform/>. [Accessed 11 7 2021].
- [362] VDMbee, "Value Management Platform to monitor and improve Business performance," 2020. [Online]. Available: <https://vdmbee.com/>. [Accessed 1 15 2020].
- [363] VDMbee, "VDMbee Value Management Platform," 2020. [Online]. Available: <https://vdmbee.com/home-new/vdmbee-value-management-platform/>. [Accessed 15 1 2020].
- [364] VDMbee, "VDMbee Value Stream Map," 2020. [Online]. Available: <https://vdmbee.com/home-new/vdmbee-value-management-platform/vdmbee-value-stream-map/>. [Accessed 15 1 2020].

- [365] VDMbee, "VDMbee Business Model Canvases," 2020. [Online]. Available: <https://vdmbee.com/home-new/vdmbee-value-management-platform/vdmbee-business-model-canvas/#businessCanvasesBMC>. [Accessed 15 1 2020].
- [366] G. Risola, J. Sörvik and J. Miörner, "Publications Office of the European Union," 24 9 2019. [Online]. Available: <https://op.europa.eu/en/publication-detail/-/publication/666fbb10-df40-11e9-9c4e-01aa75ed71a1/language-en>. [Accessed 4 12 2021].
- [367] A. Osterwalder, *THE BUSINESS MODEL ONTOLOGY A PROPOSITION IN A DESIGN SCIENCE APPROACH*, Lausanne, Switzerland: Organisation (DPIO) de l'Ecole des HEC de l'Université de Lausanne, 2004.
- [368] S. AG, "How do I use the Key Partnerships building block of the Business Model Canvas?," Strategyzer AG, 2019. [Online]. Available: <https://www.strategyzer.com/business-model-canvas/key-partnerships>. [Accessed 27 2 2022].
- [369] tutor2u, "Balanced Scorecard (Kaplan & Norton)," Tutor2u Limited, 18 2 2018. [Online]. Available: <https://www.tutor2u.net/business/reference/balanced-scorecard-introduction-overview>. [Accessed 23 5 2022].
- [370] a. S. M. G. c. Balanced Scorecard Institute, "Balanced Scorecard Basics," Balanced Scorecard Institute, a Strategy Management Group company, 2022. [Online]. Available: <https://balancedscorecard.org/bsc-basics-overview/>. [Accessed 23 5 2022].
- [371] Strategyzer AG, "Your Value Proposition describes the bundle of products and services that create value for a specific Customer Segment.," Strategyzer AG, 2019. [Online]. Available: <https://www.strategyzer.com/business-model-canvas/value-propositions>. [Accessed 5 2 2023].

## 10. APPENDIX

### Appendix 1: List of Abbreviations

ADM - Architecture Development Method

AI - Artificial Intelligence

AIAI EO - AIAI Enterprise Ontology

BMC - Business Model Canvas

BMC- Business Model Cube

BMO - Business Model Ontology

BPMN - Business Process Model and Notation

CAD - Computer-Aided Design

CEO - Chief Executive Officer

COP - Code of Practice

CPS - Cyber Physical Systems

CRC - Collaborative Research Centre

CRC - Cooperative research Center

CRM - Customer Relationship Management

CVN - Collaborative Value Networks

DEP - Digital Europe Programme

DIH RMM - DIH referent metamodel

DIH - Digital Innovation Hub

DG - Directorate General

DK - Design Knowledge



DSR - Design Science Research

DT - Digital Transformation

DTA - Digital Transformation Accelerator

DVD - Dynamic Value Description

EA - Enterprise Architecture

EAP - Enterprise Architecture Profile

EC - European Commission

EC - Entrepreneurship Center

EDIH - European DIH

EDT- Emerging and Disruptive Technology

EIT - European Institutes of Knowledge and Technology

EIT RIS - EIT Regional Innovation Scheme

EPO - European Patent Office

ERC - Entrepreneurship Research Center

ERDF - European Regional Development Fund

ERP - Enterprise Resource Planning

FDI - Foreign Direct Investment

FTE - Funding per one Researcher

GMF - Graphical Modelling Framework

HEIs - Higher Education Institutions

HPC - High Performance Computing

HR - Human Resources

i\* - iStar

ICT - Information and Communication Technology

IoT - Internet of Things

IP - Intellectual Property

IS - Information Systems

ISO - International Organization for Standardization

IT - Information Technology

IUCRC - Industry-University Cooperative Research Center

JRC - Joint Research Centre

KPI - Key Performance Indicator

KT - Knowledge Transfer

KTO - Knowledge Transfer Office

MOF - Meta-Object Facility

NtK - Need to Knowledge

OeBTO - Open-edi Business Transaction Ontology

OME - Organization Modelling Environment

OMG - Object Management Group

PI - Principal Investigator

PRI - Public Research Institute

QH - Quadruple Helix

R&D - Research and Development

REA - Resource- Event- Agent

RTO - Research and Technology Organization

S3 - Smart Specialization Strategy

SEAM - Systemic Enterprise Architecture Methodology

SME - Small and Medium-sized Enterprises

SMTE - Small and Medium Technological Enterprise

TH - Triple Helix

TOVE - Toronto Virtual Enterprise Ontology

TRL - Technology Readiness Level

TT - Technology Transfer

TTA - Technology Transfer Alliance

TTC - TT and commercialization

TTO - Technology Transfer Office

UI - University-Industry

UIC - University- Industry Collaboration

UIL - University-Industry Linkage

UIO - University Innovation Office

UI - University Incubator

UKTO - University Knowledge Transfer Office

UML - Unified Modeling Language

USUI - University–Start-Up Interaction

UTEN - University Technology Enterprise Network

UTTBM - University Technology Transfer Business Model

UTTO - University Knowledge Transfer Office

UTTO - University Technology Transfer Office

VAT - Value Added Tax

VD - Value Delivery

VDD - Value-Driven Development Method

VDMbee - Value Delivery Modeling by Business Enterprise Engineering

VDML - Value Delivery Modeling Language

VDS - Value Delivery System

VDSM - VDS Model

VNA - Value Network Analysis

## Appendix 2: List of Tables

Table 1. Conceptual Mapping Table. ....	15
Table 2. DIH Value Stream Example #1. ....	119
Table 3. DIH Value Stream Example #2. ....	123
Table 4. DIH Value Stream Example #3. ....	127
Table 5. DIH Value Stream Example #4. ....	130
Table 6. DIH Value Stream Example #5. ....	134
Table 7. List of Claims in the First Part of Interviewing Process. Source: Interviewees. ....	156
Table 8. List of Claims in the Second Part of Interviewing Process. Source: Interviewees. ....	161
Table 9. List of Claims Pertaining to EDIHs. Source: Interviewees. ....	170
Table 10. List of Focus Group Claims. Source: Interviewees. ....	191
Table 11. Factors Influencing DIHs and EDIHs with examples. Source: Author’s conclusion derived from mostly expert literature. ....	196
Table 12. Factors Causing Problems with intermediaries in KT processes from research community to industry and vice versa. ....	197
Table 13. Factors impacting intermediaries in KT processes from research community to industry and vice versa recognized in literature. ....	198
Table 14. Factors impacting intermediaries in TT processes from research community to industry and vice versa recognized in literature. ....	201
Table 15. Factors impacting DIHs and EDIHs with examples, recognized during practical part of the research. Source: Authors own conclusion and practical part of the research. ...	202
Table 16. Intermediaries in KT and TT from research community to industry and vice versa and their functions. ....	203
Table 17. DIH and EDIH functions. ....	204
Table 18. Novel information gathered and implications on M0, and M1/1 DIH VDML representations. ....	207
Table 19. Conceptual Mapping VDML - DIH Literature Source #1. ....	222
Table 20. Value and Value Proposition. ....	224
Table 21. Business Items. ....	227
Table 22. Capability. ....	228

Table 23. Conceptual Mapping VDML - DIH Literature Source #1.....	278
Table 24. Conceptual Mapping VDML - DIH Literature Source #2.....	279
Table 25. Conceptual Mapping VDML - DIH Literature Source #3.....	281
Table 26. Conceptual Mapping VDML - DIH Literature Source #4.....	283
Table 27. Conceptual Mapping VDML - DIH Literature Source #5.....	284
Table 28. Conceptual Mapping VDML - DIH Literature Source #6.....	286
Table 29. Conceptual Mapping VDML - DIH Literature Source #7.....	287
Table 30. Conceptual Mapping VDML - DIH Literature Source #8.....	288
Table 31. Conceptual Mapping VDML - Business Model Canvas – DIH.....	290
Table 32. Conceptual Mapping VDML - VNA - DIH.....	292
Table 33. Conceptual Mapping VDML - REA - DIH.....	296
Table 34. Conceptual Mapping VDML - e3value - DIH.....	300
Table 35. Conceptual Mapping VDML - Business Model Cube - DIH.....	304

## Appendix 3: Tables

Table 23. below contains information gathered through conceptual mapping between VDML and DIH concepts found in literature source #1. It is based on [19] and [25].

Table 23. Conceptual Mapping VDML - DIH Literature Source #1.

VDML concepts	Lit source 1 [25]	Lit source 1 comments
<b>ValueDeliveryModel (7.2.3.1.1)</b>	<b>DIH Metamodel 1</b>	
<b>VdmlElement (7.2.4.1.1)</b>	<b>DIH Metamodel all elements</b>	Abstract class
<b>MeasurableElement (7.2.4.1.4)</b>	for example: number of companies, partners, research institutions...	
<b>Attributes (7.2.4.1.2)</b>	for example, specialization of DIH	
<b>Annotation (7.2.4.1.3)</b>	for example, region in which DIH operates	
<b>MeasuredCharacteristic (7.2.4.1.5)</b>	for example, size, strength, level of digitalization	
<b>PortContainer (7.2.4.3.4)</b>	<p>-Educating [25, p. 5] ,</p> <p>-As the source states: training, skill developing, business advising, helping with business plans, supporting scale-up and internationalization, matching new firms with customers, testing and validating, attracting funding for financing DIH activities [25, p. 18].</p> <p>-Inherent conclusion from the source: instructors, teachers, speakers, subject matter experts, matchmaking officer/broker, database, data lakes, coordinator, point of contact, liaison officer, engineers, funds, financial resources, advisors, researchers, mentors, teachers, coaches, consultants Micro- and small enterprises, Medium-sized enterprises, Mid-caps, large companies [25, p. 21].</p> <p>-As the source states: Regional cluster organizations, Cluster organizations from other regions, regional government, Chambers of commerce, Trade associations, Enterprise Europe Network (EEN) local..., Innovation support organizations, Incubators, Vocational training organizations, Funding organizations, National government, Investors [25, p. 31].</p> <p>-As the source states (Internal human capital): Internal skills (employed/affiliated), Universities within DIH consortium, Business actors within the DIH, Public actors within the DIH consortium, Business actors within the DIH consortium [25, p. 28].</p> <p>-As the source states (external human capital): Other DIHs outside the region, Universities within the region (not part of DIH) Universities outside the region, Business actors within the region (not part of DIH), Business actors outside the region, Business actors within the region (not part of DIH), Public actors outside the region, Public actors within the region (not part of DIH), Other DIHs within the region, other DIHs outside the region [25, p. 28].</p>	List all written under “Activities”, “Stores” and “Collaborations”
<b>Collaboration (7.2.1.1.3)</b>	"Micro- and small enterprises, Medium-sized enterprises, Mid-caps, Large companies (DIH customers)" [25, p. 21]	
<b>Role (7.2.1.1.5)</b>	Investor [25, p. 24]	Investor is “Role”, not “Collaboration”
<b>RoleDefinition (7.2.5.5.2)</b>	Investor invest resources into... Matchmaker (a person or a system) matches appropriate actors	
<b>RoleLibrary (7.2.5.5.1)</b>	Investor is a financial entity investing resources into... Matchmaker is an intermediary entity (a person or a system) matching appropriate actors	
<b>RoleCategory (7.2.5.5.3)</b>	financial entities intermediary entities	
<b>Participant (7.2.1.1.4)</b>	Author’s own conclusion (in a DIH or project): Universities within DIH consortium, Business actors within the DIH, Public actors within the DIH consortium, Business actors within the DIH consortium; External human capital: Other DIHs outside the region [25, p. 28].	
<b>Actor (7.2.1.1.1)</b>	Author’s own conclusion: in a DIH or project- platform for e-learning, project manager, communication officer, partners, library database, etc.	

<b>Person (7.2.1.1.2)</b>	Author's own conclusion: in a DIH or project- project manager (who is a specific person), communication officer (also a specific person), all the partners (all of them specific persons) etc.	
<b>Assignment (7.2.1.2.3)</b>	Author's own conclusion: in a DIH or project- meeting participation, webinar participation	
<b>OrgUnit (7.2.2.3.1)</b>	Author's own conclusion: in a DIH or project- Department, Testbed environments, Task force	
<b>Position (7.2.2.3.2)</b>	Author's own conclusion: in a DIH or project- department head, testbed head engineer, task force head	
<b>Community (7.2.2.2.1)</b>	"Micro- and small enterprises, Medium-sized enterprises, Mid-caps, large companies" [25, p. 21]	
<b>Member (7.2.2.2.2)</b>	Inherent conclusion "within DIH enterprise and company individual employees, especially the ones on executive positions making business decisions" [25, p. 21]	
<b>BusinessNetwork (7.2.2.1.1)</b>	-As the source states: Regional cluster organizations, Cluster organizations from other regions, Regional government, Chambers of commerce, Trade associations, Enterprise Europé Network (EEN) local (...), Innovation support organizations, Incubators, Vocational training organizations, Funding organizations, National government, Investors [25, p. 24].  -As the source states, external human capital is: Other DIHs outside the region, Universities within the region (not part of DIH) Universities outside the region, Business actors within the region (not part of DIH), Business actors outside the region, Business actors within the region (not part of DIH, Public actors outside the region, Public actors within the region (not part of DIH), Other DIHs within the region, Other DIHs outside the region [25, p. 28].	-BN is collaboration of "Party" [19, p. 14], -Community is collaboration of "Participants" [19, p. 45]
<b>Party (7.2.2.1.2)</b>	Inherent conclusion: regional clusters, Governments, Chambers of Commerce, Trade Associations, members of Enterprise Europé Network (EEN), Innovation support organizations, Incubators, vocational training organizations, funding organizations, Investors [25, p. 24].  -Inherent conclusion: "other DIHs, Universities not in DIH, Business actors not in DIH, Public actors not in DIH" [25, p. 28].	(i.e., legal advice provider, knowledge provider, technology provider, funding provider...)
<b>7.1.2 Value and Value Proposition</b>	TT [25, p. 2]	
<b>7.1.9 Activity</b>	educating [25, p. 5], internationalization [25, p. 18] -As the source states: training, skill developing, business advising, helping with business plans, supporting scale-up and internationalization, matching new firms with customers, testing and validating, attracting funding for financing DIH activities [25, p. 18].	Matching new firms with customers- is activity, and matchmaking is collaboration
<b>7.1.11 Resources and Stores</b>	Inherent conclusion: instructors, teachers, speakers, subject matter experts, matchmaking "officer"/broker, database, data lakes, coordinator, point of contact, liaison "officer", engineers, funds, financial resources, advisors, researchers, mentors, teachers, coaches, consultants	

Table 24. below contains information gathered through conceptual mapping between VDML and DIH concepts found in literature source #2. It is based on [19] and [114].

Table 24. Conceptual Mapping VDML - DIH Literature Source #2.

<b>VDML concepts</b>	<b>Lit source 2 [114]</b>	<b>Lit source 2 comments</b>
<b>ValueDeliveryModel (7.2.3.1.1)</b>	<b>DIH Metamodel 2</b>	
<b>VdmlElement (7.2.4.1.1)</b>	<b>DIH Metamodel all elements</b>	Abstract class
<b>MeasurableElement (7.2.4.1.4)</b>	for example: number of companies, partners, research institutions...	
<b>Attributes (7.2.4.1.2)</b>	"Finnish DIHs" [114, p. 22] "manufacturing DIH (discrete, process, electronics), mobility DIH, health DIH, digital technologies DIH" [114, p. 23]	
<b>Annotation (7.2.4.1.3)</b>	"DIHs in the DEP" [114, p. 19], "DIH supported in HEU" [114, p. 20], "European digital Innovation Hub (EDIH)" [114, p. 21]	DIHs in DEP or HEU, EDIH could maybe also be 'Attribute'
<b>MeasuredCharacteristic (7.2.4.1.5)</b>	for example: size, strength, level of digitalization	



<b>PortContainer (7.2.4.3.4)</b>	“Training, skill developing, supporting finding finance, networking, connecting” [114, p. 16], -Inherent conclusion: instructors, teachers, speakers, subject matter experts, matchmaking officer/broker, database, data lakes, coordinator, point of contact, liaison "officer", engineers, funds, financial resources, advisors, researchers, mentors, teachers, coaches, consultants (...) Incubators, research organizations, start-ups, SMEs, large companies, industry associations, governments [114, p. 15].	All under Activities, Stores and Collaborations
<b>Collaboration (7.2.1.1.3)</b>	“Incubators, research organizations, start-ups, SMEs, large companies, industry associations, governments” [114, p. 15]	
<b>Role (7.2.1.1.5)</b>	-“Knowledge/tech provider, Knowledge/tech recipient (recipient)” [114, p. 28], -Inherent conclusion: Policy creator (enabler), Funding recipient (recipient)	
<b>RoleDefinition (7.2.5.5.2)</b>	“Infrastructure provider (DIH tangible role)” [114, p. 18]	
<b>RoleLibrary (7.2.5.5.1)</b>	Knowledge/tech provider is an entity providing knowledge/tech Knowledge/tech recipient is an entity receiving Knowledge/tech policy creator is a policy making entity which provides policy funding receiver is an entity receiving funding, funding recipient infrastructure provider provides infrastructure to be used	
<b>RoleCategory (7.2.5.5.3)</b>	Providers, recipients	
<b>Participant (7.2.1.1.4)</b>	-“SMEs, universities of applied sciences, vocation schools” [114, p. 23], -“LUKE, VTT, TTY-SAATIO, Hermia Yrityksenkehitys Oy, Kine Robots Solutions Oy, Visual Components Oy” [114, p. 39]	
<b>Actor (7.2.1.1.1)</b>	Author’s own conclusion: in a DIH or project- platform for e-learning, project manager, communication officer, partners, library database, etc.	
<b>Person (7.2.1.1.2)</b>	Author’s own conclusion: in a DIH or project- project manager (who is a specific person), communication officer (also a specific person), all the partners (all of them specific persons) etc.	
<b>Assignment (7.2.1.2.3)</b>	For example, in a DIH or project: meeting participation, webinar participation	
<b>OrgUnit (7.2.2.3.1)</b>	For example, in a DIH or project: Department, Testbed environments, Task force	
<b>Position (7.2.2.3.2)</b>	For example, in a DIH or project: department head, testbed head engineer, task force head	
<b>Community (7.2.2.2.1)</b>	“Incubators, research organizations, start-ups, SMEs, large companies” [114, p. 15]	Incubator is Community and a Party
<b>Member (7.2.2.2.2)</b>	Inherent conclusion: “individual employees working in incubators, research organizations, start-ups, SMEs, and large companies” [114, p. 15].	
<b>BusinessNetwork (7.2.2.1.1)</b>	“industry associations, governments, investors” [114, p. 15]	
<b>Party (7.2.2.1.2)</b>	Inherent conclusion: “Industries in particular industry associations, governments, investors” [114, p. 15].	(i.e., legal advice provider, knowledge provider, technology provider, funding provider...)
<b>7.1.2 Value and Value Proposition</b>	-As the source states: coordination of actions, trust building, long-term commitment, enhanced skills development and SME participation, bridging the gap to traditionally non-digital value chains [114, p. 25].  -“diffusion of knowledge” [114, p. 7]	
<b>7.1.9 Activity</b>	-“training, skill developing, supporting finding finance, networking, connecting” [114, p. 16]	Matching new firms with customers- is activity, and matchmaking is collaboration
<b>7.1.11 Resources and Stores</b>	Inherent conclusion: instructors, teachers, speakers, subject matter experts, matchmaking "officer"/broker, database, data lakes, coordinator, point of contact, liaison "officer", engineers, funds, financial resources, advisors, researchers, mentors, teachers, coaches, consultants	

Table 25. below contains information gathered through conceptual mapping between VDML and DIH concepts found in literature source #3. It is based on [19] and [113].

Table 25. Conceptual Mapping VDML - DIH Literature Source #3.

VDML concepts	Lit source 3 [113]	Lit source 3 comments
<b>ValueDeliveryModel (7.2.3.1.1)</b>	<b>DIH Metamodel 3</b>	
<b>VdmlElement (7.2.4.1.1)</b>	<b>DIH Metamodel all elements</b>	<b>Abstract class</b>
<b>MeasurableElement (7.2.4.1.4)</b>	for example: number of companies, partners, research institutions...	
<b>Attributes (7.2.4.1.2)</b>	for example, specialization of DIH	
<b>Annotation (7.2.4.1.3)</b>		
<b>MeasuredCharacteristic (7.2.4.1.5)</b>	for example, region in which DIH operates	
<b>PortContainer (7.2.4.3.4)</b>	<p>-As the source states:  Test before invest, Skills and training to make the most of digital innovations, Support to find investments, Creation of an innovation ecosystem and networking opportunities through marketplaces and brokerage activities” [113, p. 1].</p> <p>-training, “experimentation and testbed activities, assisting ventures or initiatives seeking funding, and ecosystem-building” [113, p. 8]  -“uptake and implementation of specific key technologies, such as artificial intelligence or eHealth” [113, p. 8]  -“ecosystem development” [113, p. 8]  -“providing digitalization services [113, p. 8]  -matchmaking and testbed activities” [113, p. 45]  -“improving the matching between sides and adding new sides to the platform” [113, p. 45],  -“organizing open innovation workshops” [113, p. 45]  -“Map needs and incentives” [113, p. 45]  -“Design matching mechanisms” [113, p. 46]  -“Grow gradually” [113, p. 46]  -“Data-driven analysis and experimentation” [113, p. 46]  -“Grow through expansion” [113, p. 46]  -“expanding DIH-to-DIH” [113, p. 46]  -“bridging a fragmented system with many parallel support organizations and frameworks” [113, p. 46]  -“training and skill-development” [113, p. 46]  -“ecosystem-building” [113, p. 46]</p> <p>-“Horizon Europe Programme; Digital Europe Programme; hub networking” [113, p. 1]  -“Smart Specialization Strategies (RIS3) [113, p. 2]  -“Digital Europe Programme (DEP)” [113, p. 3]  -“regional/national smart specialization strategy (S3)” [113, p. 4]</p> <p>- As the source states:  DIH catalogue tool (serving both the purpose of gathering data on the DIHs that exist in Europe and advancing DIH interconnection and interactions across regions; today, it is a repository serving as yellow pages with more than 280 DIHs, including information on the technology and application specialization, geographical coverage, market focus and digitalization support available) [113, p. 4].</p> <p>-“ERDF funding, H2020 and national research funding” [113, p. 5]  -“Digital Single Market (DSM)” [113, p. 7]  -“DIHs acting as network organizations” [113, p. 8]  -“multi-stakeholder entrepreneurial discovery process (EDP)” [113, p. 8]  -“European Regional Development Fund (ERDF)” [113, p. 10]</p> <p>-Inherent conclusion: instructors, teachers, speakers, subject matter experts, matchmaking "officer"/broker, database, data lakes, coordinator, point of contact, liaison "officer", engineers, funds, financial resources, advisors, researchers, mentors, teachers, coaches, consultants</p>	All under Activities, Stores (resources and stores) and Collaborations
<b>Collaboration (7.2.1.1.3)</b>	As the source states: Horizon Europe Programme (Supporting experiments where highly innovative companies work together with Digital Innovation Hubs to develop novel digital solutions to improve their businesses); Digital Europe Programme (Investing in capacity building of hubs in all regions of Europe ensuring appropriate uptake of Artificial Intelligence, High Performance Computing and Cybersecurity by all industry and public sector organizations in Europe); hub networking (to ensure transfer of	incentives [113, p. 45]

	<p>expertise enabling specialization and excellence, and avoiding a digital divide) [113, p. 1].</p> <p>-“Smart Specialization Strategies (RIS3)” [113, p. 2]  -“Digital Europe Programme (DEP)” [113, p. 3]  -“regional/national smart specialization strategy (S3)” [113, p. 4]</p> <p>-As the source states:  DIH catalogue tool (serving both the purpose of gathering data on the DIHs that exist in Europe and advancing DIH interconnection and interactions across regions; today, it is a repository serving as yellow pages with more than 280 DIHs, including information on the technology and application specialization, geographical coverage, market focus and digitalization support available) [113, p. 4].</p> <p>- “ERDF funding, H2020 and national research funding” [113, p. 5]  - “Digital Single Market (DSM)” [113, p. 7]</p> <p>- As the source states:  DIHs acting as network organizations (bringing together different types of actors, including organizations like universities, companies, industry associations, chambers of commerce, incubator and accelerators, regional development agencies and even governmental organizations) [113, p. 8].</p> <p>-“multi-stakeholder entrepreneurial discovery process (EDP)” [113, p. 8]  -“European Regional Development Fund (ERDF)” [113, p. 10]</p>	
<b>Role (7.2.1.1.5)</b>		
<b>RoleDefinition (7.2.5.5.2)</b>		
<b>RoleLibrary (7.2.5.5.1)</b>		
<b>RoleCategory (7.2.5.5.3)</b>		
<b>Participant (7.2.1.1.4)</b>	-for example, in a DIH or project: universities, companies, industry associations, chambers of commerce, incubator and accelerators, regional development agencies and even governmental organizations [113, p. 8].	
<b>Actor (7.2.1.1.1)</b>	-“companies, esp. SMEs and midcaps, and public sector organizations” [113, p. 1] -“DIH managers and regional policy managers” [113, p. 3] -“representatives from the private sector” [113, p. 11], -“business leaders” [113, p. 37] -“academic research, start-ups, established firms, established (non-digital) firms, innovative start-ups, start-ups with support system actors, system actor, researchers” [113, p. 45] -“universities, companies, industry associations, chambers of commerce, incubator and accelerators, regional development agencies and even governmental organizations” [113, p. 8]	
<b>Person (7.2.1.1.2)</b>	-“DIH managers and regional policy managers” [113, p. 3] -“representatives from the private sector” [113, p. 11] -business leaders [113, p. 37] -researchers [113, p. 45]	
<b>Assignment (7.2.1.2.3)</b>	For example, in a DIH or project: meeting participation, webinar participation	
<b>OrgUnit (7.2.2.3.1)</b>	For example, in a DIH or project: Department, Testbed environments, Task force	
<b>Position (7.2.2.3.2)</b>	For example, in a DIH or project: department head, testbed head engineer, task force head	
<b>Community (7.2.2.2.1)</b>	multi-sided platforms [113, p. 3]	
<b>Member (7.2.2.2.2)</b>		
<b>BusinessNetwork (7.2.2.1.1)</b>		
<b>Party (7.2.2.1.2)</b>		
<b>7.1.2 Value and Value Proposition</b>	-“improvement of processes, products and services through digital technologies; supporting organizations in their digital transformation” [113, p. 1] -Digital maturity [113, p. 4]	
	- As the source states: balance between supporting basic and general forms of digitalization efforts aimed at existing industries, and at the same time promoting the development of cutting-edge technological solutions in a niche of the market [113, p. 5].	

7.1.9 Activity	<p>- As the source states: Test before invest, Skills and training to make the most of digital innovations, Support to find investments, Creation of an innovation ecosystem and networking opportunities through marketplaces and brokerage activities [113, p. 1].</p> <p>-“training, experimentation and testbed activities, assisting ventures or initiatives seeking funding, and ecosystem-building” [113, p. 8] -“uptake and implementation of specific key technologies, such as artificial intelligence or eHealth” [113, p. 8] -“ecosystem development” [113, p. 8] -“providing digitalization services” [113, p. 8] -“matchmaking and testbed activities” [113, p. 45] -“improving the matching between sides and adding new sides to the platform” [113, p. 45] -“organizing open innovation workshops” [113, p. 45] -“Map needs and incentives” [113, p. 45] -“Design matching mechanisms” [113, p. 46] -“Gradual growth” [113, p. 46] -“Data-driven analysis and experimentation” [113, p. 46] -“Grow through expansion” [113, p. 46] -“expanding DIH-to-DIH” [113, p. 46] -“bridging a fragmented system with many parallel support organizations and frameworks” [113, p. 46] -“training and skill-development” [113, p. 46] -“ecosystem-building” [113, p. 46]</p>	“balance regional, national and global collaborations” [113, p. 48]
7.1.11 Resources and Stores	Inherent conclusion: instructors, teachers, speakers, subject matter experts, matchmaking "officer"/broker, database, data lakes, coordinator, point of contact, liaison "officer", engineers, funds, financial resources, advisors, researchers, mentors, teachers, coaches, consultants	

Table 26. below contains information gathered through conceptual mapping between VDML and DIH concepts found in literature source #4. It is based on [19] and [24].

Table 26. Conceptual Mapping VDML - DIH Literature Source #4.

VDML concepts	"Lit source 4 [24]	Lit source 4 comments
ValueDeliveryModel (7.2.3.1.1)	DIH Metamodel 4	
VdmlElement (7.2.4.1.1)	DIH Metamodel all elements	Abstract class
MeasurableElement (7.2.4.1.4)	for example: number of companies, partners, research institutions...	
Attributes (7.2.4.1.2)	for example, specialization of DIH	
Annotation (7.2.4.1.3)	for example, region in which DIH operates	
MeasuredCharacteristic (7.2.4.1.5)	for example, size, strength, level of digitalization	
PortContainer (7.2.4.3.4)	<p>-“transforming innovative ideas into technologically feasible solutions” [24, p. 2] -“fostering knowledge exchange and sharing” [24, p. 2] -“creating an ecosystem” [24, p. 2] -“growing long-term relationships” [24, p. 7] -“network design and network management” [24, p. 7] -“managing the mobility of knowledge, appropriability of innovation as well as network stability” [24, p. 7] -“regular meetings and social events for both internal members and external parties in order to facilitate ideas and knowledge sharing” [24, p. 20] -“competition for funding” [24, p. 21] -acquiring talents [24, p. 21] -“effectively diffuse and adopting new knowledge developed elsewhere in order to accelerate further innovation within the innovation hub” [24, p. 23] -“available resources such as incubation and funding” [24, p. 24] -“innovation hubs act like a networked platform that blends a diverse range of competences” [24, p. 2]</p>	All under Activities, Stores and Collaborations

	-“high degree of open collaboration, knowledge sharing and the creation of collective intelligence” [24, p. 20] -“industry collaboration” [24, p. 25] -“networks and resources that improve innovation processes (what make up the networks are companies with a diverse range of competences)” [24, p. 20]	
<b>Collaboration (7.2.1.1.3)</b>	-“Innovation hubs act like a networked platform that blends a diverse range of competences” [24, p. 2] -“high degree of open collaboration, knowledge sharing and the creation of collective intelligence” [24, p. 20] -industry collaboration [24, p. 25] -“networks and resources that improve innovation processes (what make up the networks are companies with a diverse range of competences)” [24, p. 20]	
<b>Role (7.2.1.1.5)</b>	-“enabler of the connectivity of different companies to improve innovation processes, both internally within firms as well as to the network and geographical region in which they are located” [24, p. 1]	
<b>RoleDefinition (7.2.5.5.2)</b>		
<b>RoleLibrary (7.2.5.5.1)</b>		
<b>RoleCategory (7.2.5.5.3)</b>	initial entity (angel investor)	
<b>Participant (7.2.1.1.4)</b>		
<b>Actor (7.2.1.1.1)</b>	-“angel investors and venture capital” [24, p. 1]	
<b>Person (7.2.1.1.2)</b>		
<b>Assignment (7.2.1.2.3)</b>		
<b>OrgUnit (7.2.2.3.1)</b>		
<b>Position (7.2.2.3.2)</b>		
<b>Community (7.2.2.2.1)</b>		
<b>Member (7.2.2.2.2)</b>		
<b>BusinessNetwork (7.2.2.1.1)</b>		
<b>Party (7.2.2.1.2)</b>		
<b>7.1.2 Value and Value Proposition</b>	-“transfer of knowledge” [24, p. 6] -“network and ecosystem constituted by the innovation hub’s members as well as the extended network of the innovation hub” [24, p. 7] -“maximizing the innovation output of the network” [24, p. 7] -“ability to acquire and keep the right talent” [24, p. 16], -“extent of DIHs networks and resources that improve innovation processes (what make up the networks are companies with a diverse range of competences)” [24, p. 20]	
<b>7.1.9 Activity</b>	-“transforming innovative ideas into technologically feasible solutions” [24, p. 2] -“fostering knowledge exchange and sharing” [24, p. 2] -“creating an ecosystem” [24, p. 2] -“growing long-term relationships” [24, p. 7] -“network design and network management” [24, p. 7] -“managing the mobility of knowledge, appropriability of innovation as well as network stability” [24, p. 7] -“regular meetings and social events for both internal members and external parties in order to facilitate ideas and knowledge sharing” [24, p. 20] -“competition for funding” [24, p. 21] -acquiring talents [24, p. 21] -“effectively diffuse and adopting new knowledge developed elsewhere in order to accelerate further innovation within the innovation hub” [24, p. 23]	-As the source states: Building more supporting facilities in the community in order to attract young professional from other big cities [24, p. 22].
<b>7.1.11 Resources and Stores</b>	-available resources such as “incubation and funding” [24, p. 24]	

Table 27. below contains information gathered through conceptual mapping between VDML and DIH concepts found in literature source #5. It is based on [19] and [344].

Table 27. Conceptual Mapping VDML - DIH Literature Source #5.

VDML concepts	Lit source 5 [344]	Lit source 5 comments
---------------	--------------------	-----------------------

<b>ValueDeliveryModel (7.2.3.1.1)</b>	<b>DIH Metamodel 5</b>	
<b>VdmlElement (7.2.4.1.1)</b>	<b>DIH Metamodel all elements</b>	Abstract class
<b>MeasurableElement (7.2.4.1.4)</b>	for example: number of companies, partners, research institutions...	
<b>Attributes (7.2.4.1.2)</b>	for example, specialization of DIH	
<b>Annotation (7.2.4.1.3)</b>	for example, region in which DIH operates	
<b>MeasuredCharacteristic (7.2.4.1.5)</b>	for example, size, strength, level of digitalization	
<b>PortContainer (7.2.4.3.4)</b>	<p>-“Digitizing European Industry strategy (DEI initiative aims to ensure that any business in Europe has access to a Digital Innovation Hub at ‘a working distance’)” [344, p. 2]</p> <p>-As the source states: A DIH is a regional multi-partner cooperation (including organizations like RTOs, universities, industry associations, chambers of commerce, incubator/accelerators, regional development agencies and even governments) and can also have strong linkages with service providers outside of their region supporting companies with access to their services [344, p. 2].</p> <p>-“multi-partner cooperation” [344, p. 3]. -“collaboration of different regional actors working together to offer a set of technological and innovation services that the industry of the region needs to go through their digital transformation” [344, p. 4] -“coaching and mentoring Programme to Digital Innovation Hubs (DIHs); on business development, financing and innovation management delivered both face-to-face and remotely” [344, p. 2] -“provide access to the latest knowledge, expertise and technology to support their customers with piloting, testing and experimenting with digital innovations” [344, p. 2] -“business and financing support to implement these innovations, if needed across the value chain” [344, p. 2] -“Access to digital technologies and competences, Infrastructure and training to test digital innovations” [344, p. 2] -“Financing advice, Market intelligence, Networking opportunities, Access to digital skills development and training” [344, p. 3] -“experimentation and testing” [344, p. 3] -“training, brokering/matchmaking, visioning and strategy development, awareness creation, digital maturity assessment, innovation scouting, mentoring, fabrication of new products, innovation scouting” [344, p. 3] -“experimenting and testing digital innovations, help start-up companies to grow and scale” [344, p. 4]</p>	All under Activities, Stores and Collaborations
<b>Collaboration (7.2.1.1.3)</b>	<p>-“Digitizing European Industry strategy (DEI initiative aims to ensure that any business in Europe has access to a Digital Innovation Hub at ‘a working distance’)” [344, p. 2]</p> <p>-As the source states: A DIH is a regional multi-partner cooperation (including organizations like RTOs, universities, industry associations, chambers of commerce, incubator/accelerators, regional development agencies and even governments) and can also have strong linkages with service providers outside of their region supporting companies with access to their services [344, p. 2].</p> <p>-“multi-partner cooperation” [344, p. 3]. -“collaboration of different regional actors working together to offer a set of technological and innovation services that the industry of the region needs to go through their digital transformation” [344, p. 4]</p>	
<b>Role (7.2.1.1.5)</b>		
<b>RoleDefinition (7.2.5.5.2)</b>		
<b>RoleLibrary (7.2.5.5.1)</b>		
<b>RoleCategory (7.2.5.5.3)</b>		
<b>Participant (7.2.1.1.4)</b>	<p>-“technology infrastructure (competence center)” [344, p. 2] -“pilot factories, associations, SMEs, large industries, startups, fab-labs” [344, p. 3], “digital technologies, key enabling technologies” [344, p. 3] -“RTOs, universities, industry associations, chambers of commerce, incubator/accelerators, regional development agencies and even governments), service providers outside of their region” [344, p. 2]</p>	

<b>Actor (7.2.1.1.1)</b>	-“European industries in all EU Member States” [344, p. 2] -“every company, small or large, high-tech or not” [344, p. 2] -“coordinator of the DIH” [344, p. 4]  -As the source states: Technical universities and research and technology centers (RTOs), generally referred to as ‘competence centers’ (CCs) or ‘centers of competence’ (CoCs), Incubators and accelerators that, Cluster organizations and industry associations representing private sector companies, public administrations [344, p. 4].	
<b>Person (7.2.1.1.2)</b>	-“Coordinator of the DIH” [344, p. 4]	
<b>Assignment (7.2.1.2.3)</b>		
<b>OrgUnit (7.2.2.3.1)</b>		
<b>Position (7.2.2.3.2)</b>		
<b>Community (7.2.2.2.1)</b>		
<b>Member (7.2.2.2.2)</b>		
<b>BusinessNetwork (7.2.2.1.1)</b>		
<b>Party (7.2.2.1.2)</b>		
<b>7.1.2 Value and Value Proposition</b>	-“digital transformation of industry” [344, p. 2] -“to become more competitive” [344, p. 2] -“strengthen the innovation ecosystem” [344, p. 2] -“digital skills, digital and application expertise, access to finance” [344, p. 3]	
<b>7.1.9 Activity</b>		
<b>7.1.11 Resources and Stores</b>		

Table 28. below contains information gathered through conceptual mapping between VDML and DIH concepts found in literature source #6. It is based on [19] and [345].

Table 28. Conceptual Mapping VDML - DIH Literature Source #6.

<b>VDML concepts</b>	<b>"Lit source 6 [345]"</b>	<b>Lit source 6 comments</b>
<b>ValueDeliveryModel (7.2.3.1.1)</b>	<b>DIH Metamodel 6</b>	
<b>VdmlElement (7.2.4.1.1)</b>	<b>DIH Metamodel all elements</b>	Abstract class
<b>MeasurableElement (7.2.4.1.4)</b>	for example: number of companies, partners, research institutions...	
<b>Attributes (7.2.4.1.2)</b>	for example, specialization of DIH	
<b>Annotation (7.2.4.1.3)</b>		
<b>MeasuredCharacteristic (7.2.4.1.5)</b>	for example, region in which DIH operates	
<b>PortContainer (7.2.4.3.4)</b>	-As the source states: boosting investments in supercomputing, artificial intelligence, cybersecurity, advanced digital skills; Investing in and opening up the use of artificial intelligence by businesses and public administrations, Facilitating safe access to and storage of large sets of data and algorithms, Strengthening and support existing artificial intelligence testing and experimentation facilities in areas such as health and mobility in Member States and encouraging their cooperation [345, p. 1].  -As the source states: Supporting, together with Member States, the procurement of advanced cybersecurity equipment, tools and data infrastructures, Supporting the best use of European knowledge, capacity and advanced skills related to cybersecurity, Ensuring the wide deployment of the latest cybersecurity solutions across the economy, Reinforcing capabilities within Member States and the private sector for a uniformly high level of security of network and information systems across the EU, Supporting the design and delivery of short-term trainings and courses for entrepreneurs, small business leaders and the workforce, Supporting the design and delivery of long-term trainings and Master’s courses for students, IT professionals and the workforce, Supporting on-the-job trainings and traineeships for students, young entrepreneurs and graduates, Ensuring that the public sector and areas of public interests, such as health and care, education, transport, and the cultural and creative sectors, deploying and accessing state-of-the-art digital technologies, Providing more interoperable public services across the EU and at EU level, Offering public administrations access to testing and piloting of digital technologies, including their cross-	All under “Activities”, “Stores” and “Collaborations”

	border use, Supporting the uptake of advanced digital and related technologies by the industry, notably small and medium-sized enterprises, Building up and strengthening the network of European Digital Innovation Hubs, aiming to have a Hub in every region, helping companies benefit from digital opportunities, Supporting and following closely latest technical developments with the potential to benefit European economy and society” [345, p. 2].  -As the source states: Digital Europe Programme (EU’s Programme focused on building the strategic digital capacities of the EU and on facilitating the wide deployment of digital technologies, to be used by Europe’s citizens and businesses [345, p. 1].	
<b>Collaboration (7.2.1.1.3)</b>	-As the source states: Digital Europe Programme (EU’s Programme focused on building the strategic digital capacities of the EU and on facilitating the wide deployment of digital technologies, to be used by Europe’s citizens and businesses [345, p. 1].	
<b>Role (7.2.1.1.5)</b>		
<b>RoleDefinition (7.2.5.5.2)</b>		
<b>RoleLibrary (7.2.5.5.1)</b>		
<b>RoleCategory (7.2.5.5.3)</b>		
<b>Participant (7.2.1.1.4)</b>		
<b>Actor (7.2.1.1.1)</b>		
<b>Person (7.2.1.1.2)</b>		
<b>Assignment (7.2.1.2.3)</b>		
<b>OrgUnit (7.2.2.3.1)</b>		
<b>Position (7.2.2.3.2)</b>		
<b>Community (7.2.2.2.1)</b>		
<b>Member (7.2.2.2.2)</b>		
<b>BusinessNetwork (7.2.2.1.1)</b>		
<b>Party (7.2.2.1.2)</b>		
<b>7.1.2 Value and Value Proposition</b>	-As the source states: digital transformation of Europe’s society and economy, ensuring a wide use of digital technologies across the economy and society, improving Europe’s competitiveness in the global digital economy and increasing its technological autonomy, Building up and strengthen the EU’s supercomputing and data processing capacities by buying world-class exactable supercomputers by 2022/2023 and post exactable facilities by 2026/2027, Increasing accessibility and broadening the use of supercomputing in areas of public interest such as health, environment and security, and in industry, including small and medium-sized enterprises [345, p. 1].	
<b>7.1.9 Activity</b>	Inherent conclusion: investing	
<b>7.1.11 Resources and Stores</b>		

Table 29. below contains information gathered through conceptual mapping between VDML and DIH concepts found in literature source #7. It is based on [19] and [346].

Table 29. Conceptual Mapping VDML - DIH Literature Source #7.

<b>VDML concepts</b>	<b>Lit source 7 [346]</b>	<b>Lit source 7 comments</b>
<b>ValueDeliveryModel (7.2.3.1.1)</b>	<b>DIH Metamodel 7</b>	
<b>VdmlElement (7.2.4.1.1)</b>	<b>DIH Metamodel all elements</b>	Abstract class
<b>MeasurableElement (7.2.4.1.4)</b>	for example: number of companies, partners, research institutions...	
<b>Attributes (7.2.4.1.2)</b>	-As the source states: agile and demand-led, no one-fit-all approach, common values based on independence, commitment to excellence and customer service and proactive innovative approach (iv) The available services should complement rather than compete against existing public and private service offerings (iv) new and distinctive approach (iv) highly client-focused (iv) offer a broad range of services accessible through multiple entry points (iv) instill entrepreneurial thinking and embed a digital culture	



	in companies while being firmly rooted in practical business solutions (iV) strong physical presence while also operating effectively in the digital space, flexible business models that are able to adapt and evolve over time as circumstances and funding regimes change (iv) companies which currently have a relatively low level of digitization and which do not have the resources or personnel to address the digitization challenge [346, p. 8].	
<b>Annotation (7.2.4.1.3)</b>	for example, region in which DIH operates	
<b>MeasuredCharacteristic (7.2.4.1.5)</b>	for example, size, strength, level of digitalization	
<b>PortContainer (7.2.4.3.4)</b>	Too much content to be fitted here...	All under Activities, Stores and Collaborations
<b>Collaboration (7.2.1.1.3)</b>		
<b>Role (7.2.1.1.5)</b>		
<b>RoleDefinition (7.2.5.5.2)</b>		
<b>RoleLibrary (7.2.5.5.1)</b>		
<b>RoleCategory (7.2.5.5.3)</b>		
<b>Participant (7.2.1.1.4)</b>		
<b>Actor (7.2.1.1.1)</b>	-"incubators, research organizations, investors, SMEs, large companies, industry associations, governments, incubators" [346, p. 5]	
<b>Person (7.2.1.1.2)</b>		
<b>Assignment (7.2.1.2.3)</b>		
<b>OrgUnit (7.2.2.3.1)</b>		
<b>Position (7.2.2.3.2)</b>		
<b>Community (7.2.2.2.1)</b>		
<b>Member (7.2.2.2.2)</b>		
<b>BusinessNetwork (7.2.2.1.1)</b>		
<b>Party (7.2.2.1.2)</b>		
<b>7.1.2 Value and Value Proposition</b>	-“access to competence centers, development of innovation ecosystem, brokerage, access to finance, market intelligence, training and education, incubator/mentoring services” [346, p. 5] -As the source states: Speak the language of SME businesses and understand their needs; Market themselves and actively identify relevant customers for their services; Possess significant know-how in both technical areas and business management; Understand business models and business transformation and be able to help companies transform; Broker between the needs of industry and relevant technology providers in an independent and unbiased way; Work with companies at all levels of digital maturity, including offering low-tech transfer to companies lower down the maturity curve. Equip companies with the necessary skills, from technical training at various levels, to coaching and mentoring the workforce on how to deal efficiently with the newly digitised products, processes and business models. Provide a gateway to specialist platforms and infrastructures. Provide funding or facilitate access to funding from external sources [346, p. 16].	
<b>7.1.9 Activity</b>	-As the source states: Innovation activities, concerned with identifying opportunities for digitisation, and developing and validating innovative solutions based on cutting-edge technology; Business development, concerned with helping companies to apply their solutions, assess the business implications, and manage the resultant changes; and Skills creation, concerned with building innovation capacity through enriching human capital [346, p. 17].	
<b>7.1.11 Resources and Stores</b>		

Table 30. below contains information gathered through conceptual mapping between VDML and DIH concepts found in literature source #8. It is based on [19] and [116].

Table 30. Conceptual Mapping VDML - DIH Literature Source #8.

VDML concepts	Lit source 8 [116]	Lit source 8 comments
<b>ValueDeliveryModel (7.2.3.1.1)</b>	<b>DIH Metamodel 8</b>	
<b>VdmlElement (7.2.4.1.1)</b>	<b>DIH Metamodel all elements</b>	Abstract class

<b>MeasurableElement (7.2.4.1.4)</b>	for example: number of companies, partners, research institutions...	
<b>Attributes (7.2.4.1.2)</b>	for example, specialization of DIH	
<b>Annotation (7.2.4.1.3)</b>	for example, region in which DIH operates	
<b>MeasuredCharacteristic (7.2.4.1.5)</b>	for example, size, strength, level of digitalization	
<b>PortContainer (7.2.4.3.4)</b>	Too much content to fit here...	PortContainer -all under “Activities”, “Stores” and “Collaborations”
<b>Collaboration (7.2.1.1.3)</b>	-As the source states: Collaborative research projects, which is the case of few DIHs (e.g. Visual Sweden and PRODUTECH Norte). Wallonia’s DIH instead works with demonstrators, start-up boosters, specialised workshops, living labs, assistance to the development of research projects. Others try to stimulate R&I project initiation by mobilising partners to form consortia and apply for different calls, also helping out in writing national and EU funding applications (e.g. in East Sweden and Catalonia). Depending on the type of host organisation and partners the DIH counts with, technology solution implementation and/or support can be provided with internal resources or through partners, as well as using either off-the-shelf solutions or more customised ones [116, p. 16].	
<b>Role (7.2.1.1.5)</b>	-As the source states: One clear role of DIHs in many regions is to better organise the innovation support system in the region, and make available support easier to find by making the system more transparent and communicating it more clearly to potential beneficiaries. In many places the regional innovation ecosystem is complex, so it is useful to offer one-stop shops where a DIH help and guide SMEs through the innovation support system. [116, p. 23].	Can also be “Value and Value Proposition”
<b>RoleDefinition (7.2.5.5.2)</b>		
<b>RoleLibrary (7.2.5.5.1)</b>		
<b>RoleCategory (7.2.5.5.3)</b>		
<b>Participant (7.2.1.1.4)</b>	SMEs [116, p. 20]	
<b>Actor (7.2.1.1.1)</b>	-“clusters, research centres, training centres and professional federations” [116, p. 29]	
<b>Person (7.2.1.1.2)</b>		
<b>Assignment (7.2.1.2.3)</b>		
<b>OrgUnit (7.2.2.3.1)</b>		
<b>Position (7.2.2.3.2)</b>		
<b>Community (7.2.2.2.1)</b>		
<b>Member (7.2.2.2.2)</b>		
<b>BusinessNetwork (7.2.2.1.1)</b>		
<b>Party (7.2.2.1.2)</b>		
<b>7.1.2 Value and Value Proposition</b>	-As the source states: consolidating the community and invest in common projects while community members act in their specific interest and are not fully aware of the value of common projects; Maintaining companies’ independence while collaborating; Developing soft competences for DIH members; Creation of a self-assessment tool that would allow enterprise to prepare for digitization; Common strategy for different approaches of all the companies; One-stop-shop principle and its management; Selling services to potential customers, maturing their need of services [116, p. 39].	
<b>7.1.9 Activity</b>	-As the source states: Awareness raising, i.e., to promote the use of new technologies and DIH services (through activities such as roadshows, showrooms, events, workshops, interactive demonstrations, factory tours, videos, commercials, online and printed media). This is an important mission for DIHs, since highlighting the opportunities brought by digital transformation is essential to promote the expected upgrading of industry. And this is a task that all DIHs engage in, in some kind of form, either through direct contacts with potential beneficiaries or through marketing or public events. — Diagnosis, since most DIHs carry out analysis of the company’s specific needs and possible digital solutions to improve their competitiveness. This is done in different forms, one of the most common being an online maturity test where customer companies can carry out a self-assessment to prepare themselves before proceeding to work with the DIH. Some offer free consultancy time (shorter or longer) to identify needs, while others charge for more in-depth analysis. Some offer analysis for free and then charge for solutions, while others offer subsidised solutions as well.	

	<p>— A transformation plan, which is the outcome of the diagnosis and proposes possible technologies, new solutions or new business models to the analysed company. In effect, not all DIHs solely offer different forms of technological solutions but quite a few also connect these to new business model developments and innovation in the strategic direction of the company (e.g. in Baden-Württemberg and Wallonia).</p> <p>— Experimentation, testing, piloting</p> <p>Matchmaking, which is quite common and may refer to favoring the encounter between supply and demand, including universities and research institutes as providers, or less frequently between companies with similar needs or complementary solutions (which is closer to DIH ecosystem building role).</p> <p>— Training and skills development, which is also quite a common feature despite not provided being by every DIH (e.g. Wallonia's organises Digital Bootcamps, others like AFIL and LINPRA offer education and mentoring).</p> <p>— Promotion and marketing: some DIHs help companies to promote and market themselves (e.g. Wallonia's).</p> <p>— Internationalisation (e.g. Wallonia, Norte and South Moravian Hubs).</p> <p>— Financing, which is a common feature and consist of different ways to provide funding assistance for digitalisation activities, either by providing subsidise services or innovation vouchers to purchase services, but also facilitating contacts with venture capital and other types of investors. Additionally, a few keep track of and suggest opportunities with different forms of public innovation support calls.</p> <p>— Economic studies and analytical insights, both for private actors and the public sector (e.g. LINPRA in Lithuania).</p> <p>— Transversal initiatives to favor digitisation, e.g. the Walloon DIH is active in processes of developing and implementing the high-speed Internet infrastructure while at the same time it stimulates open innovation and the use of open data. [116, pp. 16-17].</p>	
<b>7.1.11 Resources and Stores</b>		

Table 31. below contains information gathered through conceptual mapping of VDML, Business Model Canvas and DIH concepts found in literature, based on [19], [117], and [11].

Table 31. Conceptual Mapping VDML - Business Model Canvas – DIH.

<b>VDML Concept</b>	<b>BMC Concept</b>	<b>Lit source 1 [117]</b>	<b>My Lit source 1 Comments</b>	<b>Lit source 2 [11]</b>	<b>My Lit source 2 Comments</b>
<b>Channel</b>	<b>Channel</b>	- for example: web/mobile/cloud, physical channel	- how is the product delivered to clients	- for example: web/mobile/cloud, physical channel	-how is the product delivered to clients
<b>Value contribution component (cost)</b>	<b>Cost Structure</b>	- for example, people, buildings, materials	- Costs to operate the business model... Fixed costs, variable costs, economy of scale...	-For example, people, buildings, materials	- Costs to operate the business model... Fixed costs, variable costs, economy of scale...
<b>Collaboration</b>	<b>Customer Relationships</b>	- for example: web page, social networks, web-caffes, webinars...	- How do I get, keep and grow customers	- for example: web page, social networks, web-caffes, webinars...	- How do I get, keep and grow customers

<b>Community</b>	<b>Customer Segment</b>	-As the source states: Micro- and small enterprises, Medium-sized enterprises, Mid-caps, Large companies [117, p. 21].	- “BN is a collaboration of parties”  -“Community is a collaboration of participants” [19, p. 45]  -“Research organization” can be “Customer Segment” and “Key Partner”	-As the source states: Incubators, start-ups, SMEs, large companies [11, p. 15].	- Incubator is “Community” and “Party”  - “BN is a collaboration of parties” [19, p. 14];  - “Community is a collaboration of participants” [19, p. 45]
<b>Capability Library</b>	<b>Key activities</b>	- educating [117, p. 5] - internationalization, [117, p. 18] - As the source states: training, skill developing, business advising, helping with business plans, supporting scale-up and internationalization, matching new firms with customers, testing and validating, attracting funding for financing DIH activities [117, p. 18].	-“Matching new firms with customers”- this is “activity”, and “matchmaking” is (according to this source) a ”collaboration”	- As the source states: training, skill developing, supporting finding finance, networking, connecting [11, p. 16]	“Matching new firms with customers”- this is “activity”, and “matchmaking” is (according to this source) a “collaboration”
<b>Business network</b>	<b>Key Partnerships</b>	- As the source states: Regional cluster organizations, Cluster organizations from other regions, regional government, Chambers of commerce, Trade associations, Enterprise Europé Network (EEN) local (...) Innovation support organizations, Incubators, Vocational training organizations, Funding organizations, National government, Investors [117, p. 24]. - As the source states, external human capital is: Other DIHs outside the region, Universities within the region (not part of DIH) Universities outside the region, Business actors within the region (not part of DIH), Business actors outside the region, Business actors within the region (not part of DIH, Public actors outside the region, public actors within the region (not part of DIH), Other DIHs within the region, Other DIHs outside the region [117, p. 28].	- “BN is collaboration of parties” [19, p. 14] - “Community is a collaboration of participants” [19, p. 45]	- As the source states: industry associations, governments, investors [11, p. 15].	- “BN is a collaboration of parties” [19, p. 14] – “Community is a collaboration of participants” [19, p. 45]
<b>Capability</b>	<b>Key resources</b>	Inherent conclusion: instructors, teachers, speakers, subject matter experts, matchmaking	- this is “Resources and Stores”	Inherent conclusion: instructors, teachers, speakers, subject matter experts,	- this is “Resources and Stores”

		"officer"/broker, database, data lakes, coordinator, point of contact, liaison "officer", engineers, funds, financial resources, advisors, researchers, mentors, teachers, coaches, consultants		matchmaking "officer"/broker, database, data lakes, coordinator, point of contact, liaison "officer", engineers, funds, financial resources, advisors, researchers, mentors, teachers, coaches, consultants	
<b>Business network</b>	<b>Revenue Streams</b>	-DIH is non-profit	- How do I make money selling my products and services to customer segments	DIH is non-profit	- How do I make money selling my products and services to customer segments
<b>Value Proposition</b>	<b>Value Proposition</b>	- TT [117, p. 2]	- this is "Value and Value Proposition"	- As the source states: coordination of actions, trust building, long-term commitment, enhanced skills development and SME participation, bridging the gap to traditionally non-digital value chains [11, p. 25].  - "diffusion of knowledge" [11, p. 7]	- TT [11, p. 2]  -This is "Value and Value Proposition"

Table 32. below contains information gathered through conceptual mapping of VDML, VNA and DIH concepts found in literature based on [19], [117], and [11].

Table 32. Conceptual Mapping VDML - VNA - DIH.

<b>VDML Concept</b>	<b>VNA Concept</b>	<b>DIH Lit Source 1 [117]</b>	<b>My Lit source 1 Comments</b>	<b>DIH Lit Source 2 [11]</b>	<b>My Lit source 2 Comments</b>
<b>Activity</b>	<b>Activity</b>	-educating [117, p. 5] -internationalization [117, p. 18]	Elements belonging to VDML Activity	-As the source states: training, skill developing,	Elements belonging to VDML Activity

		- As the source states: training, skill developing, business advising, helping with business plans, supporting scale-up and internationalization, matching new firms with customers, testing and validating, attracting funding for financing DIH activities [117, p. 18].	class found in this literature source  Matching new firms with customers- is activity, and “matchmaking” is a “collaboration”	supporting finding finance, networking, connecting [11, p. 16].	class found in this literature source  Matching new firms with customers- is “activity”, and “matchmaking” is a “collaboration”
<b>Attribute</b>	<b>Attribute</b>	-for example, specialization of DIH	Elements belonging to VDML Attribute class found in this literature source	-“Finnish DIHs” [11, p. 22]  -As the source states: manufacturing DIH (discrete, process, electronics), mobility DIH, health DIH, digital technologies DIH [11, p. 23].	Elements belonging to VDML Attribute class found in this literature source
<b>Channel</b>	<b>Channel</b>	-Inherent conclusion: face-to-face conversation, e-mail, telephone, VTC platform (i.e., Skype, Zoom, Adobe Connect), Fax	Elements belonging to VDML Activity class found in this literature source.	-Inherent conclusion: face-to-face conversation, e-mail, telephone, VTC platform (i.e., Skype, Zoom, Adobe Connect), Fax	Elements belonging to VDML Activity class found in this literature source.
<b>Deliverable</b>	<b>Deliverable</b>	-Inherent conclusion: lessons, display, advice, support, matching partner, test, validation, finance	Deduction from elements belonging to VDML Activity class found in this literature source.	-Inherent conclusion: lessons, skills, funding, connections	Elements belonging to VDML Activity class found in this literature source.
<b>Intangible</b>	<b>Intangible</b>	-Inherent conclusion: lessons, display, advice, support, matching partner, test, validation, finance	Deduction from elements belonging to VDML Activity class found in this literature source. Elements are the same as tangible ones, since DIH is non-profit. Deliverable, Tangible and Intangible elements are therefore the same.	-Inherent conclusion: lessons, skills, funding, connections	Elements belonging to VDML Activity class found in this literature source. Elements are the same as tangible ones, since DIH is non-profit. Deliverable, Tangible and Intangible elements are therefore the same.
<b>Measure</b>	<b>Measure</b>	-For example: level of DIH specialization	Deduction from elements belonging to VDML Attribute class found in this literature source.	As the source states: DIH nationality (EU or non-EU), DIH focus (manufacturing: discrete, process, electronics; mobility; health, digital technologies [11, p. 23].	Deduction from elements belonging to VDML Attribute class found in this literature source.
<b>Measurement</b>	<b>Measurement</b>	-For example, a scale	Deduction from elements belonging to VDML Attribute class found in this literature source.	-Inherent conclusion: list comparison, research community connection evaluation	Deduction from elements belonging to VDML Attribute class found in this literature source.
<b>Actor</b>	<b>Participant</b>	Author’s conclusion, in a DIH or project: platform for e-learning, project manager,	Elements belonging to VDML Actor	Author’s conclusion, in a DIH or project: platform for e-	Elements belonging to VDML Actor

		communication officer, partners, library database, etc.	class found in this literature source	learning, project manager, communication officer, partners, library database, etc.	class found in this literature source
<b>Participant</b>	<b>Participant</b>	For example, in a DIH or project: SMEs, incubators, partners	Elements belonging to VDML Participant class found in this literature source	As the source states: SMEs, universities of applied sciences, vocation schools" [11, p. 23], "LUKE, VTT, TTY-SAATIO, Hermia Yrityskehitys Oy, Kine Robots Solutions Oy, Visual Components Oy [11, p. 39].	Elements belonging to VDML Participant class found in this literature source
<b>Resource</b>	<b>Resource or Asset</b>	Inherent conclusion: instructors, teachers, speakers, subject matter experts, matchmaking "officer"/broker, database, data lakes, coordinator, point of contact, liaison "officer", engineers, funds, financial resources, advisors, researchers, mentors, teachers, coaches, consultants	Elements belonging to VDML Resources and Stores class found in this literature source	Inherent conclusion: instructors, teachers, speakers, subject matter experts, matchmaking "officer"/broker, database, data lakes, coordinator, point of contact, liaison "officer", engineers, funds, financial resources, advisors, researchers, mentors, teachers, coaches, consultants	Elements belonging to VDML Resources and Stores class found in this literature source
<b>Role</b>	<b>Role</b>	Investor [117, p. 24]	Elements belonging to VDML Role class found in this literature source	-As the source states: Knowledge/tech provider, Knowledge/tech recipient (recipient) [11, p. 28].  -Inherent conclusion: Policy creator (enabler), Funding recipient (recipient)	Elements belonging to VDML Role class found in this literature source
<b>Scenario</b>	<b>Scenario</b>	-different context of educating [117, p. 5] -different context of internationalization, [117, p. 18]  -different context of: training, skill developing, business advising, helping with business plans, supporting scale-up and internationalization, Matching new firms with customers, testing and validating, attracting funding for financing DIH activities [117, p. 18].  - As the source states, different context of: Micro- and small enterprises, Medium-sized enterprises, Mid-caps, Large companies (DIH customers) [117, p. 21].	Different context of elements belonging to VDML Activity class and Collaboration class found in this literature source  Matching new firms with customers- is activity, and matchmaking is collaboration	-different context of: training, skill developing, supporting finding finance, networking, connecting [11, p. 16].  -different context of: Incubators, research organizations, start-ups, SMEs, large companies, industry associations, governments [11, p. 15].	Different context of elements belonging to VDML Activity class and Collaboration class found in this literature source  Matching new firms with customers- is "activity", and matchmaking is a "collaboration"

<b>Tangible</b>	<b>Tangible</b>	-Inherent conclusion: lessons, display, advice, support, matching partner, test, validation, finance	Deduction from elements belonging to VDML Activity class found in this literature source. Elements are the same as tangible ones, since DIH is non-profit. Deliverable, Tangible and Intangible elements are therefore the same.	-Inherent conclusion: lessons, skills, funding, connections	Elements belonging to VDML Activity class found in this literature source. Elements are the same as tangible ones, since DIH is non-profit. Deliverable, Tangible and Intangible elements are therefore the same.
<b>Deliverable Flow</b>	<b>Transaction</b>	-Inherent conclusion-transfer of: lessons, display, advice, support, matching partner, test, validation, finance	Deduction from elements belonging to VDML Activity class found in this literature source.	-Inherent conclusion-transfer of: lessons, skills, funding, connections	Elements belonging to VDML Activity class found in this literature source.
<b>Value</b>	<b>Value</b>	TT [117, p. 2]	Elements belonging to VDML Value and Value Proposition class found in this literature source	As the source states: coordination of actions, trust building, long-term commitment, enhanced skills development and SME participation, bridging the gap to traditionally non-digital value chains [11, p. 25].  -“diffusion of knowledge” [11, p. 7]	Elements belonging to VDML Value and Value Proposition class found in this literature source
<b>Activity Network</b>	<b>Value Network</b>	-“network of educating” [117, p. 5] -“network of internationalization” [117, p. 18] - As the source states: network of “training, skill developing, business advising, helping with business plans, supporting scale-up and internationalization, matching new firms with customers, testing and validating, attracting funding for financing DIH activities [117, p. 18].	VDML specification states that it is a network of activities [19, p. 97]. So, it is a network of elements belonging to VDML Activity class found in this literature source. Matching new firms with customers- is activity, and matchmaking is collaboration	- As the source states: network of training, skill developing, supporting finding finance, networking, connecting [11, p. 16].	VDML specification states that it is a network of activities [19, p. 97]. So, it is a network of elements belonging to VDML Activity class found in this literature source  Matching new firms with customers- is “activity”, and matchmaking is a “collaboration”
<b>Collaboration</b>	<b>Value Network</b>	As the source states: Micro- and small enterprises, Medium-sized enterprises, Mid-caps, Large companies (DIH customers) [117, p. 21].	Elements belonging to VDML Collaboration class found in this literature source	-As the source states: Incubators, research organizations, start-ups, SMEs, large companies, industry associations, governments [11, p. 15].	Elements belonging to VDML Collaboration class found in this literature source
<b>Value Proposition</b>	<b>Value Realization</b>	TT [117, p. 2]	Elements belonging to VDML Value	As the source states: coordination of actions, trust	Elements belonging to



			and Value Proposition class found in this literature source	building, long-term commitment, enhanced skills development and SME participation, bridging the gap to traditionally non-digital value chains [11, p. 25].  -“diffusion of knowledge” [11, p. 7]	VDML Value and Value Proposition class found in this literature source
--	--	--	---	--	--

Table 33. below contains information gathered through conceptual mapping of VDML, REA and DIH concepts found in literature based on [19], [117], and [11].

Table 33. Conceptual Mapping VDML - REA - DIH.

VDML Concept	REA Concept	DIH Lit Source 1 [117]	My Lit source 1 Comments	DIH Lit Source 2 [11]	My Lit source 2 Comments
<b>Business network</b>	<b>Business process</b>	<p>-As the source states: Regional cluster organizations cooperation, cooperation with Cluster organizations from other regions, Regional Government, Chambers of commerce interaction, Trade associations interaction, Enterprise Europé Network (EEN) local (...) cooperation, Innovation support organizations cooperation, inclusion of Incubators, Vocational training organizations inclusion, Funding organizations participation, National government interaction, Investors' participation [117, p. 24].</p> <p>- As the source states (external human capital): Other DIHs outside the region, Universities within the region (not part of DIH) Universities outside the region, Business actors within the region (not part of DIH), Business actors outside the region, Business actors within the region (not part of DIH), Public actors outside the region, Public Actors within the region (not part of DIH), Other DIHs within the region, Other DIHs outside the region [117, p. 28].</p>	<p>-As the source states: All the same as Business Network VDML elements found in DIH lit source 1, with an accent on business processes (inherent conclusion) [19, p. 105].</p>	<p>- As the source states: industry associations interaction, governments interference, investors inclusion [11, p. 15].</p>	<p>-As the source states: All the same as Business Network VDML elements found in DIH lit source 2, with an accent on business processes (inherent conclusion) [19, p. 111].</p>
<b>Business network</b>	<b>Contract</b>	<p>-As the source states: contracts with regional cluster organizations, Cluster organizations from other regions, regional government, Chambers of commerce, Trade associations, Enterprise Europé Network (EEN) local (...), Innovation support organizations, Incubators, Vocational training organizations, Funding organizations, National government, Investors [117, p. 24].</p> <p>-As the source states (External human capital): Other DIHs outside the region, Universities within the region (not part of DIH) Universities</p>	<p>All the same as Business Network VDML elements found in DIH lit source 1, with an accent on contracts (inherent conclusion) [19, p. 111]</p>	<p>-As the source states: contracts with industry associations, governments, investors [11, p. 15].</p>	<p>All the same as Business Network VDML elements found in DIH lit source 2, with an accent on contracts (inherent conclusion) [19, p. 111]</p>

		outside the region, Business actors within the region (not part of DIH), Business actors outside the region, Business actors within the region (not part of DIH), Public actors outside the region, Public Actors within the region (not part of DIH), Other DIHs within the region, Other DIHs outside the region [117, p. 28].			
<b>Business network</b>	<b>Exchange</b>	<p>-As the source states: exchange with Regional Cluster Organizations, Cluster Organizations from other Regions, Regional Government, Chambers of commerce, Trade associations, Enterprise Europé Network (EEN) local..., Innovation support organizations, Incubators, Vocational training organizations, Funding organizations, National government, Investors [117, p. 28].</p> <p>-As the source states (exchange with External human capital): Other DIHs outside the region, Universities within the region (not part of DIH) Universities outside the region, Business actors within the region (not part of DIH), Business actors outside the region, Business actors within the region (not part of DIH), Public actors outside the region, Public Actors within the region (not part of DIH), Other DIHs within the region, Other DIHs outside the region” [117, p. 28].</p>	All the same as Business Network VDML elements found in DIH lit source 1, with an accent on exchange (inherent conclusion) [19, p. 111]	“exchange with industry associations, governments, investors” [11, p. 15]	All the same as Business Network VDML elements found in DIH lit source 2, with an accent on exchange (inherent conclusion) [19, p. 111]
<b>Value proposition</b>	<b>Commitment</b>	-TT [117, p. 2] -KT (inherent conclusion)		-As the source states: coordination of actions, trust building, long-term commitment, enhanced skills development and SME participation, bridging the gap to traditionally non-digital value chains [11, p. 25].  -“diffusion of knowledge” [11, p. 7]	
<b>Duality</b>	<b>Duality</b>	nil	In case of DIH-no, unless it is a case of matchmaking. The reason for that is that DIH is non-profit	nil	In case of DIH- no, unless it is a case of matchmaking. The reason for that is that DIH is non-profit
<b>Store or capability</b>	<b>Economic resource</b>	-Inherent conclusion: instructors, teachers, speakers, subject matter experts, matchmaking "officer"/broker, database, data lakes, coordinator, point of	The first part is from Resources and Stores class from VDML elements found in	-Inherent conclusion: instructors, teachers, speakers, subject matter	The first part is from Resources and Stores class from VDML elements found in DIH source 2. The

		<p>contact, liaison "officer", engineers, funds, financial resources, advisors, researchers, mentors, teachers, coaches, consultants</p> <p>-Inherent conclusion: internal KT, Internal skills, Internal Human Capital, Internal/External Infrastructure, External Human Capital, External Skills, External KT, Technical Infrastructure</p>	<p>DIH source 1. The second part is from M1 DIH cognitive level model storyline</p>	<p>experts, matchmaking "officer"/broker, database, data lakes, coordinator, point of contact, liaison "officer", engineers, funds, financial resources, advisors, researchers, mentors, teachers, coaches, consultants</p> <p>-Inherent conclusion: internal KT, Internal skills, Internal Human Capital, Internal/External Infrastructure, External Human Capital, External Skills, External KT, Technical Infrastructure</p>	<p>second part is from M1 DIH cognitive level model storyline</p>
<b>Party role (Business network)</b>	<b>Economic agent</b>	Investor [117, p. 24]	<p>-This is from Role class in VDML found in DIH literature source 1</p> <p>-Investor is a role (not collaboration)</p>	<p>-As the source states: Knowledge/tech provider, Knowledge/tech recipient (recipient) [11, p. 28].</p> <p>-Policy creator (enabler), Funding recipient (recipient)</p>	<p>-This is from Role class in VDML found in DIH literature source 2</p> <p>-Investor is a role (not collaboration)</p>
<b>Activity</b>	<b>Economic event</b>	<p>-educating [117, p. 5]</p> <p>-internationalization [117, p. 18]</p> <p>-As the source states: training, skill developing, business advising, helping with business plans, supporting scale-up and internationalization, matching new firms with customers, testing and validating, attracting funding for financing DIH activities [117, p. 18].</p>	<p>-Matching new firms with customers is an "activity", and according to this source matchmaking is "collaboration"</p>	<p>-As the source states: training, skill developing, supporting finding finance, networking, connecting [11, p. 16].</p>	<p>-Matching new firms with customers is an activity, and according to this source matchmaking is collaboration</p>
<b>Capability method or practice</b>	<b>Policy</b>	Inherent conclusion: different S3		Inherent conclusion: different S3	
<b>Deliverable flow (Role)</b>	<b>Provide and Receive</b>	Investor [117, p. 24]; so, for example deliverable flow between Investor and Client	<p>-Investor is from Role class in VDML found in DIH literature source 1</p> <p>-Investor is a role (not collaboration)</p>	<p>-As the source states: Knowledge/tech provider, Knowledge/tech recipient (recipient") [11, p. 28].</p> <p>So, for example deliverable flow between them</p> <p>-Policy creator (enabler), Funding</p>	<p>-These elements are from Role class in VDML found in DIH literature source 2</p> <p>-Investor is a role (not collaboration)</p>

				recipient (recipient); so, for example deliverable flow between those two	
<b>Deliverable flow (Store)</b>	<b>Stockflow</b>	<p>-Inherent conclusion; a deliverable flow between: instructors, teachers, speakers, subject matter experts, matchmaking "officer"/broker, database, data lakes, coordinator, point of contact, liaison "officer", engineers, funds, financial resources, advisors, researchers, mentors, teachers, coaches, consultants</p> <p>-Inherent conclusion; a deliverable flow between: internal KT, Internal skills, Internal Human Capital, Internal/External Infrastructure, External Human Capital, External Skills, External KT, Technical Infrastructure</p>	<p>The elements in the first part are from Resources and Stores class from VDML elements found in DIH source 1. The elements in the second part are from M1 DIH cognitive level model storyline</p>	<p>-Inherent conclusion; a deliverable flow between: instructors, teachers, speakers, subject matter experts, matchmaking "officer"/broker, database, data lakes, coordinator, point of contact, liaison "officer", engineers, funds, financial resources, advisors, researchers, mentors, teachers, coaches, consultants</p> <p>-Inherent conclusion; a deliverable flow between: internal KT, Internal skills, Internal Human Capital, Internal/External Infrastructure, External Human Capital, External Skills, External KT, Technical Infrastructure</p>	<p>The elements in the first part are from Resources and Stores class from VDML elements found in DIH source 2. The elements in the second part are from M1 DIH cognitive level model storyline</p>
<b>Role association</b>	<b>Responsibility</b>	<p>Investor [117, p. 24]; so, for example a Responsibility that Investor takes on</p>	<p>-This element is from Role class in VDML found in DIH literature source 1</p> <p>-Investor is a role (not collaboration)</p>	<p>-As the source states: Knowledge/tech provider, Knowledge/tech recipient (recipient) [11, p. 28]. So, for example responsibility they have towards one another</p> <p>-Policy creator (enabler), Funding recipient (recipient); so, for example the responsibility of finding recipient ensured by the Policy</p>	<p>-These elements are from Role class in VDML found in DIH literature source 2</p> <p>-Investor is a role (not collaboration)</p>
<b>Value</b>	<b>Value</b>	Inherent conclusion: KT and TT		Inherent conclusion: KT and TT	

Table 34. below contains information gathered through conceptual mapping of VDML, e3value and DIH concepts found in literature based on [19], [117], and [11].

Table 34. Conceptual Mapping VDM L- e3value - DIH.

<b>VDML concept</b>	<b>e<sup>3</sup>value concept</b>	<b>DIH Lit Source 1 [117]</b>	<b>My Lit source 1 Comments</b>	<b>DIH Lit Source 2 [11]</b>	<b>My Lit source 2 Comments</b>
<b>Actor/ Collaboration</b>	<b>Actor</b>	<p>-For example, in a DIH or project: E-learning platform, Project Manager, Communication Officer, partners' points of contact, library (database)</p> <p>-As the source states: Micro- and small enterprises, Medium-sized enterprises, Mid-caps, Large companies (DIH customers) [117, p. 21].</p>	<p>-The first part is from Actor class VDML specification found in DIH.</p> <p>-The second part is from Collaboration class VDML specification found in DIH.</p>	<p>-For example, in a DIH or project: E-learning platform, Project Manager, Communication Officer, partners' points of contact, library (database)</p> <p>-As the source states: Incubators, research organizations, start-ups, SMEs, large companies, industry associations, governments [11, p. 15].</p>	<p>-The first part is from Actor class VDML specification found in DIH.</p> <p>-The second part is from Collaboration class VDML specification found in DIH.</p>
<b>Business Network</b>	<b>Composite Actor</b>	<p>-As the source states: Regional cluster organizations, Cluster organizations from other regions, Regional government (in case it is intergovernmental) , Chambers of commerce, Trade associations, Enterprise Europé Network (EEN) local (...), Innovation support organizations, Incubators, Vocational training organizations, Funding organizations, National government, Investors [117, p. 24].</p> <p>-As the source states (external human capital): Other DIHs outside the region, Universities within the region (not part of DIH) Universities outside the region, Business actors within the region (not part of DIH), Business actors outside the region, Business actors within the region (not part of DIH), Public actors outside the region,</p>	<p>-These elements are: VDML BusinessNetwork elements found in DIH, and they all can be considered a supporting Business Networks participating in parent business network, which is the definition of this e3value element [12, p. 106].</p>	<p>-As the source states: industry associations, governments (in case it is intergovernmental) , investors [11, p. 15].</p>	<p>-These elements are: VDML BusinessNetwork elements found in DIH, and they all can be considered a supporting Business Networks participating in parent business network, which is the definition of this e3value element [12, p. 106].</p>

		Public actors within the region (not part of DIH), Other DIHs within the region, Other DIHs outside the region [117, p. 28].			
<b>Business Network</b>	<b>Constellation</b>	<p>-As the source states: Regional cluster organizations, Cluster organizations from other regions, Regional government, Chambers of commerce, Trade associations, Enterprise Europé Network (EEN) local (...), Innovation support organizations, Incubators, Vocational training organizations, Funding organizations, National government, Investors [117, p. 24].</p> <p>-As the source states (external human capital): Other DIHs outside the region, Universities within the region (not part of DIH) Universities outside the region, Business actors within the region (not part of DIH), Business actors outside the region, Business actors within the region (not part of DIH), Public actors outside the region, Public actors within the region (not part of DIH), Other DIHs within the region, Other DIHs outside the region [117, p. 28].</p>	-These elements are: VDML BusinessNetwork elements found in DIH, and they all can be considered independent business entities exchanging value, which is the definition of this e3value element [12, p. 106].	-As the source states: industry associations, governments, investors [11, p. 15].	-These elements are: VDML BusinessNetwork elements found in DIH, and they all can be considered independent business entities exchanging value, which is the definition of this e3value element [12, p. 106].
<b>Deliverable Flow</b>	<b>Dependency Element</b>	<p>-educating [117, p. 5] - internationalization, [117, p. 18]</p> <p>-As the source states: training, skill developing, business advising, helping with business plans, supporting scale-up and internationalization, matching new firms with customers, testing and validating, attracting funding for</p>	These elements are from VDML Activity class found in this DIH literature source, where the only Role found is Investor [117, p. 24]. So, this element is about the flow of activities and Investor role [12, p. 107].	-As the source states: training, skill developing, supporting finding finance, networking, connecting [11, p. 16].	These elements are from VDML Activity class found in this DIH literature source, where the roles are: Knowledge/tech provider, Knowledge/tech recipient (recipient) [11, p. 28]. -Inherent conclusion: Policy creator (enabler), Funding recipient (recipient). So, this element is

		financing DIH activities [117, p. 18].			about the flow of activities and roles [12, p. 107].
<b>Community</b>	<b>Market Segment</b>	-As the source states: Micro- and small enterprises, Medium-sized enterprises, Mid-caps, large companies [117, p. 21].		-As the source states: Incubators, research organizations, start-ups, SMEs, large companies [11, p. 15].	Incubator is in VDML a member of both Community and Party classes.
<b>Scenario</b>	<b>Scenario</b>	nil		nil	
<b>Activity</b>	<b>Value Activity</b>	-educating [117, p. 18] -internationalization, [117, p. 18] -As the source states: training, skill developing, business advising, helping with business plans, supporting scale-up and internationalization, matching new firms with customers, testing and validating, attracting funding for financing DIH activities [117, p. 18].	Matching new firms with customer	-As the source states: training, skill developing, supporting finding finance, networking, connecting [11, p. 16].	Matching new firms with customers
<b>Business Network</b>	<b>Value Interface</b>	-As the source states: Regional cluster organizations, Cluster organizations from other regions, Regional government, Chambers of commerce, Trade associations, Enterprise Europé Network (EEN) local (...), Innovation support organizations, Incubators, Vocational training organizations, Funding organizations, National government, Investors [117, p. 24].  -As the source states (external human capital): Other DIHs outside the region, Universities within the region (not part of DIH) Universities outside the region, Business actors within the region (not part of DIH), Business actors outside the region,	-These elements are: VDML BusinessNetwork elements found in DIH, and they all determine the parties' value interface scope, which is the definition of this e3value element [12, p. 107].  -The "Value and Value Proposition" element of this DIH literature source is TT [12, p. 2].	"industry associations, governments, investors" [11, p. 15]	-These elements are: VDML BusinessNetwork elements found in DIH, and they all determine the parties' value interface scope, which is the definition of this e3value element [12, p. 107]. -The Value and Value Proposition elements of this DIH literature source are: coordination of actions, trust building, long-term commitment, enhanced skills development and SME participation, bridging the gap to traditionally non-digital value chains" [11, p. 25].  -diffusion of knowledge [11, p. 7].

		Business actors within the region (not part of DIH, Public actors outside the region, Public actors within the region (not part of DIH), Other DIHs within the region, Other DIHs outside the region [117, p. 28].			
<b>Business Item</b>	<b>Value Object</b>	- inherent conclusion: Solution, Policy	Elements from Value and Value Proposition VDML class	-inherent conclusion: Solution, Policy	Elements from Value and Value Proposition VDML class
<b>Value Proposition</b>	<b>Value Offering</b>	TT [117, p. 2]	Elements from “Value and Value Proposition” VDML class	-As the source states: coordination of actions, trust building, long-term commitment, enhanced skills development and SME participation, bridging the gap to traditionally non-digital value chains [11, p. 25].  -“diffusion of knowledge” [11, p. 7]	Elements from Value and Value Proposition VDML class
<b>Port</b>	<b>Value Port</b>	-Inherent conclusion: DIH office or Customer	DIH is point of departure and Customer is receipt of a value object/business item, based on to [12, p. 107]	-Inherent conclusion: DIH office or Customer	DIH is point of departure and Customer is receipt of a value object/business item, based on [12, p. 107]
<b>Unit of Production</b>	<b>Value Transaction</b>	-Inherent conclusion: regional clusters, Governments, Chambers of Commerce, Trade Associations, members of Enterprise Europé Network (EEN), Innovation support organizations, Incubators, vocational training organizations, funding organizations, Investors [117, p. 24].  -Inherent conclusion: other DIHs, Universities not in DIH, Business actors not in DIH, Public actors not in DIH [117, p. 28].	These are elements of VDML “Actor” class and also members of “Party” class, whilst member of “Value and Value Proposition” class element found is TT [12, p. 2]. So, it is a TT between these parties (according to [12, p. 107]).	-Inherent conclusion: Industries in particular industry associations, governments, investors [11, p. 15].	These are elements of VDML “Actor” class and also members of “Party” class, whilst member of “Value and Value Proposition” class element found are: coordination of actions, trust building, long-term commitment, enhanced skills development and SME participation, bridging the gap to traditionally non-digital value chains [11, p. 25].  -“diffusion of knowledge” [11, p. 7] is a flow of these value elements and these parties (according to [12, p. 107]).
<b>Deliverable Flow</b>	<b>Value Transfer</b>	Inherent conclusion: regional clusters, Governments, Chambers of Commerce, Trade	-These are elements of VDML “Actor” class, whilst member of “Value and Value Proposition” class	Inherent conclusion: Industries in particular industry associations, governments,	-These are elements of VDML “Actor” class, whilst member of “Value and Value



		<p>Associations, members of Enterprise Europé Network (EEN), Innovation support organizations, Incubators, vocational training organizations, funding organizations, Investors [117, p. 24].</p> <p>-Inherent conclusion: other DIHs, Universities not in DIH, Business actors not in DIH, Public actors not in DIH [117, p. 28].</p>	<p>element found is TT [117, p. 2]; so, it is a TT between these actors (according to [12, p. 107].</p>	<p>investors [11, p. 15].</p>	<p>Proposition” class element found are: coordination of actions, trust building, long-term commitment, enhanced skills development and SME participation, bridging the gap to traditionally non-digital value chains [12, p. 25].</p> <p>-“diffusion of knowledge” [12, p. 7] - it is a flow of these values between listed actors (according to [12, p. 107].</p>
--	--	---	---	-------------------------------	---

Table 35. below contains information gathered through conceptual mapping of VDML, Business Model Cube and DIH concepts found in literature based on [19], [117], and [11].

Table 35. Conceptual Mapping VDML - Business Model Cube - DIH.

<b>VDML Concept</b>	<b>Business Model Cube Concept</b>	<b>DIH Lit Source 1 [117]</b>	<b>My Lit source 1 Comments</b>	<b>DIH Lit Source 2 [11]</b>	<b>My Lit source 2 Comments</b>
<b>Capabilities</b>	<b>Competencies</b>	<p>Inherent conclusion: instructors, teachers, speakers, subject matter experts, matchmaking "officer"/broker, database, data lakes, coordinator, point of contact, liaison "officer", engineers, funds, financial resources, advisors, researchers, mentors, teachers, coaches, consultants</p>	<p>These are elements from VDML Resources and Stores class.</p>	<p>Inherent conclusion: instructors, teachers, speakers, subject matter experts, matchmaking "officer"/broker, database, data lakes, coordinator, point of contact, liaison "officer", engineers, funds, financial resources, advisors, researchers, mentors, teachers, coaches, consultants</p>	<p>These are elements from VDML Resources and Stores class.</p>
<b>Business network</b>	<b>Network</b>	<p>-As the source states: Regional cluster organizations, Cluster organizations from other regions, Regional government, Chambers of commerce, Trade associations, Enterprise Europé Network (EEN) local..., Innovation support organizations, Incubators, Vocational training organizations, Funding organizations,</p>	<p>These are elements from VDML "Business Network" class. According to specification, "Business Network" elements here are not restricted to business exchanges only [12, p. 109].</p>	<p>-As the source states: industry associations, governments, investors [11, p. 15].</p>	<p>These are elements from VDML "Business Network" class. According to specification, "Business Network" elements here are not restricted to business exchanges only [12, p. 109].</p>

		<p>National government, Investors [117, p. 24].</p> <p>-As the source states (external human capital):  Other DIHs outside the region,  Universities within the region (not part of DIH)  Universities outside the region,  Business actors within the region (not part of DIH),  Business actors outside the region,  Business actors within the region (not part of DIH),  Public actors outside the region,  Public actors within the region (not part of DIH),  Other DIHs within the region,  Other DIHs outside the region [117, p. 28].</p>			
<b>Deliverable flows</b>	<b>Relations</b>	<p>-educating [117, p. 5]  -internationalization [117, p. 18]</p> <p>-As the source states: training, skill developing, business advising, helping with business plans, supporting scale-up and internationalization, matching new firms with customers, testing and validating, attracting funding for financing DIH activities [117, p. 18].</p>	<p>-Matching new firms with customers</p> <p>-These are elements of VDML “Activity” class found in this DIH literature source. According to specification, this element connects internal activities and also capabilities with the external elements [12, p. 109].</p>	<p>-As the source states: training, skill developing, supporting finding finance, networking, connecting [11, p. 16].</p>	<p>-Matching new firms with customers</p> <p>These are elements of VDML “Activity” class found in this DIH literature source. According to specification, this element connects internal activities and also capabilities with the external elements [12, p. 109].</p>
<b>Party</b>	<b>User and customer</b>	<p>Inherent conclusion: regional clusters, Governments, Chambers of Commerce, Trade Associations, members of Enterprise Europé Network (EEN), Innovation support organizations, Incubators, vocational training organizations, funding organizations, Investors [117, p. 24].</p> <p>-Inherent conclusion: other DIHs, Universities not in DIH, Business actors not in DIH, Public</p>	<p>These are elements of VDML “Party” class found in this DIH source.</p>	<p>Inherent conclusion: Industries in particular industry associations, governments, investors [11, p. 15].</p>	<p>These are elements of VDML “Party” class found in this DIH source.</p>

		actors not in DIH [117, p. 28].			
<b>Value stream</b>	<b>Value chain</b>	-TT [117, p. 2]	This is from “Value and Value Proposition” class in VDML found in this DIH lit source	-As the source states: coordination of actions, trust building, long-term commitment, enhanced skills development and SME participation, bridging the gap to traditionally non-digital value chains [11, p. 25].  -“diffusion of knowledge” [11, p. 7]	This is from “Value and Value Proposition” class in VDML found in this DIH lit source
<b>Measure</b>	<b>Value formula (Profit formula)</b>	for example, size, strength, level of digitalization	This is from “MeasurableElement” class in VDML found in this DIH lit source	for example, size, strength, level of digitalization	This is from “MeasurableElement” class in VDML, found in this DIH lit source
<b>Value proposition</b>	<b>Value proposition</b>	TT [117, p. 2]	This is from “Value and Value Proposition” class in VDML found in this DIH lit source.	-As the source states: coordination of actions, trust building, long-term commitment, enhanced skills development and SME participation, bridging the gap to traditionally non-digital value chains [11, p. 25].  -“diffusion of knowledge” [11, p. 7]	This is from “Value and Value Proposition” class in VDML, found in this DIH lit source.

#### Appendix 4: List of Figures

Fig. 1. DIH-UML-MOF Methodology Explanation. ....	9
Fig. 2. VDML Profile Extended Metamodeling Methodology Explanation. ....	10
Fig. 3. DIH RMM Creation Methodology Explanation. ....	10

Fig. 4. DIH Mission. Source: Adjusted from EC publication [23], from the article written by Jurčić and Strahonja [40]. .....	32
Fig. 5. VDML viewpoints. Source: VDMbee [265]. .....	74
Fig. 6. M0 Cognitive Level DIH Representation. ....	77
Fig. 7. M1/1 Cognitive Level of DIH Model Representation as a UML Class Diagram. ....	82
Fig. 8. OMG's Metamodeling Conformance Metaclasses. ....	84
Fig. 9. M1/1 Cognitive Level of ValueandValueProposition Class in DIH Model Representation. ....	84
Fig. 10. ValueandValueProposition Metaclass in M1/2 Cognitive Level of DIH Model Representation. ....	85
Fig. 11. M1/1 Cognitive Level of Person and OrgUnit Classes in DIH Model Representation. ....	86
Fig. 12. OrgUnit and Person Metaclasses Associated to Actor Metaclass in M1/2 Cognitive Level of DIH Model Representation. ....	86
Fig. 13. M1/1 Cognitive Level of Activity Class in DIH Model Representation. ....	87
Fig. 14. Activity Metaclass Associated to Actor and VDML element Metaclasses in M1/2 Cognitive Level of DIH Model Representation. ....	87
Fig. 15. M1/1 Cognitive Level of BusinessItem and Collaboration Classes in DIH Model Representation. ....	88
Fig. 16. BusinessItem and CollaborationMetaclasses Associated to Collaboration Metaclasses in M1/2 Cognitive Level of DIH Model Representation. ....	88
Fig. 17. M1/1 Cognitive Level of Participant Class in DIH Model Representation. ....	89
Fig. 18. Participant, Role and Activity Metaclasses in M1/2 Cognitive Level of DIH Model Representation. ....	90
Fig. 19. Role, RoleDeifnition, RoleCategory and RoleLibrary Metaclasses in M1/2 Cognitive Level of DIH Model Representation. ....	90
Fig. 20. M1/1 Cognitive Level of Capability and CapabilityLibrary Classes in DIH Model Representation. ....	91
Fig. 21. Capability and CapabilityLibrary Metalasses in M1/2 Cognitive Level of DIH Model Representation. ....	92
Fig. 22. M1/1 Cognitive Level of Assignment Class in DIH Model Representation. ....	92

Fig. 23. Assignment Metalasses in M1/2 Cognitive Level of DIH Model Representation. ...	93
Fig. 24. M1/1 Cognitive Level of BusinessNetwork and Party Classes in DIH Model Representation.....	93
Fig. 25. BusinessNetwork and Party Metalasses in M1/2 Cognitive Level of DIH Model Representation.....	94
Fig. 26. M 1/1 Cognitive Level of Community and Member Classes in DIH Model Representation.....	95
Fig. 27. Community and Member Metalasses in M1/2 Cognitive Level of DIH Model Representation.....	95
Fig. 28. M 1/1 Cognitive Level of Position Class in DIH Model Representation. ....	96
Fig. 29. Position Metaclass in M1/2 Cognitive Level of DIH Model Representation. ....	96
Fig. 30. MeasurableElement, MeasuredCharacteristic, Annotation and Attributes Metaclasses in M1/2 Cognitive Level of DIH Model Representation. ....	97
Fig. 31. M1/2 Cognitive Level of DIH Model Representation as UML Class Diagram. ....	98
Fig. 32. Osterwalder's BMC Model Enriched with Some Additional Exemplary Members of the Given Classes. ....	104
Fig. 33. BMC Metamodel Proposal. Source: [316, p. 3]. ....	105
Fig. 34. Value Network Model for Interoperable IoT Ecosystems. Source: [317, p. 7]. ....	107
Fig. 35. DIH VNA Graph Example. ....	108
Fig. 36. VNA Model. ....	110
Fig. 37. TOGAF Scope. Source: The Open Group [17]. ....	111
Fig. 38. TOGAF Core Content Metamodel. Source: The Open Group [320, p. 9]. ....	113
Fig. 39. TOGAF Full Content Metamodel. Source: The Open Group [320, p. 10]. ....	117
Fig. 40. TOGAF Value Stream Modeling Relationships. Source: The Open Group [264, p. 3]. ....	118
Fig. 41. DIH Value Stream Example #1 Stages.....	121
Fig. 42. DIH Cross-Mapping Value Stream Stages to Business Capabilities Example #1. .	122
Fig. 43. DIH Value Stream Example #1 Model.....	123
Fig. 44. DIH Value Stream Example #2 Stages.....	125
Fig. 45. DIH Cross-Mapping Value Stream Stages to Business Capabilities Example #2. .	126
Fig. 46. DIH Value Stream Example #2 Model.....	127

Fig. 47. DIH Value Stream Example #3 Stages.....	129
Fig. 48. DIH Cross-Mapping Value Stream Stages to Business Capabilities Example #3. .	129
Fig. 49. DIH Value Stream Example #3 Model.....	130
Fig. 50. DIH Value Stream Example #4 Stages.....	132
Fig. 51. DIH Cross-Mapping Value Stream Stages to Business Capabilities Example #4. .	133
Fig. 52. DIH Value Stream Example #4 Model.....	134
Fig. 53. DIH Value Stream Example #5 Stages.....	136
Fig. 54. DIH Cross-Mapping Value Stream Stages to Business Capabilities Example #5. .	136
Fig. 55. DIH Value Stream Example #5. ....	137
Fig. 56. DIH Value Stream Metamodel. ....	138
Fig. 57. REA Model. ....	141
Fig. 58. Metamodel of REA Model. Source: [325, p. 222].....	142
Fig. 59. e3value Model.....	146
Fig. 60. e3value Metamodel. Source: [330, p. 67].....	147
Fig. 61. Lindgren's BMC. Source: [331].....	149
Fig. 62. Lindgren's BMC Model. ....	152
Fig. 63. DIH Catalogue. Source: <a href="https://s3platform.jrc.ec.europa.eu/digital-innovation-hubs-tool">https://s3platform.jrc.ec.europa.eu/digital-innovation-hubs-tool</a> [118].....	177
Fig. 64. DIH Contact List. Source: <a href="https://s3platform.jrc.ec.europa.eu/digital-innovation-hubs-tool">https://s3platform.jrc.ec.europa.eu/digital-innovation-hubs-tool</a> [118]. ....	178
Fig. 65. DIH Profile Page. Source: <a href="https://s3platform.jrc.ec.europa.eu/digital-innovation-hubs-tool/-/dih/1152/view?_eu_europa_ec_jrc_dih_web_DihWebPortlet_backUrl=%2Fdigital-innovation-hubs-tool">https://s3platform.jrc.ec.europa.eu/digital-innovation-hubs-tool/-/dih/1152/view?_eu_europa_ec_jrc_dih_web_DihWebPortlet_backUrl=%2Fdigital-innovation-hubs-tool</a> [334].....	179
Fig. 66. DIH RMM Concepts Covering DIH Catalogue Elements (Attributes). Source: Authors own conclusion and [334]. ....	180
Fig. 67. Clients/customers of a DIH Listed on DIH Profile Page. Source: [334]. ....	181
Fig. 68. Business Networks (Collaborations) of a DIH listed on DIH Profile Page. Source: [334]. ....	182
Fig. 69. EIT HUB ISRAEL Statement of Value and Value Proposition. Source: <a href="https://go-eit.eu/eit-israel-hub/">https://go-eit.eu/eit-israel-hub/</a> [337].....	183

Fig. 70. EIT HUB ISRAEL Another Statement of Value and Value Proposition. Source: <a href="https://go-eit.eu/eit-israel-hub/our-community/#our-community">https://go-eit.eu/eit-israel-hub/our-community/#our-community</a> [338].	183
Fig. 71. EIT HUB Israel Activities. Source: <a href="https://go-eit.eu/eit-israel-hub/">https://go-eit.eu/eit-israel-hub/</a> [337].	184
Fig. 72. EIT BHUB ISRAEL Communities of Interest. Source: <a href="https://go-eit.eu/eit-israel-hub/">https://go-eit.eu/eit-israel-hub/</a> [337].	185
Fig. 73. EIT HUB ISRAEL Events. Source: <a href="https://go-eit.eu/eit-israel-hub/our-programmes/#events">https://go-eit.eu/eit-israel-hub/our-programmes/#events</a> [339].	185
Fig. 74. EIT HUB SYLICON VALLEY Collaboration. Source: <a href="https://go-eit.eu/eit-silicon-valley-hub/our-programmes/#events">https://go-eit.eu/eit-silicon-valley-hub/our-programmes/#events</a> [340].	186
Fig. 75. EIT HUB SYLICON VALLEY Communities of Interest. Source: <a href="https://go-eit.eu/eit-silicon-valley-hub/">https://go-eit.eu/eit-silicon-valley-hub/</a> [341].	187
Fig. 76. EIT HUBSYLICON VALLEY Activities. Source: <a href="https://go-eit.eu/eit-silicon-valley-hub/our-programmes/#programmes">https://go-eit.eu/eit-silicon-valley-hub/our-programmes/#programmes</a>	187
Fig. 77. EIT HUB SYLICON VALLEY Events. Source: <a href="https://go-eit.eu/eit-silicon-valley-hub/our-programmes/#events">https://go-eit.eu/eit-silicon-valley-hub/our-programmes/#events</a> [342].	188
Fig. 78. EIT HUB SYLICON VALLEY Value and Value Proposition. Source: <a href="https://go-eit.eu/eit-silicon-valley-hub/who-we-are/">https://go-eit.eu/eit-silicon-valley-hub/who-we-are/</a> [343].	189
Fig. 79. EIT HUB SYLICON VALLEY also Value and Value Proposition. Source: <a href="https://go-eit.eu/eit-silicon-valley-hub/who-we-are/">https://go-eit.eu/eit-silicon-valley-hub/who-we-are/</a> [343].	189
Fig. 80. Variant 1 of M0 DIH VDML.	212
Fig. 81. Variant 2 of M0 DIH VDML.	213
Fig. 82. Variant 3 of M0 DIH VDML.	214
Fig. 83. Variant 4 of M0 DIH VDML.	215
Fig. 84. Variant 1 of M1/1 DIH VDML.	216
Fig. 85. Variant 2 of M1/1 DIH VDML.	217
Fig. 86. Variant 3 of M1/1 DIH VDML (internal ecosystem).	218
Fig. 87. Variant 3 of M1/1 DIH VDML (external ecosystem).	219
Fig. 88. Variant 4 of M1/1 DIH VDML (internal ecosystem).	220
Fig. 89. Variant 4 of M1/1 DIH VDML (external ecosystem).	221
Fig. 90. VDML Profile Extended Metamodeling Methodology Explanation (Revisited).	316
Fig. 91. DIH RMM Creation Methodology Explanation (Revisited).	316

Fig. 92. M0 Cognitive Level DIH Representation (Revisited). .....	318
Fig. 93. M1/1 Cognitive Level of DIH Model Representation as a UML Class Diagram (Revisited). .....	322

## Appendix 5: Invitation Letter and Presentation for the Practical Part of the Research

### **Invitation letter:**

Dear Sir/Ma'am,

As a part of my doctoral thesis research, I have prepared questions for an in-depth interview, which should last no longer than one hour. This part of the research is intended for DIH experts,



primarily in order to verify weather generic DIH model (DIH referent meta-metamodel, DIH RMM) for which I proposed a design is holistic. The main problem of my research is the design of DIH RMM, which will serve as a benchmark for other DIHs, DIH comparison, improvement of DIH interoperability and structuring of DIH catalogue. DIHs are not sufficiently present in scientific literature, so my intent is to at least partially fill that gap.

Please find attached a short presentation with all the relevant information. I hope that you will be so kind and take some time away from your busy schedule in order to participate in the interview, and I will of course adjust to your schedule.

Thank you so much, Marina Jurcic, mr.sc. MBA

**Short presentation attached to invitation letter:**

# Digital Innovation Hub as Intermediary and Value Delivery System



Marina Jurčić, mr. sc. MBA

## Motivation

- potential of DIHs in the area of digitalization, knowledge transfer (KT), and Value Delivery, while having an immense impact on European economy
- EU Member States aspire to stay competitive on global market, and in order to achieve that, they are also trying to raise their level of digitalization, for which effective KT is crucial
- EU is the contributor of one fifth of the highly cited scientific publications in the world, yet it is falling behind US and Japan when it comes to innovation output

## Main Problem and Research Field

### Main Problem:

design of generic DIH model (DIH RMM), which will serve as:

- benchmark for other DIHs.
- DIH comparison.
- improvement of DIH interoperability and
- structuring of DIH catalogue

### Research Field:

- determining elements of DIHs as intermediaries in processes of KT
- methodology of describing, establishing and viewing DIHs as value delivery systems (VDS) through VDML metamodeling.

## KT Intermediaries

- serve as catalysts, and which require better insight.
- match industry needs through KT, provide a link to financing sources, contribute to development of trust and support partner identification.
- scientific literature review has identified about fifty problems related to intermediaries
- amongst the intermediaries are also Digital Innovation HUBs (DIHs)
- DIHs are not sufficiently present in scientific literature, so my intent is to at least partially fill that gap

## Main Objectives of the Thesis

- Identification of factors which influence problems of intermediaries in Value Delivery (VD) from research community to industry and vice versa, and how DIH fits into that;
- Identification of DIH similarities and specifics in comparison to other intermediaries;
- Identification of DIH solutions for architecture, platforms, interoperability interface and matchmaking;
- Design of DIH VDML metamodel proposal, as a model of DIH value creation;
- Establishing the degree of conformance and incompatibilities of DIH with VDML metamodel; and
- The design of DIH Referent Meta-Metamodel (DIH RMM) proposal.

## Main Hypotheses

**H1:** In accordance with relevant theories of value delivery, Digital Innovation Hub is a Value Delivery System.

**H2:** Digital Innovation Hub Referent Meta-Metamodel is an adequate instrument for determining conformance of referent architectures which contain concepts of Value Delivery.

## Methods

- DIH in its essence is a value delivery system (VDS), value being knowledge and skills transferred to its customers seeking help with business digitalization.
- Value Delivery Modeling Language (VDML) and metamodeling could be used in order to create DIH referent metamodel (DIH RMM) design.
- DIH as VDS could be mapped onto a VDML metamodel, which would contain all the meta-information about a DIH model and their mapping, in order to explore its suitability for DIH RMM.
- that could be established by proving the conformity of DIH RMM with value delivery (VD) metamodel (part of the VDML specification).
- DIH RMM would be a concept, which would later down the line be able to generate new DIH models.
- DIH characteristics which make it suitable for VD models are its structures and relationships that can be mapped onto VDML metamodel subset; classes defined by Object Management Group.

## Methods

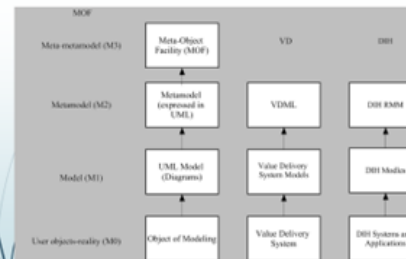

Here you can see the complete methodology, where **DIH RMM** is the final product.

## Contribution:

- practical use of the proposed VDML DIH metamodel as a conceptual framework for DIH modeling, and DIH RMM, which as a part of a wider framework could be used for DIH benchmarking, comparison of DIHs, as a reference point providing guidance for what a DIH should be comprised of, design of information systems with compatible semantics, and also for structuring of DIH catalogue

## Appendix 6: List of Literature Used for Preliminary DIH VDML (Meta)Model Representation (and Conceptual Mapping)

1. J. Miörner, G. Rissola, J. Sörvik and J. Wernberg, "Putting Digital Innovation Hubs into Regional Context," Publications Office of the European Union, Luxemburg, 2019.
2. C. E. Lantz and K. Wu, "Building and managing an innovation hub: A case study of the challenges and opportunities faced by," 2017. [Online]. Available: <https://www.semanticscholar.org/paper/Building-and-managing-an-innovation-hub-%3A-A-case-of-Wu-Lantz/af0732e82d1f2c67b676fc054c88a009f0790dea>.
3. R. Virkkunen, K. Still and L. Rosso, "Digital Innovation Hubs in Finland," 2019. [Online]. Available: [https://julkaisut.valtioneuvosto.fi/bitstream/handle/10024/161585/TEM\\_2019\\_27\\_Digital\\_Innovation\\_Hubs\\_in\\_Finland.pdf?sequence=1](https://julkaisut.valtioneuvosto.fi/bitstream/handle/10024/161585/TEM_2019_27_Digital_Innovation_Hubs_in_Finland.pdf?sequence=1). [Accessed 15 1 2020].
4. J. Miörner, A. Kalpaka, J. Sorvik and J. Wernberg, "Exploring heterogeneous Digital Innovation Hubs in their context," Publications Office of the European Union, 2019, Luxemburg, 2019.
5. E. Commission, "DIHELP- DIH enhanced Learning Programme," 1 2019. [Online]. Available: [http://dihelp.eu/wp-content/uploads/2019/01/DIHELP\\_Guide-for-Applicants\\_updated.pdf](http://dihelp.eu/wp-content/uploads/2019/01/DIHELP_Guide-for-Applicants_updated.pdf). [Accessed 1 2 2020].
6. E. Commission, "EU Budget for the Future," 2018. [Online]. Available: [file:///G:/FOI/09%20Pregled%20literature%20za%20disertaciju/digi/KI0118587ENN.en%20\(2\).pdf](file:///G:/FOI/09%20Pregled%20literature%20za%20disertaciju/digi/KI0118587ENN.en%20(2).pdf). [Accessed 1 2 2020].
7. E. Commission, "Roundtable on Digitising European Industry, WG1, Digital Innovation Hubs: Mainstreaming Digital Innovation Across All Sectors," Commission, European, Bruxelles, 2017.
8. G. Rissola and J. Sörvik, "Digital Innovation Hubs in Smart Specialisation Strategies," 24 1 2018. [Online]. Available: <https://digital-strategy.ec.europa.eu/en/library/digital-innovation-hubs-smart-specialisation-strategies>. [Accessed 11 6 2019].

## Appendix 7: Instruments for Semi-Structured In-Depth Interviews with DIH Experts

- **In the first part of the interviewing process, five interviews were conducted with DIH experts from EC and national authorities:**

### **Intro:**

Interview will be audio recorded and notes will be taken during interview.

The main goals of the interview are:

- (1) Confirmation from practice regarding the suitability of the selected DIH cases from DIH expert literature, which were chosen for DIH RMM design and in-depth interview research,
- (2) Identification of DIH RMM artifacts/elements which are missing or should be removed in order to determine the degree of compliance and incompatibilities of DIH with VDML metamodel,
- (3) Confirmation or adjustment and redefinition of DIH RMM.

Purpose of the interview is VDML DIH metamodel verification.

Data collected will be used in scientific purposes.

Identification of interviewees will not be possible- special attention will be given to anonymity of the interviewees.

All will be conducted with signed informed consent.

- a) **The interview will start with explanation of the methodology illustrations (ask for opinion) on: Fig. 90., Fig 91. and Fig 92. – all based on [40].**

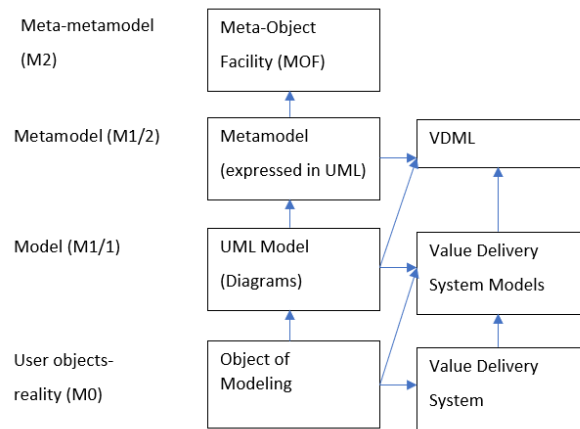

Fig. 90. VDM Profile Extended Metamodeling Methodology Explanation (Revisited).

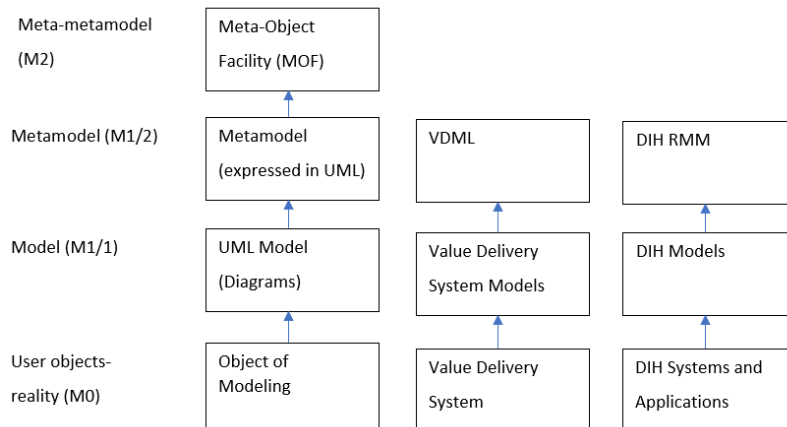

Fig. 91. DIH RMM Creation Methodology Explanation (Revisited).

b) **The interview will continue with explanation of OMG’s VDM Collaboration Modeling Conformance elements [35]** (concept definitions, to what are connected, do they recognize these elements in reality-what would they be in DIH- give examples (other concepts), in which documents is it described (policies, strategies); semantics descriptions, architecture descriptions):

1. ValueDeliveryModel
2. VdmlElement
3. MeasurableElement

4. Attributes
5. Annotation
6. MeasuredCharacteristic
7. PortContainer
8. Collaboration
9. Role
10. RoleDefinition
11. RoleLibrary
12. RoleCategory
13. Participant
14. Actor
15. Person
16. Assignment
17. OrgUnit
18. Position
19. Community
20. Member
21. BusinessNetwork
22. Party

c) **List of literature used for preliminary DIH VDML (meta)model representation (and conceptual mapping) in Appendix 6 (ask for opinion):**

d) **My DIH story:**

DIH M0 cognitive level visualization of basic elements in words would be the following:

1. DIH's work, a work of Value Delivery System, is defined by different Policies.
2. DIH is an aggregation of Internal and External Infrastructure, and a part of it is also Technical Infrastructure.
3. DIH is also an aggregation of Human Capital, which is comprised of:
  - a) Internal Human Capital, which encompass the following-
    - Internal Skills (a part of which is also KT),
    - University/Research Establishments and Business Actors (in DIH Consortium),
    - Public Actors in DIH Consortium;
  - b) External Human Capital, which encompass the following-

- External Skills (a part of which is also KT),
- Other DIHs out of Region,
- University and Research Establishments in Region,
- University and Research Establishments out of Region,
- Business Actors in Region (Not Part of DIH),
- Business Actors out of Region,
- Public Actors in Region (Not Part of DIH),
- Public Actors out of Region,
- Other DIHs in Region.

4. Client/customer comes to DIH to ask for a service.

a) M0 conceptual level illustration of DIH (real life):

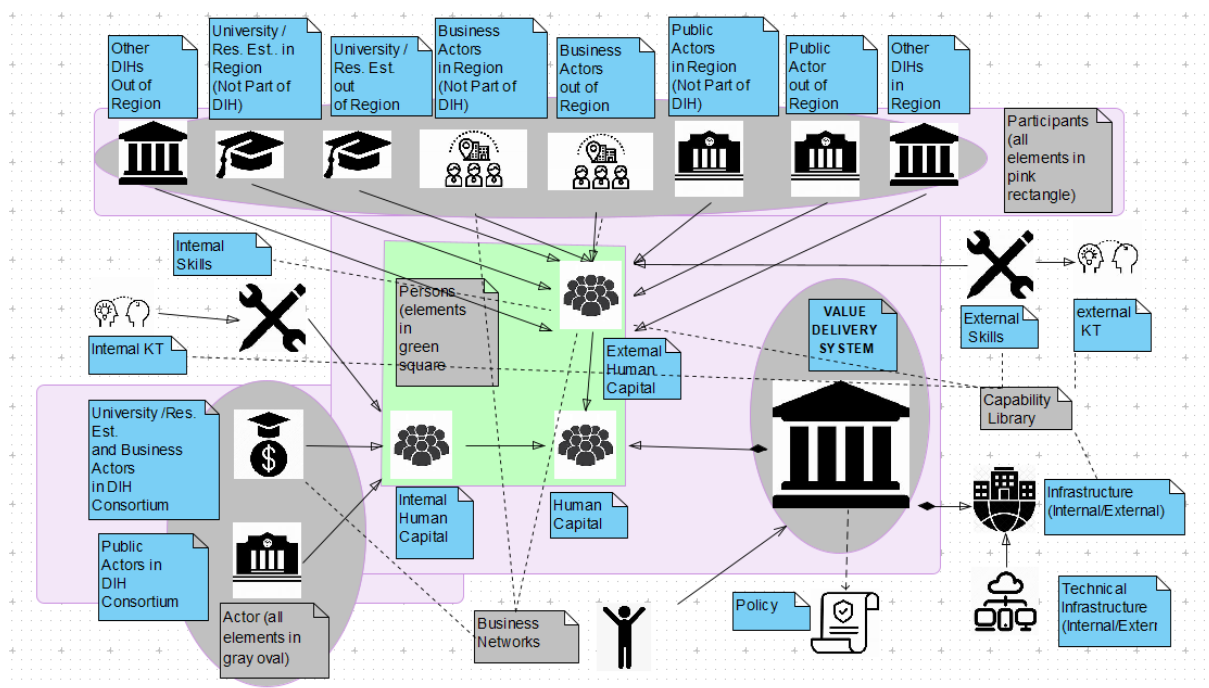

Fig. 92. M0 Cognitive Level DIH Representation (Revisited).

Can you recognize real system elements:

- Looking at this graphic illustration of M0 DIH conceptual level do you think all the relevant components of *DIH office* have been encompassed? Are there contributions which would require extensions?
- Does the graphic need further clarification?

- Is there anything else that should be added?
- Do you see anything that should be taken off the graphic?
- Do you see anything drawn on the wrong place or in a wrong way?
- Are DIHs really non-profit or not; how are they financed?
- Does DIH evolve in time and space.

b) DIH M1/1 conceptual level; it is UML class diagram (taking into account VDML specification with DIH elements added):

M1/1 Cognitive Level of DIH Model representation, in accordance with VDML specification and DIH literature, the storyline would then be the following:

1. DIH functions in the way that clients/customers get preliminary information about DIH. That can happen through social media channels, DIH web page or through newsletters.
2. DIHs web page contains all the relevant information about DIH; an entire service portfolio description (matchmaking, KT, TT, training, mentoring, business plan proposal, advise proposals etc.); it is DIH's Value and Value Proposition.
3. DIHs service is primarily focused on SMEs, but Client/customer can be a private Person (human Actor) or legal entity (OrgUnit) which after visiting DIHs web page decides to visit DIH in order to pursue one of the options from DIH portfolio.
4. Persons class will be composed of the following elements: Human Capital- Internal Human Capital and External Human Capital; and a Client/customer.
5. Client/customer then interacts with DIH's staff (Internal Human Capital); the interaction is initially in the form of a meeting (Activity), a conversation regarding the client's/customer's issues where DIH's staff is trying to offer the best possible solution within their premises.
6. In case that DIH's office cannot help the client/customer with their own Internal Skills and Internal Infrastructure, they engage other entities out of DIH office which Collaborate with DIH (External Human Capital), in order to rely on the(ir) External Skills and External Infrastructure.
7. According to OMG's VDML specification, multiple Participants (human/non-human Actors or another *Collaboration*) take part in collaboration.



8. Through this collaboration of different participants available to DIH, the best possible solution (BusinessItem) is found or custom made for the Client/customer.
9. Participant class will be composed of the following elements (drawn in pink rectangle): DIH; Human Capital (Internal Human Capital; External Human Capital); University/Research Establishments and Business Actors in DIH Consortium; Public Actors in DIH Consortium; Other DIHs out of Region; University and Research Establishments in Region; University and Research. Establishments out of Region; Business Actors in Region (Not Part of DIH); Business Actors out of Region; Public Actors in Region (Not Part of DIH); Public Actors out of Region; and Other DIHs in Region - will be a part of Participants class;
10. Based on OMG's specification, Participants take part in collaboration, through their own one or more assigned *Roles*. So, an entity which comes to DIH asking for help, as a Customer (with a Role of Customer), is also a Participant directly involved in Collaboration.
11. Based on OMG's specification, every participant can be a part of more than one collaboration.
12. Actor class will be composed of the following elements: DIH; Other DIHs out of Region; University/Research Establishments in Region; University/Research Establishments out of Region; Business Actors in Region (Not Part of DIH); Business Actors out of Region; Public Actor in Region (Not Part of DIH); Public Actor out of Region; and Other DIHs in Region; University/Research Establishments and Business Actors (in DIH Consortium); Public Actors in DIH Consortium; Business Actors out of Region, Public Actors in Region not Part of DIH; Policies and also Client/customer.
13. According to OMG's specification, Collaboration is composed of one or more *Activities*, each performed by one Role in Collaboration. In DIH collaborations, which are often comprehensive activities, usually involve a sequence of activities before the final solution is found/created.
14. According to OMG's specification, one Role may perform more than one Activity and if they require different Capabilities, Participant should be able to cover them all. When DIHs are small, often each DIH's Participant is expected to have many

Capabilities; for those Capabilities, DIH first looks for in Internal Skills and Internal Infrastructure, and if they cannot be found there, then in External Skills and External Infrastructure.

15. All the capabilities that DIH has to offer are in CapabilityLibrary class, so it will be composed of the following elements: internal KT, external KT; Internal Skills; External Skills, Internal/External Infrastructure; and Technical Infrastructure.
16. According to OMG's specification, Participant is involved in Activity through *Assignment*, which specifies how a Role in a Collaboration can be fulfilled. So, a customer's assignment would be to obtain the solution.
17. According to OMG's specification, BusinessNetwork is Collaboration of *Parties*, which identify roles in business networks.
18. BusinessNetworks class will be composed of the following elements: Business Actors in Region (Not Part of DIH); Business Actors out of Region; and University/Research Establishments and Business Actors (in DIH Consortium).
19. Parties in this case where DIH cannot find a solution for the Customer within its own premises would for example be infrastructure provider, funding provides, knowledge provider, legal advice provider etc.
20. According to OMG's specification, Community is a collaboration of Participants, where a role is identified by *Member*.
21. Different communities may also be formed from members of DIH's Internal Human Capital or External Human Capital, in order to reach a specific solution through collaboration.
22. According to OMG's specification, Role in OrgUnit is identified by Position.

c) M1/1 Cognitive Level of DIH Model representation

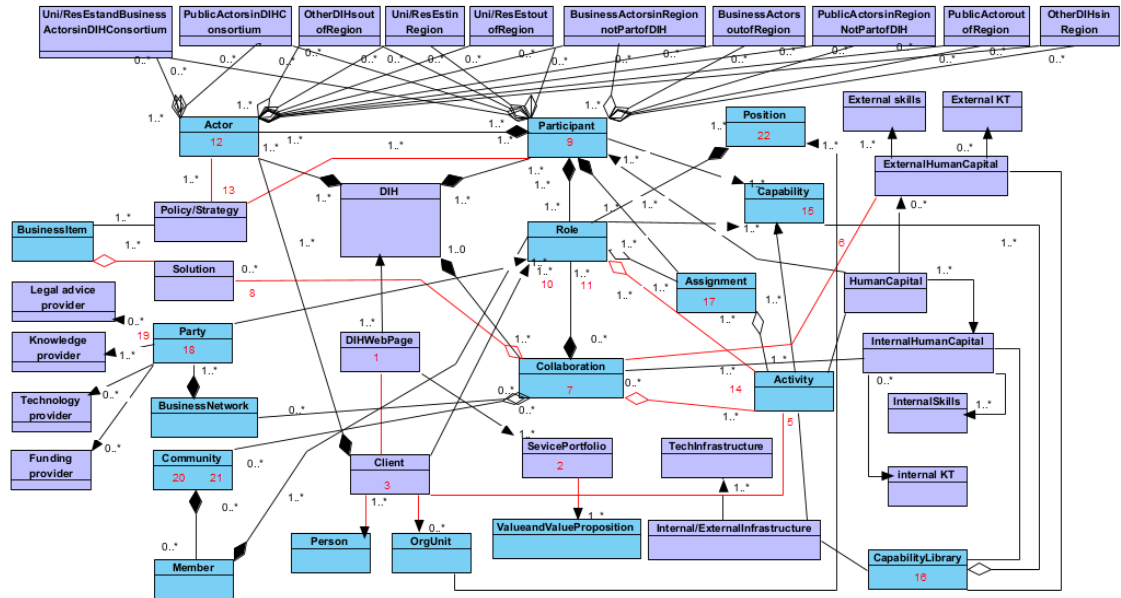

Fig. 93. M1/1 Cognitive Level of DIH Model Representation as a UML Class Diagram (Revisited).

Can you map between M0 and M1:

- Can you recognize all the elements from M0 on M1 illustration?
- Do you feel like all the DIH elements from M0 are adequately represented in M1?
- Do you think the model lacks elements?
- Do you think any of the models have unnecessary elements?

d) **What is your opinion on referent architectures used for additional DIH views (Osterwalder’s Business Model Canvas, VNA, TOGAF, REA, e3value and Lindgren’s Business Model Cube)?**

e) **What is your opinion regarding the questionnaire for DIH members.**

- **In the second phase, interviews were conducted with different DIH experts. Instrument for semi-structured in-depth interview with different DIH experts is the following:**

Interview will be audio recorded and notes will be taken during interview.

The main goal of the interview is (3) Confirmation or adjustment and redefinition of DIH RMM. DIH RMM will then afterwards be validated by a focus group.

Purpose of the interview is VDML DIH metamodel verification

Data collected will be used in scientific purposes

Identification of interviewees will not be possible- special attention will be given to anonymity of the interviewees

All will be conducted with signed informed consent.

- a) The interview will start with explanation of the methodology
- b) The interview will continue with explanation of OMG's VDML Collaboration Modeling Conformance elements [35] (concept definitions, to what are connected, do they recognize these elements in reality-what would they be in DIH- give examples (other concepts), in which documents is it described (policies, strategies); semantics descriptions, architecture descriptions):
  1. ValueDeliveryModel
  2. VdmlElement
  3. MeasurableElement
  4. Attributes
  5. Annotation
  6. MeasuredCharacteristic
  7. PortContainer
  8. Collaboration
  9. Role
  10. RoleDefinition
  11. RoleLibrary
  12. RoleCategory
  13. Participant
  14. Actor
  15. Person
  16. Assignment
  17. OrgUnit
  18. Position
  19. Community
  20. Member
  21. BusinessNetwork
  22. Party
- c) What are the resources of a DIH
- d) Who are the clients/customers of your DIH?
- e) How do you think quantum computing/quantum communication will impact DIHs?
- f) Is there anything regarding DIHs that I forgot to ask and you felt it's important to add?

## Appendix 8: Notes from the Interviewing Process

### Notes taken during the first part of interviewing process:

1.

*-If you were to follow the efficiency of DIHs, which indicators would you be looking at?*

*European DIHs will be very different across Europe; in most industrialized regions, they will do high tech stuff, in other regions very basic stuff, so the value DIHs bring to SMEs is very different (in some cases experiments in high tech, giving the possibility of using experimental facility; in other cases, training or daily introduction of basic digital technology).*

*How to evaluate the performance of the network? EDIHs will have Digital Transformation Accelerator (<https://digital-skills-jobs.europa.eu/en/opportunities/funding/dg-cnect-digital-transformation-accelerator-network-edih>, <https://digital-strategy.ec.europa.eu/en/funding/digital-transformation-accelerator-network-edih-cnect2021op0004>), central office, starting September 2022 (procurement contracts have been selected). These guys will have to support the network: organize events, helping HUBs find each other...performance of DIHs will be based on several things written in the work programme (Calling notice: [https://ec.europa.eu/info/funding-tenders/opportunities/docs/2021-2027/digital/wp-call/2021/call-fiche\\_digital-2021-edih-01\\_en.pdf](https://ec.europa.eu/info/funding-tenders/opportunities/docs/2021-2027/digital/wp-call/2021/call-fiche_digital-2021-edih-01_en.pdf) and the work programme of DIHs: [https://ec.europa.eu/newsroom/repository/document/2021-45/C\\_2021\\_7911\\_1\\_EN\\_annexe\\_acte\\_autonome\\_cp\\_part1\\_v2\\_d4ygL3fB7OJrEhLGIXBaC5w0X0\\_80907.pdf](https://ec.europa.eu/newsroom/repository/document/2021-45/C_2021_7911_1_EN_annexe_acte_autonome_cp_part1_v2_d4ygL3fB7OJrEhLGIXBaC5w0X0_80907.pdf)). In one of them (probably work programme) is explained what are the targets of DIHs (indicators which we will evaluate) like number of companies they helped, number of courses they have done, evolution of digital maturity of companies. JRF (Joint Research Center of EC) developed methodology to evaluate digital maturity the adopted it to DIHs (made questionnaire for it). Digital Transformation Accelerator will implement this (make online tool to help DIHs fill this data)- this will be main feedback for evaluation how the DIH network is performing because they want to know how many companies they*

*contacted, how many companies were helped (from zero to initial use of digital tech or advanced to high tech). In 3 years, there will be another call for completing the network, like the hubs which will not receive the funding in September (2025-2026 another call for the next four years for the programme). European budget works in 7-year chunks, so Digital Europe Programme started in 2021, then pandemic. But in practice is starting in 2022 so it will end in 2027/2028- it's a very long-term strategy, so this kind of feedback is very important in order to know how to refocus.*

*Digital Transformation Accelerator is mentioned in the work programme and it is a procurement contract (there were a couple of good proposals)- they selected one. The coordinator is Spanish company CARSA (<https://carsa.es/specialised-business-support-services-for-preparing-european-digital-innovation-hubs-edihs/?lang=en> )- is a consortium working with in ScineceTech (?) consulting company from Germany and InterSoft (software part) and the one dealing with courses- contracts will be signed at the beginning of September (will start end of September beginning Oct). Not sure if there will be physical office- maybe office in Bruxelles for meetings, web portal will be the most visible site/instrument for online courses, organizing online events/meetings, sharing data- they specified many functionalities for them to implement, organizing one big physical event per year, then several more for networking i.e. DIHs working on cyber or digital security- events for them to know each other and be able to cooperate.*

*-DIH Catalogue online- not clearly defined what all elements a DIH is supposed to be composed of, not all are real DIHs...?*

*They started working on DIHs in 2016, JFC developed catalogue, and any organization can say they are DIHs and provide some info where they get money from, in which area they are active etc. There is a lot of garbage, and some are candidates for EDIHs, not all were selected. Digital Transformation Accelerator has to create a catalogue- those who were selected should get the funding from Digital Europe Programme. 136 DIHs have been selected for EDIHs, will start in September until Jan 2023 (at the beginning of 2023 all of them will be operational. In the meanwhile, there will be a second call, because there were some holes in the network for some regions- another 10 DIHs will probably be selected for EDIHs, so in total cca 150*

*EDIHs, all will be in the catalogue (all the public info). The JFC catalogue is just to see what has been done in the past (it is not up to date, will be taken offline asap).*

*<https://digital-strategy.ec.europa.eu/en/news/pre-selection-process-european-digital-innovation-hubs-list-of-POCs>: HR- mirela.cokesic@mingor.hr, Marina.skelin@mingor.hr*

*-What exactly does non-profit mean?*

*Cannot profit from the work of HUB (50%EU, 50% member states- public money, so should not use it to make money out of it), they will just get their costs covered. Same with Horizon and other programs of EU. Subcontracting cannot be the core activity of any funded project.*

*-What would be activities DIHs do?*

*Test before invest is the most important (create prototype, laboratory for testing it). The company gets know-how and understanding, they have to invest their own money if they want to use it in business. Training (not only helping SMEs to use basic IT, but also to know what is supported by Digital Europe Programme). Digital Europe is the first programme for the broad deployment of digital technology and it is not about doing the state of the art but making available tech enabled for SMEs; DIH help SMEs what in Digital Europe Program is available in this area (AI, cyber security, to set firewall correctly...).*

*DIH Adria has interesting proposals on maritime technology which needs to be looked at- not all options have been considered yet.*

*-How could quantum computing affect DIHs?*

*Very little, no applications for it right now, maybe will be important in future. EDIHs have a lifespan of 3 yrs. Quantum communications (creating communications where you know if someone in it read the message, on short distances, we can be sure that no one in the middle is participating- so this can be a game changer, but they plan to develop key exchange algorithms for quantum communication).*

*-What collaboration do DIHs use in their work?*

*DIHs should collaborate with all the actors which do something similar (similar tech/market segments). European enterprise Network initiative works with industrialization of companies-*

*idea is they should have similar experiences. Some of the collaborations will be stable- for manufacturing, some HUBs do formal network (events for info exchange) like subnetwork of the network (people know each other). Other collaborations will be more time- bound (exchange of info, and then go back to their own activities). So static/stable (several years), and variable collaborations (one-to-one, one-time basis or for maybe 2 months).*

*-What business networks would HUBs be involved in?*

*Collaboration with research institutions, with financial institutions (helping SMEs to access investment)- in USA it is easy to find venture capital, not easy in Europe, but there is opportunity for public funding, tax breaks – it is complicated for SMEs... what they can do to grow- due to variety of solutions, there are different cases; labs for universities to labs which involve investments companies which work in finance.*

*-Value, ValuePropositions; TT and KT- what else?*

*The main value of the DIH is not technology it is technology for the business; ValueProposition is supporting introduction of technology into business; they don't have to do high tech but to analyze the means of the company and support the introduction/customization/personalization of existing digital tech. Industrial Strategy of EU is based on Green Transition and Digital Transition pillars. DIHs work for Digital Transition pillar but it is a prerequisite for Green Transition (optimizing energy production, transport and reusing fuel consumption... many areas where Digi Tech can help)- one of the evaluations is how this supports Green Transition pillar. Another ValueProposition is helping business becoming greener, becoming green will soon become mandatory- DIHs should help define right digital technology to address green challenges.*

*-What are most valuable resources for DIHs?*

*People (understanding needs of the reality of area where they work, people who can understand needs and translate them into opportunities for digital tech, and have knowledge and know-how by research institutions/specialized companies who can help SMEs/public admin to introduce these digital techs into normal business.*

*-M0 DIH scheme display (explanation)+ lit list*



*Makes mostly sense. Most DIHs have regional aspects but not all of them. In NLD: 4 regional DIHs and 1 national (for public admin, because they believe public admin should be done at national level), in ITA: 2-3 DIHs covering entire country (they think should not be linked to specific region). In most cases you deal with local actors in the region, public actors and so on. Institutions/Uni- a lot of industry associations, innovation entities created to improve innovation capacity to the local ecosystem (which is public but not entirely). There is a significant part of private investment also in the DIH- not sure if all this is well reflected on MO scheme.*

*+include the suggested two pieces of literature*

*-For new catalogue, will this be interesting for structuring it?*

*Yes, it may be, but it has to be very simple; if there is a lot of effort put into very sophisticated model, it will not be too close to reality.*

*-Referent architectures will also be used - DIH RMM will be complex, but I understand that for use it has to be simple, and have instructions for use. In the real world, we need to keep it simple; if it is too complicated, it will not work.*

*-DG NONNECT=DG CNCT*

*-Core of DIH expert people (less than 20 people) work with DIHs in his unit*

*-Contact in future for the focus group? Yes*

*-the DIH catalogue will be substituted by a new version, developed by the DTA - Digital Transformation Accelerator (the support office of the EDIH network). No data will be lost: in our contract with the DTA is clearly written that they have to migrate all the data and provide better functionality than the current catalogue (which, by the way, contains a good amount of obsolete data).*

*The DTA project started working a few weeks ago, and around the end of the year they could be able to migrate the catalogue to the new platform (of course, as soon as we have a precise date, we will announce it officially). Again, it will be an upgraded version including all the data from the current version, not a decommissioning!*

2.

*-Does not understand VDML methodology, no particular opinion about it*

*-What DIH collaborations could you list?*

*They facilitate development projects between knowledge institutions and companies (knowledge institutions, research institutes) in order to develop new knowledge and also to transfer mature knowledge to industry- one of the main purposes. Some DIHs can work as centers in order to understand and aggregate the needs of industry and transfer these needs to policymaking institutions. They have business intelligence to understand development needs; target different areas which need to be targeted and developed further- so they can serve as business intelligence nodes. To develop networks between DIHs and different countries/places, and bring knowledge from different regions to their regions, so that they can be a bridge between different knowledge institutions.*

*-Do you agree that DIHs are VDS; systems that deliver values to customers? What does DIH deliver?*

*Ideally, they should be that but there is always a danger with public funding that they will cater to policy needs and not to business immediate needs, so there is danger that some of them will not deliver value. But if they deliver value, it would be support, development of skills in company, raise awareness about digital skills and processes within a company, help them develop internal processes and digital matureness, services and products (to raise digital components in products and services).*

*-worked on DIH catalogue 6 or 7 yrs ago, so not so involved with that anymore (used to work for EC)*

*-Do you think structure for new upcoming DIH catalogue would be useful?*

*When catalogue was done, DIH was an emerging term with no definition (still vague), so they could see that there were cluster organizations and incubators still providing the same services as DIHs. Maybe it is more mature now (not following it so intensely lately). For catalogue, it would be important to follow what DG Connect puts in with definition of things, like maybe different specializations of DIHs. If it would help different DIHs and/or companies looking for*

*expertise find each other, it would be of interest... using terms that industry uses as well, to define what competences and services organizations have (using phrasing that companies have when they are looking for information).*

*-no objections nor other ideas to the list of literature.*

*-M0 DIH scheme comments?*

*Change „university“ to „academia“ or „knowledge institution“ because there are different setups in different countries (in SWE is probably correct, but in DEU research institute sector, in NDL TNO=research institute is as important as university). Stakeholders look ok.*

*-What are the most important resources for DIH?*

*Competent people, knowledge but also focus (digital skills but also test beds and test environments with access to hardware for some HUBs); a) skills, b) test beds/equipment.*

*-Not familiar with referent architectures which will be used for DIH RMM*

*-How would you measure/value the work of a DIH?*

*How many companies they served, survey to beneficiaries of their help regarding the services provided.*

*-Are DIHs more related to KT or TT?*

*Two sides of DIHs: providing basic knowledge and technology based around digitalization if a mature industry needs to upgrade a bit, but there is also frontier knowledge on AI, so it depends on the purpose of DIH. Some are more tending to regain development, to broader of lifting of more basic digital skills and the other are more high-end skills related.*

*-What exactly does non-profit mean?*

*That is something that DG Connect wanted to emphasize, that ends and purposes should be more societal, the goal: spreading and developing knowledge. He is not against DIHs making profit- good in the long run because they need to be economically sustainable and not only live from the public money indefinitely, so charging a little bit of fee is ok (providing services they were really asked for)- comes again to catering more of the policy then to the needs of the industry.*

*-Are business networks more static or dynamic?*

*He hopes that they are dynamic (that they try to change and involve more partners all the time- key success factor for them), but he does not know. In his region (in SWE), there are a few cluster originations working with digitalization, and over the years they change target groups they work with; in the beginning, they worked mainly with SMEs but then they realized they were good with digitalization and then they started working with more mature companies in transforming their digital skills- they changed both the target group and which actors they are involved with- that is dynamic. Now works with regional development agency, but was involved in application for EDIHs in his region. His DIH was based on a number of cluster organizations which were already up and running- with the help of the funding, they can build a network and upgrade the services they provide- their funding is based on company membership but also funding from regional development funding and own funding (mix funding setup). There is always discussion on where the funding will come from. Few organizations come to the point where they can only live from just selling their services- they need to mix their incomes (charging a bit for their services in his opinion is therefore ok).*

**3.**

*-2 DIHs as a part of ICENT: 1. CROBOHUB (robotics) and 2. CYBERSEC FDI (cyber security); sometimes use DIH in applications, they ask for the DIH to be declared, which was especially helpful with CROBOHUB++ (projects with EC mentioned on the web page); EDIH should be focused on one of the key technologies (AI, HPC or cyber security) and they declared all three 3 and mentioned some others; EDIH services which will not be paid by customers and other users will be covered by the given money, 4 key sectors of use (manufacturing, energetics, agriculture, public administration); there should be a system for the national DIHs to interconnect and have greater impact on the society*

*-When speaking about DIHs, what does non-profit mean?*

*When applying for a project: personnel expenses, travel expenses, organization of workshops and meetings- all that is a standard expense, and then there is overhead. Horizon covers 25% of justified expenses; it covers admin fees, consumables, rent, telephony, and if there is*

*anything extra left, that is considered a profit; they consider it an income which they invest in further development of ICENT. Clients have to pay for industrial projects, in accordance with the contract between ICENT and that company. The profit it makes cannot be used in any way – when people who do the job get paid, there is a little bit left which cannot be paid through authors agreement for example – it is being reinvested.*

*-Which indicators would you use to follow the effectiveness of a DIH?*

*EDIH has some KPIs prescribed (efficiency, delivery which is specifically defined – standard parameters for measuring efficiency). DIHs should support digital economy, so then it is measured by how many companies advanced their businesses, or manufacturing, or the quality of products etc. Clients are mainly small and medium sized companies; in achieving digital maturity, the emphasis of EDIHs is on small and medium sized companies, even though it is not a strict rule. EDIHs also raise the level of maturity of digital technology use in public administration.*

*-Do defined KPIs have defined metrics?*

*The number of organized workshops, enlargement of production volume, and quality of products.*

*-What are the activities and collaborations of DIHs and EDIHs?*

*Activities (very important for EDIHs): test before invest (testing before production)- an idea can be great, but not make a contribution to production and that's why the proof-of-concept is needed before the beginning)- DIH is always some kind of network in which the most competent entity will do test before invest (the initial phase in defogging the situation). Members of EDIH are ICENT (applied research and tech development- TTO, a member of EARTO organization), FER (the main partner) and other partners like Algebra University College (vocational education), HGK, Srce (HPC), HabagBicro (innovation agency) and INFOBOP). DIH is a hub of interrelated partners and institutions- the role of DIH/EDIH is to help SMEs and midcaps find financing, investors (for extending production), networking (all who can help each other) or create some kind of ecosystem i.e., network of different stakeholders. DIH/EDIH network organizations deal with research and development of*

*technologies, network business associations, banks, universities...depending on the DIH. EDIH is a virtual entity.*

*Collaborations: with different business entities, will offer some services, DIH can directly engage in business with a company to do something, and that that is extra profit which is being charged, but DIHs and EDIHs can do up to cca 20% commercial activities (because they should be non-profit)*

*-What are the resources of a DIH (besides this financial resources)?*

*human capital: innovation center has cca 40-50 persons with different expertise (market analysis- evaluation of new technologies, legal issues, economic issues like venture builder – help for startups (education, funding)), agreements with FER, soon also with FSB (lab)- uses people and its labs trough outsourcing.*

*Material resources are modest- don't have their own labs yet (use modest ones from the university)- the solution is networking of different stakeholders and creation of trust trough that (networking is also a kind of a resource).*

*Proof of concept is the level of research 3; in Croatia on FER in ICENT, they can do proof of concept, but have no place to further launch it (cannot offer it to a company which has no human nor financial resources)- many more steps are needed for something to be launched on the market; those are levels of tech readiness 3-7, and 8-9 is more like design and adaptation to the customers' wishes. They would like for ICENT to be RTO someday. This situation should be understood by the political level also; there is no development without applied research, and infrastructure is needed for that (scientific- which is needed for example at Ruđer Bošković Institute, Institute of Physics; technological-development infrastructure- RTOs with big labs – this is where Croatia is failing, political level has no understanding- as a small country, it needs to put emphasis not on the basic but applied research). Technology is not being created at universities, but in industrial centers and RTOs, and connecting business and industry in Croatia does not go easy. USA has DARPA, as an intermediary between academic community and business.*

*DIHs can have different orientations: cyber tech, AI, maritime tech... IoT ...*

*-Do you have collaborations out of Croatia also?*

*State politics support needed (agreements). EDIHs have an important component in creation of international corridors (for example, EDIH from Zagreb has some competences which some other state does not have in some other field – cooperation agreements- this is where the improvement is expected).*

*-Literature review- probably ok, suggested another piece*

*-MO DIH conceptual level representation:*

*Include scientific, technological-development and demonstration infrastructure; key stakeholders are universities and RTOs (when speaking about technologically oriented DIHs (there are also the ones with humanities orientation))- better to put RTO instead of research establishment; model has to be open and have the capacity to be upgraded (modules); the core are universities and RTOs*

*-What else are Values and Value Propositions of a DIH?*

*Creation of awareness that something is needed (DIH, digitalization...economy, life, work has to be advanced through DIH i.e., digital technologies) in order to create motivation for that to succeed, DIH model is welcome.*

*-How can quantum technology affect DIHs?*

*The speed of calculation of new processes online and process with HPC and then with that info have an impact on the real world; digital twins concept- gathering information from the real world (millions of information pieces), handling the information with fast computers (quantum computing and quantum communications) and then acting on the real world with that info – closed circle (reality-digital/virtual world- real world); digital twin will replace human in some other process for example automatic speed control – that is already starting to happen and that is why fast computers and fast data transfer is needed. DIHs are also used for that. Fifth industrial revolution again puts back human in focus (takes in consideration satisfaction).*

*-Referent architectures? Hear about it, did not study it.*

#### 4.

*-Indicators of DIH efficiency?*

*reach to local SMEs and public sector organizations, number of experiments/services they provide to them in a specific period of time, impact of digitalization on the customer*

*reach=how many come asking for help, because DIH should be proactive and not wait for the customer to come to them, but reach out- the more DIH reaches out, the more they are known in business community*

*-How would you measure it?*

*count how many companies came for help, number of experiments in business community for testing new technologies (AI, HPC, cyber sec...)*

*-What are the resources of the DIH?*

*DIH should be a physical organization with infrastructures, should own efficient and highly qualified staff specialized in advanced tech- should provide advice and testing for specific advanced tech (not mainstream tech for commercial use), which is able to test how customers would use AI, block chain, to see how they would benefit from that tech, adequate testing and experimentation facilities, skilled staff connected to other DIHs in order to reach out for technology they don't have in a DIH*

*-What are DIH activities and collaborations?*

*activities=have documents that describe DIH categories of activities (providing expertise on specific advanced digi tech, provide skills on advanced tech, help companies find finances and support to invest in advanced tech...to be a member of an active network in order to have permanent links with other DIHs in region/country/all over Europe)*

*-Collaborations internationally?*

*EDIHs create network of 150+ DIHs all over Europe in constant collaboration, will participate in a network on European level and maybe around the world, very active in Europe and will provide service to every SME wherever it is.*

*-EDIHs get one time financing?*



*Funding for a period of 6 years (probably)-DG Connect knows, specific regulation dictates it-funded by a specific program from Digital Europe program- help building capacities in tech mentioned earlier, period 5-6 years she thinks- this is 50% of their financing needs and the other half will be covered by a national fund or can also come from other European funds (Cohesion Fund, Resilience Fund...)*

*-What does non-profit mean?*

*DIHs don't exist to make money; they are organizations coming out of research or competence centers (kind of organizations that don't have profitable aim, they are not commercial companies, their mandate is to provide services for public policy not profit). Money is to cover expenses and provide services to SMEs (they end up at SMEs)- DIHs take a small fee or no money at all.*

*-M0 DIH conceptual level sketch explanation-no specific comments-*

*-Gave additional piece of literature to be added to the literature list (Handbook for DIH/regional stakeholders- how to set up a DIH- DIHs as policy instruments to boost innovation SMEs (2020)- 7 steps on how to start from 0)- sent a link to all their publications- see if there is anything there to add: <https://s3platform.jrc.ec.europa.eu/digital-innovation#fragment-89005-poel>- DIH publications- all they had*

*-Other referent architectures which will be used? Not really familiar with them.*

**5.**

*-In Slovenia 10/11 DIHs built EDIH- consortium of 7 out of 10 DIHs in Slovenia.*

*-How would you measure the efficiency of a DIH?*

*Measuring satisfaction, online rating, 70 services, it is not necessary that company will use all of them; every 6 months change (exclude the ones with no interest, include new ones), raise satisfaction of customers (and then decide which services will stay in portfolio)- this will be created; measure the number of services provided, grouping them (how many tests before invest, how many for digital maturity...), and measuring impact on the companies. EDIH will*

*have the money and it will be assessed with JRF assessment form before, right after and six months after the service. The most important KPI will be satisfaction level and trust building issue.*

*-What are DIH activities?*

*Test before invest (form from EC): competences, consulting, use of equipment+ different services (line of journey: proof of concept, ideas, capability assessment, development of prototypes, ...environment, certification) skills and training (digital maturity assessment), JRC form for line? digital maturity assessment, digital maturity assessment by different project of EC (more detailed assessment, digital strategy, workshops open to everyone (e.g., blockchain technology). They defined 8 digital technologies they want to work on (HTP, AI, cyber sec, advanced digital skills, blockchain, IoT, robotics, big data), focusing on 4 sectors (agrifood, manufacturing, tourism, health). Then there are closed workshops tailor made for companies on different thematic. Third pillar is business support for finding investments. There are also teaching workshops: how to build business plan, how to open business facility, strategic intelligence reports, possibilities of funding, researching alternative ways of funding (crowdfunding...), involved in Enterprise Europe Network (University of Maribor is a partner)- 42 laboratories from cca 70 universities, and cca 200 researchers with competences, supercomputer, digital equipment, new tech available for commercialization, DIH platform open to other ICT service providers (have to pay to be included in DIH)-----*

*-What are DIH collaborations?*

*Strategic research partnerships ...all working together, Slovenian DIHs are partners, working together with many DIHs outside Slovenia, on different topics (joint projects under Horizon 2020 or Digital Europe Programme, the exchanges (lot of requests for people to come and see the super computer and receive the training), organizing digital innovation competitions with other DIHs (involved as international jury), developing joint services (codeveloping methodology for AI human resources assessment- how people are willing to accept AI-something that will not replace them in the work place, but help them). There are many collaborations with other EDIHs. So far, DIHs did not have funding and did not collaborate with DIHs out of Slovenia because they had enough domestic issues. EDIH will do that.*

*-Something to say about DIH as a non-profit one-stop-shop?*

*They charge ICT companies (service providers for fees), if they want to join consortium as outside partner they sign agreement and then EDIH promotes them to the Europe- if they want to for example break into German market, EDIH in Slovenia finds EDIH there. Fees are used for the functioning of the DIH (salaries, organization...)- completely non-profit for now, but are building a model which will make it commercially viable in 6-7 years. Right now, they are just testing to see which services they are really good at and which companies are going to be willing to pay for.*

*-What are Values and Value Propositions of a DIH?*

*TT, to outsource the knowledge of the researches (KT). Slovenia has advanced western region (in GDP above EU level) and eastern is below, so the focus is also to help the region- regional growth.*

*-Other referent architectures which I will use- Maja's thoughts?*

*She heard of them, they use some of them, but researches use them not her- DIH office is only broker office, managing DIHs. More technical things are solved by researchers.*

*-Will let me know if there is anything else to be added on the lit list*

*-DIH M0 conceptual level depiction- any thoughts?*

*Maja thinks DIH is like a cloud; brokers (she and only her 5 broker colleagues) external are all the ones that re not direct partners. The other internal circle are their researchers (experts), ICT service providers, companies as partners in the network (everyone who can offer something)- this is all a part of internal ecosystem (if you have a partnership agreement with business incubator, chamber of commerce... they are all a part of internal ecosystem, but if there is no partnership agreement, then they are a part of external ecosystem weather it is a part of someone else's ecosystem or not. Whoever is in the ecosystem is internal. External environment are other DIHs all over Europe with their ecosystems.*

*-Did not happen yet that they can't help a client. Clients mostly come regarding finding problems, but then they attract them also to show them what else they can offer. They prepare*

*companies for investor conference in Maribor to get investor for developing of their digital technologies only.*

*-Green technology is also very much in the focus- will be a priority in EDIH.*

*-They are very active in DIH promotion: web pages, pamphlets, newsletters, mouth-to-mouth promotion.*

### **Notes taken during the second part of interviewing process:**

#### **1.**

*-The institute has one DIH (was created based on one EU project) and EDIH in the area of health. DIH is a partner of that EDIH, provides support in the area of AI, HPC and provides support to medical SME companies and clinics which are developing new innovative diagnostic methods and instruments. DIH is oriented toward technologies, and EDIH towards the application of them.*

*-What are the activities of your DIH?*

*DIH gives support to SME companies in the area of HPC, TT towards SMEs, organizes educational meetings, common European projects with partners (mainly SMEs), advising, use labs of the Institute which has a competence center and center of excellence, work on the E-Lab/Smart Lab concept, mainly through discussions and developmental activities, they provide HPC resources for calculation needs of SMEs, software and hardware support and consulting.*

*-Do you have any business networks?*

*DIH for Cyber Physical Systems (CPS)- they entered their business network through which they further act in the way that they get one partner from every country and create comprehensive European network CPS (IoT and other with sensors, sensor network etc.) and application of modern technology in those systems, and they support through AI and HPC.*

*-Any collaboration in some Community of Interest?*

*Created a group for development of shipbuilding companies, held workshops on that subject, have collaboration with colleagues in Serbia in robotics, in Hungary in clothing industry (custom clothes made with 3D printer- originally development started in Israel), in Slovenia in health (software for mobile Holter monitor, through contactless communication and then a cloud communicates with the doctor). DIH works a lot with companies from Zadar on optimization of engines of processing machines (numerically controlled, through AI they do malfunction predictions), with company in Slavonia on detection of urgent conditions on the roads (with the help of AI, cars would through the camera register holes and obstacles on the roads, data gathered was collected in the database, road analysis was conducted and in case of irregularities, that part of the road would be marked on the map and displayed publicly).*

*One of the strategic determinants is also creation of certain models- how can logistical streamline be given to DIHs, and also how can collaboration be achieved with public administration- DIH procedures and projects. DIH can help a lot with business development' that was already proven and they have reviews for it. It is easy to discuss that if they have DIH models of classifications and qualifications. EDIHs are also not well made – they were assembled too fast. Through a DIH model, clear and high-quality concept aligned S3 strategy of republic of Croatia should be developed, and then that is how EDIHs should be approached. Some DIHs were created, which do not have the right direction.*

*Model should include both DIHs and EDIHs, because DIHs are pillars, and EDIHs are platforms on those vertical pillars. DIHs cover the technology, and EDIHs with those technologies develop applications; it is a system of DIHs which includes both DIHs and EDIHs, because it would be difficult for EDIHs to survive alone and function on the European level without DIHs. Established networks create real developmental support to economy and society, and it is necessary to create the catalogue with horizontal and vertical support (operational ecosystem for the development of Innovation Europe). National filters should put in use their filters and then those entities should be unified in European network. Every nation has its own S3 strategies, possibilities, endeavors, personnel and everything else, and DIHs should be raised, operationalized and networked in regards to that and for developmental policy accordingly. The cluster of DIHs is a good initiative.*

*-Mipro conference and CroAI are trying to orient Republic of Croatia towards smart industry development in which DIHs are an instrument of development. Unique attitude would be created for advancing forward. The suggestion is to create something what will help this country, do DIHs can be positioned in public administration on scientific, technological and methodologically sound basis. An expert group should sign such proposal which should be considered. Knowledge, technology and personnel which can articulate solutions of general state interest exist, and should therefore be enforced.*

*Key performance indicators (KPI)- if we were to put them together, then with such a document we could submit it to the chamber of commerce and the state administration to try to recognize and operationalize these DIHs into various programs. Croatia needs a strong DIH network that brings together experts with various knowledge and makes it available to the economy, and the economy and science should support this. The future needs to be profiled, especially when there is intellectual capital, which can shift the economy.*

*-What are the indicators of efficiency?*

*DIH has to have: the European project (min 1, otherwise it is not present on the KT market), must be bound in the network, must have cooperation with the academic community (KT and education) and the economic community (expertise and TT)- these are 4 necessary indicators and it is necessary to satisfy them all. Other things that would be good, not necessarily: to have a project in the internal market (then it uses the internal budget, and it would be better to use external) ... to have a project that it received as DIH and a project in which it is a partner as DIH (to help the secondary)- must be directed towards the economy and have an impact with the academic community...4-5 DIHs and 4-5 EDIHs connected vertically and horizontally would be an ecosystem that can move the economy - this is an established force.*

*-Value and Value Proposition?*

*KT, TT, on the website stated (not updated)- DIHs should have defined strategy and cooperation with public administration (academics, economy and public administration, because there are concentrated experts) ... in the system of DIHs and EDIHs, professional associations would also have to be established by (e.g., CroAI), which would also have their own significance. DIH cluster should be systematized and connected horizontally and*

*vertically, with professional associations; it is a strength and a good way to recover. CroAI has considerable strength... we have the means to prove the truth and lead to certain structures. It's a shame that some DIHs are floating, some don't know their way around or forget that they are DIHs, and it would be necessary for RH to wake them up and strengthen them in some way and to take a step forward.*

*-focus should be on big push development (like Rimac), not on the slow rise - S3 is formed in that way*

**2.**

*-No extra benefit to be on the list for EDIHs- funds from EU, terrible to access the funds, EU is very bureaucratic organization and not working very well. They are public private partnership, so they have partners (local cities, hospitals, companies) and they give budgets and sometimes regional possibilities for funding. Sometimes have events like hackathons and they get some money, but main source of money is public and private companies/organizations, and startups they work for is for free and besides non-for-profit business, they have their own small investment funds to invest in startups.*

*Local authorities think you don't exist if you don't ask for money and follow guidelines from them. If you want to be funded on a big scale by a government or EU; you also need a lot of people to manage this (all these proposals, paperwork- this is job besides the job- a lot of work).*

*-DIHs are on profit, so what do you use the money for?*

*They don't make money, if they make it- it goes back to their work and health startups, marketing purposes, even based purposes, not profit driven.*

*-What are activities of your DIH?*

*Digital transformation of healthcare system, so focus is healthcare and the main focus is helping startups from idea to receiving capital (they have their own accelerator projects to incubate them from idea phase to sessions of few months, experts) active with universities, schools to get students involved, to get new ideas coming from students, matchmaking*

*speedates from students and startups and healthcare organizations- lot of facilitation and intermediary-ing between startups, customers and market.*

*-How do you ensure efficiency? Indicators?*

*Indicators: number of new startups we see, investments in startups, participants at the events they organize- not well defined yet, fur working on it.*

*-Collaborations and business networks?*

*Work with Brightlands in Netherlands (5-6 different topics/activities, startups in healthcare/new medical/chemical issues), mostly intellect-based projects. Main focus is Belgium.*

*-Who are customers mostly?*

*Startups, people already working in hospitals having ideas, students, entrepreneurs, pharma companies with innovating ideas who want to see how to incorporate their ideas in working, organizations who want to invest in startups, students, universities...*

*-What are resources of DIH?*

*Fees, partners who pay yearly amount of money depending on their interest (membership fees).*

*-What digital service do they ask for?*

*Not focusing only on digital solutions, but business aspects. Business in healthcare is more complex. Solutions are more and more related to AI.*

*-Do you use university lab?*

*Startups have mainly very good understanding of tech, tech is no problem, the problem is access to healthcare and customers, how can we use certain tech for a problem. Students (PhD, M.S., Prof)- innovation boot camp, hackathons- use expertise of regional universities to help out with the problem.*

*-What is your Value/Value Proposition?*



*KT, business plan, access towards difficult to reach lobbies and first customers, lobbying towards local governments, payers, - facilitating access, building benchmark (if approved by Blue Health, then access is easier- screening)*

*-Quantum comp/comm?*

*Will affect them for sure in future, bioinformatics (faster calculations), medical imaging will benefit, but not every problem in healthcare can be solved with very advanced tech (legging behind 10 years when compared with state-of-the-art technology). For medical technology and pharma quantum will be big advantage. We are using start of the art technology in certain disciplines like medical imaging. Hospital as a whole works very old school, mostly written documents. Scandinavian countries are the most advanced in this way. Also, Asian countries. Western world has hundreds of years old hospitals (legging behind also because of these reasons). Tech is evolving fast. Virtual hospitals- everyone at home, monitored from one place.*

*-How do your clients find out about you*

*In Belgium and Flanders, they are very known (exist for cca 10 yrs)- already have the right partners who spread the word, visit fairs and events, PR and marketing about activities. They are one of the first providing for healthcare.*

*-Are you aligned with state S3 strategy?*

*For country- yes, because from the beginning, Flanders government in order to provide initial funding required that they are aligned with S3 (said healthcare will be one of the key domains (clusters)- spearhead booster). Healthcare has always been an interesting topic for Belgium, has very affordable healthcare people and tech can help, coping with changes without changing is difficult, tech should be welcomed).*

*-Did you have any projects related to pandemics?*

*EU based hackathon (?)- they were advisors, their own online events for students and startups to reduce the lack of information, do everything that was physical before (hackathons, speedating)- more participants on online then on physical events, easier to reach people, new people involved in working (if you are at home and nothing else to do, you see what is there)- one of the first ones with online events.*

*-Did you work on any remote healthcare solutions?*

*everything where there is physical parameter you can do remotely. Chemical parameters...covid test for at home and make a picture of it-all that has to do with online consultations, mental illnesses can be done online. Have startups working on all solutions, app for prescriptions. Technology was never a problem, but the situation of pandemic worked towards embracing of technology. Algorithms for medical devices take a lot of time and money to be approved- legal issue (who is responsible and liable). You get a risk factor and you need a doctor to follow up- who is responsible if the doctor is not involved? General public should be more aware of what is possible with technology. Human doctor is still necessary.*

**3.**

*- They are primarily an entrepreneurial incubator, but also DIH (now EDIH)*

*-Education - training people in various digital skills (digital literacy) and incubation (support for small businesses to start, financing, training, space). Education in game development - people who come generally do not have much knowledge in that area. They have their own experts (video game development - educators, and they are also mentors to startups in the field of business. Meetups, connecting with investors...*

*-They have their own premises/infrastructure. As a business incubator- three buildings, their equipment and educators were financed through an EU project.*

*-Clients are new companies (SMEs, startups, 90% are newly founded companies by the participants of the education).*

*-They have nothing to do with public administration, the focus is on SMEs and education. But since they became EDIH, an important part is public administration, so they will focus on that in the coming years.*

*-They are non-profit, education is free, but incubation is charged at symbolic prices (no profit is made, the money goes, for example, to renting space).*

*-Funds from the EU are strictly for specific purposes (construction, equipment, expert supervision - they have foreseen everything), a lot of bureaucracy, strictly controlled.*

*-They had indicators of effectiveness at the beginning, they are still monitored, and they also have them for EDIH (they are high and must be fulfilled, it was not based on them that they received funds): 1. number of companies that provide services (the methodology used to measure the impact on them - digital maturity assessment - the structured form is the same for all EDIHs - before and after - this indicator includes a certain number of SMEs and public administration entities), 2. the second is the number of additional investments that they encouraged with their activities (they gave someone education in e.g. gaming and then they made it possible and attracted more investments), 3. the third is cooperation with other EDIHs (EDIHs must cooperate with each other - this was stipulated by the tender - a complementary network of the EU, so that things they are not instructed in can be referred to someone else). They haven't received the form yet, it is under construction, they will have a digital transformation accelerator service and it is still under development, the form should be available at the beginning of December 2022.*

*-For the purposes of applying for EDIH, they established contacts with two DIHs from Slovenia and one from Spain, permanent cooperation did not take off, but they only agreed on cooperation in principle.*

*- From 1.12.2022. the work of EDIH started.*

*-Collaboration and business networks have not started yet, but have been agreed upon for the future.*

*-Resources: space, equipment, people (expertise).*

*-Value/value Proposition: KT, TT, through EDIH, will acquire additional equipment to be placed in the incubator, demonstration activities with which they will demonstrate some technologies with the possibility of concrete KT, regional development (revitalization of the area), raising awareness of DIHs.*

*-The gaming market is not limited by national borders; the market is the whole world and digital platforms.*

*-The gaming industry is bigger than the music and film industry combined, and they were looking for a new direction of development for the county, if they had opted for IT, they would have had a hard time competing because IT is everywhere. People move to Novska and want to engage in gaming. It's the same competitive area, but residents don't have to strictly do video games, it doesn't have to be strictly gaming, it can be various visualizations, creating various applications with augmented reality.*

*-The experts they train stay in Novska - Novska becomes attractive because there is a gaming community there, and then those they train can communicate together and exchange ideas, meet, arrange cooperation, and some go to Zagreb, where there are a lot of studios dealing with game development and they get a job there, but there aren't too many people who were educated there and have left.*

*-2 basic programming tools they use and base their education on: Unity for programming, for creating graphics and models Blender, soon another program.*

*-Mostly the clients are young people, some have some knowledge of IT and gaming, but most of them have no experience and knowledge, they have been playing games all their life and want to know how to do it (enthusiasts) - they are not immediately trained for block buster after 6 months of education games, but they are for some minor things, they need additional education and practice, but they can work in IT companies that deal with gaming and have a good basis for the job market.*

*-Matchmaking- they cooperate with the Croatian cluster of video game makers, through that cluster they create contacts with studios working in that area (there aren't many of them), many clients contact them themselves, organize meetups, sometimes bring investors and make teaching sessions to connect.*

*-The EDIH grant was obtained for three years, there will be tenders that will be able to extend the EDIH for another year, and then again for three years. But there are also other tenders, such as from Digital Europe, where various educational programs can be developed, for which you can now apply, etc.*

*-Should DIHs be abolished and EDIHs left, or do you think that horizontal communication is important? They should be left, because they can become EDIHs, and some can act as DIHs,*

*we should leave a branched network and give DIHs more visibility and give them importance, especially in our country where public administration is not really digitalized - we need DIHs to give importance.*

*-HGK and the ministry will be able to give DIHs more visibility and should certainly help in giving visibility.*

*-The incubator is from 2016-2017, three years ago they became DIH - nothing official has changed radically in their activities, they were only registered on the s3 platform three years ago, and in principle they have been since the beginning - this helped them in getting clients.*

*-This summer they had a gaming camp for elementary school children (huge rush) - they were recognized.*

*-EDIH will primarily focus on AI, and the primary group is the development of video games (giving them additional competencies), but the focus will also be on traditional sectors (wood industry, agriculture - AI solutions), autonomous driving, digital twins, etc.*

#### **4.**

*- they didn't become EDIH, poorly made selection/structure; the idea was to cover the whole of Europe both thematically and geographically, so now the EC is still considering what to do - the selection should be made differently - they will apply again next time - it is difficult to make a competition that will cover everything*

*- How do they measure efficiency? They don't measure.*

*They are located in the Republic of Croatia, and the Republic of Croatia is not good at networking and cooperation, they have a large network of people and connect them well. They discovered that there is a label "DIH" as a facilitator that will work to make people better connected and the emphasis is on digitization. They are good at connecting interesting companies, tenders... they are looking for entities to work with (with FER... companies...) they will prepare the papers and secure funds. They find someone who has a need, not necessarily a project. They do matchmaking, speeding, tenders from Brussels like the Horizon program. They are a private company, not a public institution - they try to do as much as possible with*

*the people and resources they have. They are not that old, they don't want to be a big organization - they leave that to someone else; they do a little more excellent things, they are proactive (assertive). They do not give lectures, they are there to help, but they are not a public and constantly available service that must help.*

*- What are the financial resources?*

*They are financed from the project, they do not charge the clients, but they will either be a partner in the project or they are already engaged in the project and bring in more clients/partners/institutions. They are not a service or a large organization (nor do they want to be). They are trying to win cooperation with FER and IRB, and they count on finding financing, and for now they are working pro-bono.*

*-Resources in general?*

*Projects, premises from the company they work for (which is a subsidiary, consulting), human resources...*

*-they deal with: bitcoin, bitcoin, food production on land and sea*

*-contacts with the University of Split related to shells...FER...Adrion program (master's degree in robotics and other new technologies from the Adria region - five universities)*

*-Drones?*

*Regarding drones, they have cooperation with Lithuania, the Alpha Sagittarius company from Split (Fixed wing). There are a couple of companies in the Republic of Croatia dealing with drones in the food domain (not very well developed), Agrivi... They organize the story, so someone delivers the drone, someone the software, someone the sensors. Analysis of real honey with spectrometry (so that it can be determined whether the honey is real or artificial)*  
*- a company has developed software that puts samples in the database and then creates/searches for samples with AI - customs could use it.*

*-Who are the clients?*

*There are no rules, it depends on the team/project. They cooperate a lot with teams from colleges and universities, look for people who want to do something interesting, and*

*occasionally work with the public sector (county, ministry of education...). Both clients and partners are in and outside the Republic of Croatia. They cooperate with other DIHs (business network, collaboration...part of the SMARTDIGI HUB network, they try to gather DIHs from the AgriFood area - about 20 of the strongest DIHs from the food domain. They are not officially part of any interest community.*

*-Reliance on laboratories?*

*Mostly with FER (labs for underwater systems, robotics and sensors), UniSt (sea department), they are trying to coordinate a project with the University of Dubrovnik, they haven't worked with Agronomy yet (they don't need it), Food and Biotechnology - they talked to the dean, but they have started is called in the newspaper, so better not. Through Horizon, they work with serious institutions in other EU countries. Digital education also runs some programs related to food - universities from 5-6 EU countries. Most often, they find them because it is very important to them who they work with (someone who offers something interesting in terms of technology/solutions...). Panels and presentations sometimes result in collaboration. They haven't worked with insurance companies so far, maybe they will in the future. National funding was not really present until now (for land-based food production), so they used ad hoc tenders to get funds.*

*-What are your Value and Value Propositions?*

*Facilitation (they are very good at finding a team and do a lot of work in support and solving additional concerns) - there is a great need for this - they encourage and organize them; they want to make a positive change.*

**5.**

*- 4 EDIHs in the Republic of Croatia, such were the quotas in relation to the size of the country (Finland is the same size as the Republic of Croatia, you get a budget and you can make two large ones or 4 small ones - MINGO immediately said 4 small ones, to satisfy as many applicants as possible), either 7 initial applications (at the pre-call in the Croatian qualification part there were 7 or 8 candidates - some failed the admin check and there were 5 left - the Republic of Croatia chose 5 candidates and it was known that the EU would choose*

4 - fifth is from Split (I guess i.e. I guess Blue DIH, whose base is UniSt) - they did not receive funding, but they received the Seal of Excellence because they crossed the threshold of the number of points) - they will most likely be financed from some other sources.

- What are your performance indicators and how do you measure them?

By definition, EDIH must have 3 of them: 1. how many SMEs did you pass through the system and for each one you have to measure digital maturity at the beginning and at the end (DTA tool), 2. financial - how much money did you manage to attract as a result of the work of your EDIH (a consortium is formed, an application and access to funding are written for each SME I work with and then how much money did you manage to withdraw, i.e. how much did you manage to apply for) + there are some more...

IRB EDIH has the only strong public sector component in the Republic of Croatia (the DIH letter is focused on gaming, Rijeka on industry, FER has nothing, and they are digitalizing healthcare (workers, and indirectly patients) - to normalize digitalization in healthcare - both doctors and patients need to become digitally literate

-their main clients are not hospitals but start-ups that make solutions for the medical sector, and they don't have to work for the hospital, they can work directly for the patient

-the question arises as to what is AI in healthcare, and what is AI in well-being (it is necessary to demarcate) - an analogy would be a comparison of drugs and over the counter preparations -one has one set of regulations, and the other has a different, milder set and is not Also, is AI used for diagnostics or improving the quality of life - the idea is that IRB EDIH helps them to develop these ideas sooner and to enter the market as soon as possible. To enter the market, you have to be approved by HZZO, you have to be "billable" (e.g., have the category "glasses"), and no one in the Republic of Croatia knows how to test AI technology in order to obtain a billable category (because no one yet he never made it) - when that is arranged, the whole process will be arranged what and how to do it

-MINGOR manages the money (EU, HZZO), but the Ministry of Health is behind them and they have people who deal with digital health and who are interested in changing it

-nothing works without a human doctor, but many are digitally illiterate even though it would speed up their lives so much (and they are afraid that technology will replace them, they need



*to change their mindset that it will help them, not that it will attack them - changing mentality through education)*

*-educating new doctors already at college, creating digitally literate doctors (started with UniSt) who will no longer even doubt it - change in awareness among the public and medical circles, as well as patients*

*-AI is a bogey because they don't know it, it needs to be debunked - you have one great opportunity to do the right thing, so that you don't lose trust in people and in science and everything, but it must not turn out badly, so that you don't lose trust - that's why it's terrible it is important to release first solid efficient and transparent good examples (not abstract and metaphysical, but something that actually works). Maybe the typists will lose their jobs, but the doctors won't, they will be able to examine more patients a day because it will be easier for them (and this is important both for patients and for the health and financial system)*

*-What are your main activities?*

*Test before investing, access to finance, skills and training and networking. The biggest hole and fast demand at the moment is the test before invest in healthcare (because it is a niche that is terribly difficult to satisfy - you have to play with technology to get to a commercial product, and you can't play with patients and doctors - you have to create sandboxes (safe environment to pay) with data, go virtual, with patients, i.e. have the opportunity to create a mini test environment - you have to have a very mature product in order to do a clinical study and these are already high TRLs, and we are talking about low TRLs - with these - the idea is to create that environment, to arrange the data and to get sandboxes so that someone can download a million recipes and do some kind of statistics on them, which you cannot do in the Republic of Croatia today. The idea is that test before invest should be their main focus, access to finance is specific to high-risk obstacles because AI is high-risk, as well as healthcare and then they are cut off - a social skills component is needed. Skills and training are very multidisciplinary (basics of digital literacy that they could be users of AI). We also need to educate the general public, and doctors are not exactly innovators and shy away from all that. Networking is still their greatest strength.*

*-Do you have any collaboration/business network outside the Republic of Croatia or only inside?*

*They have both inside and outside the Republic of Croatia - they networked locally with whoever they can (data, digital healthcare, data standardization..., DIHs as community of interest, working groups, some associations, etc.). At the European level, they connected with EDHs that do similar things, EU Connect HealthAlliance (which deals with digital health at the level of the whole of Europe) and IT HEALTH... European EDIH Infrastructure Community, IoT for Life which deals with the cloud with Life Science for Life (joint position on the AI act).*

*-Safe environment - where are the digital twins?*

*They haven't come to that yet.*

*-they try not to invent hot water - they contacted the Finns who have the best DIH and it was still in the area of Health (Health HUB Finland) - they will offer them their registries and know-how to build their registries according to theirs and then merge them.*

*- Quantum computing and quantum communications?*

*Not known. Their focus is AI and HPC.*

*-What are the Value and Value Propositions of your DIH?*

*The digital maturity of all stakeholders in that stakeholder environment (because each of them can have a lot of benefits if they become digitally mature), and indirectly they have strong ICT and many of them want to work in healthcare, but shy away from it because that field is very unorganized and highly is risky. They could become the leader for AI in Healthcare in Europe - they can stand out and position themselves and become a test bed for a large part of Europe (there is a lot of interest and very few places where it can be done).*

**6.**

*-when they started dealing with the activities of DIHs, they concluded that they are DIHs, it became self-explanatory (around 2015, the Sesame Net project - aimed at connecting SMEs),*

*based on the projects they were classified as DIHs - from European networks received an invitation and were classified as DIH (recognized externally)*

*- the "DIH for CPS" project - they received a project within the Second Call, where they included 7 new DIHs (including them) - the task was not to solve a problem (as it usually is), but to use their methodology the classifications of DIHs define and are part of the network and are read according to some of their principles - they will check with the object if they can show me the graphs (it's the same in a way as modeling, i.e. describing DIHs - first they sent them some template in which had to enter elements such as activities, elements used in the laboratory, etc., received tables with columns and categories, arranged graphic boxes and received a grid, i.e. model/portfolio- they had wild roles of DIHs; customer-user (all companies that turn to DIH for expertise that then helps them to be better in production, users of the technology that we give them and which we control and technology-provider (users who, with the help of DIH, who want to present their technology on the market) - as DIH it was necessary to define itself in each of the individual phases (in the first one they get to know who deals with what, in the second they set up contacts to see which technology they could use, then in the third they have pre-experiments, in the fourth they look at the results, and the fifth is going to the market) - using the houses, they then looked at which of all those phases of users or tech providers they as DIH could help and that was the purpose of working together through several workshops, where they presented their model). At the DIHs from the first call, they were shown their such structures (which they call portfolio), so they had a lot of examples of how to create their portfolio, present it and become part of that DIH network. The main idea of the second call ended with that - it helped to define them all together and see where they are complementary, where they are different, and where they match - a very well-structured way of presenting each DIH, so that they are comparable.*

*-EDIH covers Health (not well-being), it is very narrow (it does not go as wide as the one on the EFR) - maybe it even has too many partners (all Health Centers, HZZO, hospitals... Katarina Hospital) - they don't know where to be the center of gravity (one issue of healthcare or more broadly) - AI and HPS in healthcare*

*-Link DIH and EDIH to the IRB?*

*DIH is specialized in a certain area and each DIH is a support for EDIH which is defined in a certain application (it can use certain DIHs within itself)*

*-Cooperation with other DIHs in your domain in the Republic of Croatia and abroad?*

*They did not yet have DIH-DIH cooperation, but they had external DIHs as support on projects (they had a project that DIH was assigned to help) - they did not work together on the project with other DIHs.*

*-Is there a financial link between DIH and EDIH?*

*No, EDIH is financed for their tasks, DIH does not really have a financing method. DIH projects in the Republic of Croatia define their functioning by means. In our country, the financing system of DIHs has not yet been resolved, but he thinks that it will be (as competence centers and centers of excellence that have support). The functions of DIHs will not change just because EDIHs are created.*

*-What are the performance indicators and how do you measure them?*

*In implementation (projects, results, helping someone with their technology). DIHs are technological structures whose task is to offer their skills to someone else and help them. They had a project e.g., with a micro factory; they started as a partner in the IRB DIH project and in the next phase they got their own way.*

*-In what way do you think that quantum computing and communications will affect the work of DIH and can we talk about the concept of digital twins when we talk about EDIH in the field of Health?*

*We can, it all depends on what area someone specializes in, what niches you have chosen. They are oriented towards HPC (it is their core business). Depending on the needs, DIHs will also be formed.*

*-What is the Value and Value Proposition of your DIH?*

*KT, skills (had a lot of HPC workshops)*

*they have always been someone's support (originally to scientists through the computer infrastructure and that is the role of the center (tech oriented) as opposed to the institute (scientifically oriented)).*

*-Are the clients primarily from the Republic of Croatia?*

*Yes, except when they do scientific projects, then they work with external partners*

*-Cooperation/business network with other institutions?*

*Yes, a lot - Competence center for HPC (networks the whole of Europe in the area of HPC), institutes, faculties, companies, providers...*

*- Projects supported by public administration so far? There were none.*

## **7.-9.**

*- How did you send performance indicators and how do you measure them?*

*Elements were default; test before invest, support activities and skills development activities. In our EDIH, partners are InfoBip, Ericsson, University of Pula.... It was predetermined what are the maximum funds for which EDIH can apply. On the one hand, there is the academic world that would reduce it all to education (because they have more or less everything already developed there), and the delta for each conducted activity is relatively small (a few hours of classes, etc.), the test before invest is the more financially demanding part (they have mostly concentrated on the Adriatic Republic of Croatia, but they are not technologically developed enough nor are they large enough to serve only Adriatic Croatia). Searched for synergies across Europe in order to expand synergistic effects. They went in great lengths also with colleagues from the local administration, especially at the county level (they were in the process of creating a county development strategy), rehabilitation of the university in Rijeka... analysis of the comparative values and shortcomings of their region in relation to Croatia primarily, but also to the wider European circle. In the end, they concentrated on transport, i.e. especially on the maritime sector, they should create additional value through digital technologies, they narrowed down to shipping in a narrower sense (containers...multimodal...), health and quality of life is another focus area ( there are*

*traditionally scientifically strong - the University is a strategic partner, the Adriatic Galvanic Laboratory (pharmacology equipment), digitization of everything in healthcare (AI)), the focus is on the transition to green and the third area is energy and the environment (also with a focus on green, energy self-sustainability have a regional energy agency). Gorski Kotar is their silent suffering (more and more uninhabited places...- less present).*

*-Call defined the KPI, a certain number of companies are expected to improve their level of digitization, the number of people who will be educated... Their biggest challenge was to find the optimal balance between the number of indicators and the size of the budget and project evaluation. It was a challenge not to promise too many indicators, because if they don't achieve them, then they have a problem. This is EDIH and it is a unique experiment as a type of project in the EU, because they have to justify the budget not only with costs (salaries and bills) but with delivered services (each must have its own price - the big challenge was to formulate the service price level so that it reflects the value which will be received by companies, because due to the financing modality, 50% of the value of the price of the service is de minimis support). Maybe not all elements were defined like boot camps for preparing companies to transform them from "I have a desire to digitalize" to "I have a basic project for digitalization" so that they can even be taken for test before investment activities. This is perhaps something that others have not done, this is some part that was tried to be done, so that things would be operationally functional as much as possible from our side. We are a small partnership compared to other EDIHs, which he hopes will contribute to operativity - regardless of the fact that there are few of them, he has respect for the organizational model and how he will communicate and distribute information, and the schedule of duties and feedback and responsibilities. There, indicators will be better used to bring order to the importance and functioning of EDIH than they had any possibility of creativity in relation to EDIH. the first step is the digital maturity assessment (assessment of the digital maturity of the organization they will work with) - it must be the second and third steps to see the delta. They concluded that there is no value created there and that they will do it for free because their users will run away i.e., maybe they will want it the first time because it is a condition to continue working further, and after that they will ignore it and have a problem reporting what is their proof of loyalty to the EC and the justification of the Euro, which they hope will be obtained without major problems. As for the indicators, there was no creativity - it was more about defining*

*processes and procedures and balancing the relationship between indicators - which part of the value of the project will be realized through test before invest activities, how to formulate the test before invest - that is not yet clear to them either, defined through the amount of support given before test before invest...about 3000 Euros because X people will work there..., then they wrote that the test before invest is 20 days on average, and it can be from 15 to 30 - they tried to keep what more flexibility possible because they have no idea how things will work when they start). The framework is set, and everything they could reduce they reduced not to be overly ambitious, and that is perhaps their biggest fault (although he thinks they were terribly ambitious regarding the state of our economy and the state of the public sector when it comes to digitization, but when you look at it from the perspective of the evaluators, it's not exactly a level of ambition. They will easily deliver if there is more. They tried to arrange all activities in processes to see the interrelationship and where potential users generally enter our system, where the first contact will be, how the customer journey will be done and how someone who is being assessed will be transferred, then transferred to the technology company, then returned back, so it's business development ... there will be a lot of things that have been worked out in theory, and will be seen in practice from 1 Jan 2023.*

*-As for the evaluation, they said that they thought about whether it was really that or if they wanted to boost the numbers. Before giving them the KPI, they really did a detailed analysis of our economy (they have their own focus area and what we actually have there) and from that analysis came the numbers, they didn't pull them out of nowhere. So, due to the number of companies and their current level of digital capacity, anything else is not realistic. The way they wanted to approach EDIH is in a way that all partners do something, and EDIH will bring some kind of added value, that activities, capacities and knowledge will be centralized through EDIH in order to provide some kind of complete service to those companies, from giving them make a digital maturity assessment (so that everyone knows where they stand), to the point of educating them so that even those who may think that they do not have digital capacities in the industry and that it is their focus actually, see where they can develop in terms of digital projects, so that phase is very important. At the beginning, they will provide activities to all levels of digitalization (regardless of the stage), but they want to initially ensure enough education, breadth of knowledge, enough companies to include in order to ensure in the long term as many companies as possible with whom they can work with test before invest activities.*

*Under the given conditions, they did the best they could and maintained maximum flexibility, the possibility of redistributing activities and at any moment they will offer an extensive range of activities, so that every company can find something suitable, and not just wait. They are seen as an experimental body with a well-ordered story that allows for some flexibility. The analyzes are based on the Northern Adriatic and the Adriatic region, but they believe that there will be a need for their services at the level of the whole of Croatia. They also cooperate with other EDIHs and believe that there will be space at the European level for what they will test and do with their EDIH.*

*-Before you became DIH, what were you before that and did you have any indicators of your own even then? So, the story is well developed in theory, but in reality, you don't know how to measure KPIs?*

*No, they know exactly how they will be measured, what they don't know is how they will be reached (it is undoubtedly clear how the indicators are measured - it is prescribed and will be proven with de minimum vouchers i.e., statements about the delivered de minimums). It is clearly defined who can be users - only legal persons (whether private or public and their employees), private persons will be given a de minimis certificate, public will not because there is no need, but the logic of measuring what has been delivered is clear. It is not clear what the optimal organizational model is - because they have six diverse institutions and two universities, each of which is specific in its own way. They are a technology park that has its own scope of activities and certain indicators that they have started to monitor in order to show the impact and to know how they function, and then the university, as their owner and founder, accepted a good part of these indicators. They were never DIH. The university had a TTO office, which was changed as an internal body. They strive to function as connected bodies in terms of business processes and work and support, so that no one feels the difference between them. The others were not DIH, but have certain parts - the University of Pula has certain parts that deal with DIH technologies/informatics as a scientific institution, smart 3cluster that dealt with smart city technology, but they were commercial companies that did what they do. As a technology park, they were thinking about DIH when that story started, but even then, there was a problem that it was unclear what DIH was, so they didn't know what they were getting into. When EDIH was developed as a concept, it was undoubtedly and*



*unequivocally organized even in the rudimentary phase, and it seemed to everyone in parallel that it was something important and useful that should be used. Previously, they supported activities with 3 programs, but within their usual activities as an entrepreneurial institution, and the university has HPC and a center for advanced computing AI, which on its side does this at a much higher level.*

*-For test before invest, do you use university infrastructure or do you have any collaboration with other larger laboratories/universities?*

*After the initial triage and digital maturity assessment, there will have to be some form of organizational agreement or body that will then distribute individual tasks to partners who have the capacity for tech support, which are parts of universities (in Rijeka and Pula), InfoBip and Ericsson Nikola Tesla - each of them is specialized in something, sometimes they might even work together on something - they expect that they have very valuable competences and tech knowledge that do not exist in the scientific community, because tech is very often developed in companies and vice versa, and there should be benefits there for both, because there should be an internal TT and KT.*

*-They estimated that they have all the necessary equipment as a consortium of partners, but they also have all other EDIHs at their disposal, so some of their equipment will be at their disposal in case of need. They have everything from super computers to smaller equipment and are well equipped for the services they already offer through institutions.*

*- TT model is based on direct financing. Here and there they would get a loan from the World Bank and then they would have their expenses covered for 2-4 years and there some competences were developed and people got some knowledge and left, so they quickly became aware of the unsustainability of that and then they went to build a different System; on the one hand, a science and technology park that has a wide range of services that it offers not only to scientists and students but also to others (all acceleration activities), and at the university they started to build a system of valorization of knowledge that is much broader (technology, processes, services, all that where the knowledge that exists at the university can generate some added value - impact - both economically and socially, and in all other ways). It is a demanding process, but more sustainable and useful. Everything digital has been put in focus and through equipping the campus they have decided on a Bura super computer - it is a pledge*

*of cooperation with other EDIHs in the Republic of Croatia and beyond. They are the only ones in the Republic of Croatia to have a model of scientific development centers - centers that unite functionally (not in working relationships) all people from different components who have a common denominator in something they deal with - a center for artificial intelligence and cyber security. There are 10% of all our scientists (approx. 80 people) with knowledge of computer algorithms (informatics), ethical aspects, legal, linguistic...everything related and rely on AI - a huge added value is created that individuals do not could have. They concluded that they have all the elements, they included regional processes, they recognize that Adriatic Croatia and the Republic of Croatia should take a step forward.*

*-EDIH is an excellent instrument, they recognized the potential very early on and then they just rounded off those elements that were largely default and made fine tuning.*

*-What is your Value and Value Proposition?*

*It's not TT. They act as a consulting organization that helps someone apply a certain technology that has already been developed. The IPR that would be developed in the case of a service is an IPR from the user - they are indirectly paid by the user because the EC paid for him (a kind of cession). They are paid by the user in a complicated way in order to provide him with a certain value, which is advice on how to apply certain technologies in his business or test certain technologies for the development of a digital product or service. Either they help to develop the EDT for some digital innovation or to test the digitization of a part of a process. The next step is to know where the potential suppliers are or where we can look for them, we know what we need to know, then we can call for public procurement to start implementing that technology. That is the role of DIH. Our task is not to develop technologies and hand them over to someone else, but to help existing technologies be applied. It means consulting services for the application of digital technology, not technology transfer, but consulting and education (training, raising competences, consulting for application). The delivery of value is somehow given to them and they must respect it. Given that they have commercial institutions, they must be careful not to reveal something that is their IPR or if they already reveal that they know they have some fences. No TT from their side to users.*

*It's hard to say, I would say there is TT, but that's not the focus. They use all their abilities, transfer values in any form.*

*If we look at technology as a recipe for "how to apply something" and then it is returned through a licensed product ... we only support them to start on that path and to go a step further than they have been so far. Their benefit is the hope that the economy in the region will be significantly better after their EDIH does its job - they do not have a specific hard value that can be recognized in that way.*

*-The value will be in the strategic partnerships they build with important companies and users, but also public institutions (CBCs, community centers, public administration - if they make even a small step forward, the social impact is very big).*

*-They are a kind of organization that provides services to raise digital readiness/maturity.*

*-Who are your primary clients?*

*-That's the default. They are also mid-caps. There are EDIHs that specialize in public institutions, they are not, but they have opened the door for publicly owned institutions entering their verticals (from their industries) to use their services as well. They cannot be natural persons users, but all real public and private persons in verticals that are widely spread... 10-20% should be outside the Republic of Croatia (EC suggestion that 20% of in-bound local users assess that they do not have ideal competences and forward them to other EDIHs and vice versa, and then these users will fit into their indicators - EC does not differentiate between regional, national and European EDIHs).*

*-What are your specific activities?*

*All was given; the degree of freedom was minimal - training for the test before invest, for raising digital skills and education, support activities related to digitization (digital maturity assessment, for the development of the innovation ecosystem and for support in financing and networking of financial institutions, as well as reducing barriers). The activities and work of EDIH are prescribed by the EC (work packages, activities, outputs). They were free to define how they would implement it. In theory, they could be a consortium of one partner.*

*-Are all your partners in the Republic of Croatia? Business networks, communities of interest?*

*Everyone from the Republic of Croatia*

*Consortium partners, part of the EUIE alliance and are trying to achieve more specific cooperation with EDIHs (Madrid, Cyprus, Slovenia, Italy) - they carefully choose to make the synergistic effects as large as possible, and to develop strategic partnerships through the concept of EDIH. EUIE is very important to them - they should send some kind of joint university.*

*Every company that approaches us will receive a service from us or any EDIH from our network. They have to find an EDIH that will find them an adequate service. They are the hub that needs to ensure that every business gets service either to them or through them. In this way, EDIH develops targeted and focused cooperation. They have a database and are starting in-depth analyzes of who has what and what they offer, and this will be built long-term, continuously and without stopping.*

*The EDIH network is a copy of the European entrepreneurial network and the logic is the same, with the fact that the European entrepreneurial network had the main task of establishing cross-border cooperation, and here the main purpose is to support digitalization. EDIHs have not yet formally started functioning, but every major event involves matchmaking/mingling/getting to know each other. The EDIH network is supported by the Digital Transformation Accelerator (DTA), which is a consortium selected in a public tender by the EC, which should start working on the 12th of May 2022 and should enable all EDIH-like joint procedures, define certain maturity assessment standards, define some elements. DTA is the infrastructure that EC provides to everyone.*

*-If DIHs are non-profit one stop shops, how does that work for you?*

*All activities of EDIH must be free, which is challenging for commercial firms (change of perspective), while their services do not have to be free for end users. Some countries have solved the 50% that is the national component differently (50% is from the EC) - they will ask their clients to pay something.*

*Their assessment is that it would not work if they asked to pay 50%.*

*-What would help you in the Republic of Croatia to promote the DIH story?*

*The role of the state is to call for competitive tenders and to wisely finance (entire support projects). It would not make sense for the DIH network to do the same as the EDIH network,*

*because they will have a problem with indicators - it is important that the state properly finances their part and the DIH network that it needs, so that the EDIH pipeline is well filled. It will be a problem to deliver the indicators - the Republic of Croatia has four EDIH and no matter how little we promised, we promised much more than the capacity of our industry for digital transformation. The role of DIHs would be to give a push.*

*They should catalyze some processes that are already evident. The IT sector is growing, we have 550 local self-government units that are dead capital that can be more at the service of citizens, a huge public sector that requires support to rise to a higher level of digital readiness. No one restricts us from limiting ourselves to the Croatian market and creating economic and social value for our citizens. MINGO - admin procedures - support that, industry in step with them. Complete openness, but also awareness that our market in the Republic of Croatia is limited.*

## **10.**

*-the idea is to establish a living lab - they want to include test/validation fields in their DIH (port authorities, marinas, aquaculture, etc. and they are doing it, they wanted to sign a contract with the Ministry of Defense because a significant part of marine technologies is based on safety, and under the sea is not we can detect threats)*

*-as DIH they are still in the status of pre-existing, it should soon become a legal entity*

*-the association model, there must be cooperation between the public and private sectors (private-public), ensures transparency and trust*

*-HGK is the leader of the DIH and EDIH story, DIH cannot be a single institution (owner of one institution) and many have a problem with understanding that, and we are doing the wrong thing where everyone has their own DIH - DIH is not its own, it is mission oriented and goal oriented, they must, like the clusters, create higher-level strategic goals and ensure contribution to stakeholders within the DIH ecosystem (and in the Republic of Croatia we always approach from the position of private interest)*

*-with FER, the co-organizer of EDIH CROBOHUB++ and the initiators of the first DIH in the Republic of Croatia, InnovaMare, which will be founded by the 5 largest institutions in the Republic of Croatia (IRB, HKG, University of Dubrovnik, University of Rijeka, University of Zadar?)*

*- previously led the project to establish a national innovation system, which would have all the bodies that would monitor what happens with certain obstacles, and especially through the industrial strategy and the strategy of smart specialization - the system was established. At the level of the Republic of Croatia, there is an innovation council for industry, at the top of which are all ministers and the prime minister, then it descends to three levels i.e., parts (industry, human capacities and science). The Innovation Council for Industry has formed, and HGK is the secretariat, the thematic innovation councils (there are 5 of them, because they are all created in the area of the smart specialization strategy, of which there are 5) and in them there are over 500 stakeholders, members of these councils from science, the public sector and the private sector and should have discussed tenders in accordance with the strategy of smart specialization, to say what they need and to suggest to the decision-makers how to strengthen cooperation between the private and public, i.e. the research sector, and to revise documents, etc. In MING, there was a change of state secretary and they hope that it will be activated again, a job that worked great and then what. The new Secretary of State could initiate it. Everything exists, it just doesn't work operationally.*

*-There is no progress if the motivator is based on funding from EU funds and public scientific research incentives, there must be a long-term interest in every initiative.*

*- Cluster development strategies are the same as for DIHs.*

*-HGK or HUP (some such institution) must be the driving force because it can function in the long term in terms of the support and resources they have*

*-they hold workshops for new project proposals (universities, private companies, public administration, local self-government...)*

*-strategic project, received money (interim project, a legal entity must be created that will continue to push the story - 14 institutions from the Republic of Croatia and Italy - all of them*

*will be stakeholders in HUB and all must invest funds in DIH, and not just wait funds from the EC)*

*-their DIH is focused on two areas: marine technologies (all technologies related to the sea) and sustainability (the sustainability of the Adriatic Sea is created by those who use the sea as a resource, which are the sectors of the blue economy) - we need to change the activities that are carried out on the blue sector to make it more sustainable than the resource (Adriatic Sea) that is being used. How? With technologies. They are working on technologies around the ecosystem that will change the blue economy to be sustainable in the system in which we live. DIH (a purpose-centered innovation ecosystem) must be visionally clearly defined. Purpose (strategic goal): sustainability of the Adriatic Sea. In order for a purpose to exist, there must be an enabling environment, market system context, cultural-institutional context and regulatory context (which pushes new technologies), financial resources, natural environment and two things in which we as the Republic of Croatia are the worst - social and human capital (according to the global index of innovation, the Republic of Croatia is in 118th out of 124th place as social capital (networks) - DIHs, cooperatives, clusters, and in human capital we are even worse)*

*- blue economy sectors are 25-35% of GDP*

*- monitoring of oily water, black tanks, footprint of yachts at sea - monitoring technology - AI, sensors*

*-it is a cross-border DIH and connects the economies of the Republic of Croatia and Italy (domestic and foreign companies)*

*-KPIs - there will be some, adapted some already existing and developed (from some cluster and will complement it with the technological aspect), they are not about that yet (project management deals with the action plan and KPIs - they will hire a project manager, from deals with strategic guiding)*

*-services of their DIH: test before invest, InnovaMare academy in Šibenik (they want to combine technology and biology), support to find investment, matchmaking and networking, transfer of information, finding solution for a challenge*

*-additional services are: project management, involvement of society/raising awareness, creation of a database of information and views on the future so that decision makers can make better decisions for the future, business model development for SMEs (they help companies find a market) and data service (that's more secret)*

*-also cover the public sector (decision makers)*

*-billing model: sometimes membership fee, and sometimes billing for services (depending on who the client is)*

*-the public sector in the Republic of Croatia lacks motivation, and the way of management is interrupted depending on who is in power/position - there is no strategic reflection and agreement on strategic goals, those who expected the state to stand behind them have failed*

## **11.**

*-Activities: digital support to businesses, scaling other people's knowledge on digital possibilities and how they do things, strengthening SME capacity to engage in industry, now considering the industry which would be interesting (Healthcare...), went to Aalto to get more info in an attempt to become a DIH.*

*-Don't have a socialization yet (environmental issues are also being considered, hosted events in those areas)*

*-How will you finance it?*

*Not a part of official network, supported by university (financially and equipment, and there will be a commercial element to it). There is a membership fee model but people don't pay for it at the moment because of the European regional innovation fund is changing in March, so they have to change that. They will have to pay for specific services or they could have training event, different events, at the moment not everything is being charged, but they are changing that model at the moment.*

*-Who are your customers?*



*SMEs, there was a rule under European Development Fund that you had to be a business, so you could be an individual business but as long as you are a business. They have to be commercial business and have a tax number. That could also change.*

*-Collaborations/business networks/communities of interest?*

*Urban manufacturing (production spaces etc. but some of them had digital elements to them). They want to keep the Espoo network-will keep the bilateral connections even though they cannot officially be a part of the network. Espoo can be their proxy (would like to be involved in meetings, conferences, networking, know they can't get the funds).*

*-How do you rate efficiency?*

*They have the outputs that they need to report, but that will change.*

*-What are your stakeholders, who is in your ecosystem?*

*Steam house, regional innovation agency and council, well connected to innovation center in Birmingham, local universities, through projects to some other cities and towns in Europe. Council falls under public administration*

*-Came to meetings in Ziccer (Zagreb).*

*-What are your Values and Value Propositions?*

*Does not know, still in development phase, they might have been agreed upon, but not widely known yet.*

*-What are your resources?*

*At the minute they have a room, have some finances for equipment of that room, have a technician with equipment, a project manager which normally works with European projects with networking connections.*

*Networking would be a value they offer,*

*-They are innovation center heading towards a DIH concept?*

*Yes, they have a production space, biomaterial labs- those are all resources+ 3D printing lab.*

*-Do you cooperate with other innovation centers (if can't help a customer, do you forward them forward)?*

*Yes, in Birmingham they have a prototyping center which focuses on manufacturing, so they would forward a customer to them. Also, biomaterials lab, SO far working only with UK partners, Interreg is the only outside of UK partner.*

*-Are you aligned with S3 strategies?*

*Does not know. They have them, but is not sure about the alignment with them, they don't bother themselves too much with them.*

*-These were the ERDF outputs which we reported on (until March 2023) but going forward there will be a commercial model.*

*C1 Number of Enterprises receiving Support (12 hrs)*

*C2 Number of Enterprises receiving grants*

*C5 Number of New enterprises supported*

*C8 Employment Increase in Supported Enterprises*

*C26 Number of Enterprises cooperating with research entities*

*C28 Number of enterprises supported to introduce New to the Market Products*

*C29 Number of enterprises supported to introduce new to the firm products/processes*

*Grants 33 in total for £2,500 each to support prototyping*

**12.**

*-They are EDIH*

*-Activities?*

*Public activities: trainings -reskilling and upskilling of the employees from the industry, events (mostly workshops focusing on access to finance giving all the possibilities to SMEs (grants, voucher, loans)), raising awareness about digitalization possibilities of the industry, bootcamps for high school and university students, workshops on what is on the market and what is available to the companies. In EDIH, half of that is covered by EC, and the second half is from the Slovak government, so it is for free for the participants. Funding is just to cover the expenses. SMEs are for free, and maybe midcaps too, and large companies should pay for it, but they are still not sure how to do it because they are not supposed to make profit. 90% of the participants get it for free.*

*-Collaborations, business networks, communities of interest?*

*One partner from consortium is industry cluster, so they are naturally a part of the environment they already created. In the nearest future they want to spread the information through any channel to create the environment- some kind of environment they already have, they are connected and just want to make it bigger and bigger. Those connections are mostly in the country but still have connections in central Europe (CZE, AUT, POL, HUN)- those will be partners for closer collaboration. Already have some meetings and preparing some meetings on regional level for next year. They are looking for EDIHs from other countries, and other universities mostly the cluster organizations (mostly companies, research organizations, government organizations) and European Institute of Innovation & Technology (EIT).*

*-Are you doing anything with public administration?*

*Also, a part of their services is providing for regional governments, municipalities (starting the first negotiations with Bratislava city council), also regional governments. On the state level it is not their topic and it is really a long term.*

*-Who are your customers?*

*80% are SMEs, entrepreneurs, it should be up to 500 employee companies, but most of them will be 20-50 employee companies, producers (manufacturing), industrial producers, and 10% is midcaps (bigger companies), and regional governments.*

*-Did you start as a DIH and became an EDIH?*

*They are a public organization or the government agency and we are connected in many other like Interreg, Erasmus, other grants and projects around Europe. In some of them they are just a part of consortium, and in few of them they are the lead partner. They prepare a project for a call. They were not a DIH before, but have some connections with local DIHs (have connections with local foundations, have some kind of expectations and then they applied for a call from EC.*

*-Who is all in your ecosystem (stakeholders)?*

*Ministry of Economy, Ministry of Investments, Regional Development and Informatization of the Slovak Republic, government office responsible for the digitalization- so all the relevant players on ministry/government level, implementing agencies, Slovak innovation and energy agency, agency for education and higher education and research and development. Then (big organizations): industry forum which is some kind of cluster organization on top level, relevant SMEs, media, high schools, universities, all the relevant R&D players in Slovakia. They are working on a national level- the agency is very connected with industry and can create bigger system.*

*-Is your work aligned with S3 strategy?*

*Yes, they built a project on it. Right now, S3 strategy is updated, and they are one of the co-creators.*

*-What are your Values/Value Propositions?*

*Networking, not TT, KT yes, best practice, access to testing (can open all the industrial test beds) and education, training, access to finance.*

*-What are your resources?*

*Infrastructure for partners form consortium- one of them is owner of one of two Slovak test beds, the other is robotic center (it is on university level), all kinds of expertise (experts from the government level (policy makers), for business (two partner in consortium are big industrial and IT companies), networking (cluster industry forum), financial resources (as an agency they are supported by the government).*

*-Do you have KPIs?*

*They first they set up KPIs in the project and the EC confirmed them, so they have very exact KPIs (how many services were used for the SMEs, how many participants on the training...one of the crucial is progress on digital maturity assessment-with all the companies you are connected you have to start digital maturity assessment and then you have to do it one year after providing the service and then the two years after- you can measure the progress in digitalization, the some internal KPIs (demand of the companies in digital tools after few years), number of participants (companies), different services (in two years it can change because of different services, growth of the economy).*

*-You are an EDIH now but not a DIH before. Are DIHs predecessors of EDIHs or are EDIHs special kinds of DIHs?*

*In Slovakia, DIHs before were a very beginning of something that had an international dimension, not so much internal. They had had two DIHs on universities, part of the regular university projects without much impact, resources, and people involved. It was testing for EDIHs. Now they have experience with something like this on Slovak level, have some kind of arguments. According to DIHs they just built bigger projects and spent more money on this kind of projects.*

*-His EDIH is responsible for industry 4.0 in Slovakia. You have a lot of money and also a lot of responsibility, it is a prestige of the agency to be the lead partner of the EDIH. In Slovakia right now, there are 4 EDIHs with the contract with EU and one extra which is fully paid by the government (the same system)- it was the contract between the ministry and EC- they will support 4 EDIHs and if you have money, you can have more. Each country can choose which package for the money they will use- some of them pay it by the government and some try to find it on European level. Slovak Government decided they will pay from Recovery and Resilience Plan, so it is again European money just from different stream. So, four EDIHs – 50% money from EC, and 50% from the government, and one EDIH is fully paid from Recovery and Resilience Plan. In Slovakia there is one DIH which transformed in EDIH/lead partner of EDIH (from technical university of Košice).*

### 13.

*At the beginning of DIH story, analysis was conducted which showed that majority of funding goes to big companies. After the first big data hackathon which Eurostat organized, and after that in 2017. there was a data challenge- post festum analysis was conducted. It showed that Europe is lagging behind in digital services compared to China and USA, and that propagation of money which EU sends to end users is bad. And then someone performed a study which said that we should try to create DIH network with 500 DIHs in Europe (they have to be knowledge disseminators, companies which will prove that they connect experts and companies) and the idea was to get some kind of DIH label, and that Europe has a way of financing them (Erasmus Horizon calls- some companies did not know how to apply, and some which were not a part of a bigger group could not apply). Algebra together with FER was the first functional DIH in RH on S3 platform. Europe at some point realized that too many entities of different kinds (some functional and some not) were registering on S3 platform, going far beyond the number of 500). Those institutions through some kind of a label were supposed to be eligible for funding, but then RH at some point loosened the criteria for application so much that there were too many of them- or techno councils- all bad initiatives with no future because if they don't have a line of financing, they will last for one mandate only. DIH had the same destiny- too many entities applied on S3 platform and Europe could not say which ones were DIHs and which are not and states were too inert. In RH, there were too many registered, RH did not know how to tell others that they were not good enough, never managed to create some kind of criteria, never got the money and the money were rebalanced to something else. And then Europe did not know what to do and then invented EDIH, and in order to include states from before the process, they gave some guidelines and in EDIH call they said there should be one by NUC region (near-urban core?)- RH then had 2 NUC regions and now it has 4; 2+one AI related + and regions of special importance like Dalmatia(tourism). They gave guidelines, said how much money each EDIH will get per year, but they want the state to give in pre-selection process a green light regarding whom it will pass forward, to prevent too many applications (RH again passed too many). Two most prominent consortiums in RH are the one gathered around IRB and the other gathered around FER. Europe tried not to have EDIHs of the same orientation geographically to close to one another. And then Europe said that for every euro it gives, national economy also has to give one euro. DIH and EDIH*

*connection/genesis is just bureaucratic matter. In RH, next year we will have a problem because we will have 4-5 projects each having a mil euro, each addressing couple of hundreds to small startups, which physically don't exist, and we will all have to fight for them because we wrote that we will find them, whether they are brand new, created by students... Our idea was that once they get in, we give them mentor support, FER gives them technical support, HGK education of how to attract funding/business plans etc. Srce which came with HPC will not have a mature candidate. The same with IRB. We have huge infrastructure that no one uses and that is also a problem of EDIHs. The state ecosystem does not function in a way that more people who can understand it are created. We find it more important to put 2000-3000 people on their feet, then to show to three people how HPC is used.*

*-Activities?*

*Sandbox which starts with some kind of concierge service. We created a catalogue of services which follow a business plan, personalized plans (recognizing strength, what is crucial), and then they are sent to other partners. There is a catalogue: concierge, mentoring, finding markets, monetization, FER does digital service, robotics, use-cases creation, Srce does HPC and infrastructure (servers), HGK business education and connecting with business sector. When they sign a contract, it will be on the web page.*

*-Who all are your clients?*

*SMEs (start-ups)- one SME is one KPI, micro was not allowed, and public institutions are a client.*

*-Do you have collaboration?*

*More than 200 in RH and out of state, with similar institutions (companies like Rimac, other EDIHs, academic institutions...).*

*-Financing?*

*We will perform service from the catalogue and EU will pay. We are a private education institution, without state subvention, and how can we function without a profit? The biggest problem is finding persons who want more than web design then not being able to provide the right service.*

*- Value and Value Proposition?*

*They are applied, came out of applied university, when they do science they firstly make a project which someone is willing to pay for and then make a scientific article- a flip approach. We do more industrial research, have many mentors with rich business experience, can do a quick triage to see if market can be created for the idea, can provide infrastructure (but that is not so important because they are service oriented). Knowledge (one-to-one service with experts adjusted to their needs). They are missing people for Horizon.*

*-Who are your stakeholders?*

*HGK, Srce, InfoDom, ICENT, HUP (on paper, according to needs)*

*-communication between partners where all of them have different services, how will someone find them, personalized plan- structuring. Networking and personalized approach are very important. AI to go through the catalogue*

*-Quantum?*

*For whom? For which services in RH could it be used?*

#### **14.**

*-World Bank- PERs document, screening of innovation system saying how integrated they are. RH is not integrated*

*-We don't have something through which entities trough work also learn, and DIHs have that. There is law regarding entrepreneurship support and DIHs are placed there, based on which DIHs should be in register of business support infrastructure (legal entities), and most of them are not and maybe it would not be wisest if they were. So, in search for the solution, since we said we would finance DIHs through the next OPKK (Operational Programme Competitiveness and Cohesion), in order not to create admin burden, we said let's make a project regulation for them through calls. We still don't know what to do. Trough National Recovery and Resilience Plan, one of the reforms is the creation of national DIH framework.*

*-We chose EDIHs through public call, the ones which fit into the story we wanted.*



*-Our EDIHs really will lean toward S3 strategy and towards specializations; they will have more possibilities than DIHs but will be more specialized in a certain area- not sure yet how to do it.*

*-Out of DIHs so far on s3 platform; many of them don't even know what it is, called themselves DIHs, it's something they used to do before and not core business, registered on S3 platform because they saw a possibility of being financed, some have no legal status, some use infrastructure through university, many said they needed to be regulated and connected, that they need profiling and branding+ networking with other DIHs/EDIHs etc.*

*-Sustav poslovnih informacija (SPI) made innovation web platform (<https://inovacijskaplatforna.hr/>) - has no use because no one is filling it in, since there is no capacity for that. It will be suggested that this infrastructure should be extended towards DIHs and EDIHs.*

*-SETCEL- should have been called "Mother of all DIHs" – should be an institution with public authorities, platform which unites it all, and should be there as a one-stop-shop (the building has the capacity for all needed).*

*-Public call for EDIHs was created in 2020 through MINGOR (for national EDIH candidates which would be able to apply for EC programs). We created evaluation framework for those applications (do they have a good networking with the members of their consortium; sectoral focus- HPC, cyber sec, AI; to decide if they are regional or national level (locality of their work); which technology they use- based on that they were chosen (5 candidates), we helped them fill in paperwork, find (co)financing through national framework for Recovery and Resilience (component: green and digital economy)- we ensured them 3 years through MPO (National Recovery and Resilience Plan) and the next call will provide extension for 4 more years through financial framework. We had consultations regarding how the financing will be done because it is synergistic financing (because the financing is not purely national but also through a European fund InvestEU). We still have problems with state support. DG COMPET (important for state support) gave 3 articles and de minimis. Ministry of Finance has to approve national programs for EDIHs, and they don't really understand the concept of EDIHs.*

*-So far, EDIHs have 50% support form EC, and the other 50% is the target in national recovery plan. There is a plan to establish minimally 3 EDIHs in Croatia and if not, tranche for RH does not go forward towards MPO. So, we have to do it. MPO is simpler, and OPKK (Operativni program konkurentnost i kohezija), European Structural and Investment Funds (ESI Funds) are more complicated.*

*-DIH financing- recently created operational program for competitiveness and cohesion-financing till 2029, but we don't know yet who to finance (we have to do analysis what DIHs need, best practices of other states- World Bank was supposed to do that).*

*-There is no more money in MPO for financing the fifth EDIH which did not gain EC support and received Ciel of Excellence. It could be financed through structural funds maybe.*

## **15.**

*-Activities:*

*1. test before invest*

*2. need assessment and maturity understanding*

*3. support to finding investments (connecting customers with existing investment network), increasing knowledge of customers of available investors, only assisting them like support for writing application for outside funding (for the rest there are consultants)*

*4.networking and ecosystem activities (events, workshops), connecting customers*

*-orientation of the DIH- coordinating processes for the city, but the main efforts are on digital service industry, smart cities, healthcare applications and solutions*

*-EDIH*

*-Public admin projects- thinking about it (focusing more on digital service)*

*-Work aligned with s3 strategies? Yes*

*-Funding: 50% European Union, other companies 10% (private companies which already agreed to partner up= partners, annual fee and then they have some special rights meaning*

*some services for free), 30% Ministry of economic and Employment of Finland, the remaining sum is covered by City of Helsinki Innovation Fund*

*-Customers? Mostly SMEs, happy to work with any company regardless of size*

*-Values/Value Propositions? Increasing digital maturity of companies (to deliver impact on the companies), TT, KT*

*-Investing in network activities*

*-In AI, there are many companies who are tech savvy and many citizens who are fairly using solutions in daily lives, 10-15% smaller companies use it and 1/3 of bigger ones, lot of traditional industry companies which are not using digital tech, the gap between companies which are using AI and those who are not is widening from one year to another (helping them bridge the gap)*

*-Marginal communities and elderly in Finland are one major issue (also in Helsinki)*

*-Quantum impact on DIH? More on University side, quantum is not to become relevant within the next couple of years, EDIH focus is on what is available now and how can that be used*

*-Resources: municipalities and within those many complementary resources, existing communication channels, different HUBs with their ecosystems, University of Helsinki, Aalto University, Metropolia Applied sciences...we have high end research combined in close relations with businesses in region to help with functions of our core business. Our operational backbone of our infrastructure is very strong (strong back office). University lab facilities...*

*-In the ecosystem, besides the already mentioned entities are also associated partners (lot of bigger companies with existing value chains) + Helsinki University Hospital...*

*-Collaborations out of Finland? Yes, planning to do it with other EDIHs (mainly those who can bring value to them), Functional for two months now*

## **16.**

*-Cluster type organization (association with membership structure, operational for 15 years, members mostly tech companies, research organizations, universities, municipalities, mostly*

*tech companies), 5-7 years ago designing new visions and strategies- decided to work in 2 main directions: support export companies (national objective) and digital transformation for other industries (digitalization direction work). DIHs were initiative that corresponded their values and what they were doing already, that they decided to pursue it. So, they got DIH title. For EDIH they gathered around a small consortium of partners (other organizations but they are coordinators).*

*-50%EC, remaining 50% covered by separate Latvian project (national support project for EDIHs with separate regulation- Resilience and recovery fund RRF). Fully covered, but the devil is in detail- RRFs don't cover VAT costs (value added tax- when they are purchasing goods or services, they can recover full cost from Europe but only partly from national part- for salaries and travel there is no VAT and they are covered. So, they will have double accounting one for EC and other for the state), while Digital Europe and EDIH program VAT is applicable.*

*-DIH is just a title, like ceil of excellence, so anyone can become a DIH if they want, and there are few requirements if you want this status. You have to prove that you are provide digitalization services and that's it. It is based on what kind of services you provide to SMEs and name them (in context of digitalization). EDIHs have a bigger mandate coming from EC and member states and usually they are composition of partners (various partner are combining their efforts).*

*-Focusing on digital transformation- working with companies and SMEs and focusing on how to digitalize their processes. AI (Cyber and HPC not) is in their focus. Their focus is on manufacturing industries.*

*-Resources: wide partnerships which can provide literally anything*

*-Values and value proposition: digital transformation*

*-Aligned with S3 strategies- absolutely completely (finalizing document s3 strategy for ecosystem development for ICT industry- working group, she is chairman)*

*-Customers: SMEs, public administration if it fits their focus (digitally transforming internal processes, working less with new innovating platforms which is more applicable with public admin)*

*-Did not measure efficiency yet, strict policy on how to reach small companies and work with big ones (try to make automatic approach to SMEs and not waste time of consultants)*

*-KPIs in terms of reachable results not efficiency (as clusters stakeholders were tech companies, so number of services given to tech companies, how satisfied they are with their services), as EDIH will have different objective (customers have to be other SMEs the IT companies)- don't have them yet, EDIHs never happened in Europe Yet- no good case studies, no learning points*

*-Collaborations-with other EDIHs in Baltic region (intentionally and purposefully developing, face-to-face meetings, projects together, discussing further cooperation opportunities, and with some they are in contact for a long time- static collaborations)*

*-Activities: workshops, seminars, webinars, used to have TV talk show about digitalization (finished one season, discussing whether to continue), hackathons, productivity workshops, expert widgets to companies, different entities which can be interface to reach SMEs*

*-Quantum-not big impact on them, working with simpler objectives, not in the picture yet, as EDIH they are not supporting big science (this is objective for other programs)*

*-In process of signing grant agreement, all the things done so far have been done on their own expenses and risking with their own money, so not working on full capacity yet- what will real role be of DTA be (so far we haven't heard a lot from them, will they fulfil their own mandate because so far they are not, there are many things they are dependent on them like digital maturity assessment tool- DMA Tool- not ready yet, should be launched at the beginning of January- no one is saying anything, don't know methodology of DMA tool- disappointing, at this stage they should be communicating EDIHs in a more intense way- it is quite a show stopper- at the end of the day, it is a question of trust and knowing each other).*

*-Start day 1 Sept- have been working for 3 months and mandate is 3 years- spent quite a bit of mandate already- losing time because of this (EDIHs were allowed to indicate a starting date for them- many chose 1 January), from cash flow perspective they are still working on their own expense (no move from EC yet, in January they will sort out national co-financing, and it will be good enough)*

17.

*-Director of DIH Slovenia, consortium partner in EDIH*

*-Dealing with digitalization, one-stop-shop, offering vouchers and services for digitalization, have catalogue of experts, facilitating processes for funds, not specializing themselves even though they are working in different fields*

*-Consortium of 7 DIHs (it was Digital Europe Project Tender, and they as consortium applied for a project)*

*-Voucher system- 3-4 years old system of digital vouchers, small state aid scheme up to 10 000 EUR per SME only (4 digital vouchers: one is for digital marketing, one for cyber security, one for digital competences and one for digital strategy)- now in the process of renovating those vouchers because in 2 years many things changed on digital market. At the beginning, there was not much demand for those vouchers, but now yes. Ministry of Economic Development and Technology opens perspective strings- in each stream there is money and each month a particular voucher opens. They think it should be open all the time not only every couple of months- people are waiting and a voucher gets taken in an hour and a half.*

*-For digital marketing they do mobile applications, website, reservation of platforms, main services are there- financed up to 60%, first they have to choose SME, expert who will do the service for them, they get approved the project, do activities they have to do, SME pays to expert who did it, and then they demand 60% of payment through the voucher*

*In Oct started to work, applied in first trench for EDIHs under tender of Digital Europe program published in March 2022, and the ones who got ceil of excellence applied for the trench which is now open until 23? Jan 2023.*

*-Services are not free of charge- we give clients possibilities to get digitalized but we charge for each service. SMBs (SMEs are clients, public admin also)*

*-Hackathons, meetups, conferences, services through online platform*

*-Collaboration with other EDIH in Slovenia and others abroad to prepare international corridors (Slovenia has 2 EDIHs). If they needed lab in Germany, they would go through EDIH there*

*-Value, value proposition- TT, KT, regional growth*

*-When you do service list, it is much easier to set your own KPIs, EC had softer version of measuring and were ok with their own KPIs*

*-Aligned with S3 strategy*

*-They have their own DMA tool, made cca 2000 assessments mostly of SMEs but also larger companies (their tool is deeper, ECs is more basic but they will use it because they want to show the starting position of SME and later, making digital strategy showing strengths and weaknesses and will continue to use that tool).*

*-They are all (DIHs) part of something bigger (Chamber of commerce, institutes...)- test before invest, places for meetings, experts...*

*-How do people know about you: Kick off conference, communication strategy, will go in media very loudly with PR, working on the web page*

*-In Slovenia, is there enough political will to make DIHs visible? So-so*

*-Quantum-new technologies must be presented to companies, located for test before invest, arranged that companies can come and try- it's the catalogue is really important- it applies to all new services. For some new services, SMEs don't see the use for them. Are companies mature enough for HPC assessment- awareness raising to be seen if it is useful for them to be used. HPC is underused. Amazon came and said HPCs are underused and elsewhere there is a huge demand (it was a side debate, does not know the details).*

*-Knowledge database, tools offered to customers, problem with their DIHs is that customers used to getting everything for free and now they have problems with companies having to pay 8for vouchers they still get 60% but for EDIH they need to charge some money). It is clear which services are provided by DIH and which by EDIH.*

**18.**

*-Representing two universities*

*-Intelligence, planning process which involves consultation and which services they can offer to help the company, customized education with professors, many test beds (different kinds of test environments) and assistance for using them, industrial workspace*

*-Don't provide direct financial assistance, but assist them through events when companies are trying to impress investors (venture capital investment)*

*-Finding researchers, finding people who would like to work for them (graduating students, PhD students), matching through organizations*

*-Don't want to offer legal advice*

*-Has focus areas, invite companies which they would actively try to search for (smart cities, health, digital services growth)*

*-50% of funding through EC, 20% coming from partners in different ways and associate partners (price per year to be in program), 30% from government*

*-Customers: SMEs, municipalities (public administration- they do help them, but they are not the focus)*

*-Value/value proposition: trying to catalyze digital transformation of companies*

*-Measuring efficiency: work packages for different customers- will develop some kind of metrics from them, some KPIs from EC they do use (digital maturity index)*

*-Aligned with s3 strategy completely*

*-Trying to optimize something from business perspective- trying to help from a wider value perspective*

*-Collaborations: EDIHs in other countries*

*-Started working at the beginning of October 2023*

*-1 EDIH, consortium of 10 organizations (3 cities, 4 universities, ERT digital entity...)- none of those entities was a DIH before*

*-Resources: testbeds (can use them but are not theirs), all the partners have and that they can use*



*-Quantum- was mentioned but not considered key for the EDIH*

*-Interested in the thesis results and use*

*-Classification system of some services, AI oriented- will send*

## **19.**

*-Activities:*

*5 packages: 1. coordinating, putting services in order, being the first point of contact for companies to call (service office, main coordinator is Helsinki); 2. Skills and training; 3. test before invest; 4. support to finding financial support and networking; 5. communications*

*Different training activities free for customers, advising, test before invest (testbed services depending on the customers...testbed Helsinki has smart mobility...where you can have your final product tested, they have AI, cyber sec, use of data, XR (extended reality?), digital services, smart city, health). For healthcare, there are different kinds of hospitals where you can have your product tested.*

*In test before invest they have hackathons, piloting, advisory services, at university of Helsinki and Aalto university there is possibility to do master's thesis for free for a company who needs it, cca 60 laboratory testing facilities.*

*KIRA Hub- smart building field- training and piloting for smart building companies on AI*

*Advisory service for applied science universities- very fast prototyping- Metropolia University of Applied Sciences- also has XR laboratory where you can test your product.*

*CSC- handling HPC (fastest in Europe)- HPC consultancy for the companies*

*Many test-before-invest activities, now have services available*

*Looking what they can do for 5G and 6G in Espoo*

*Funding for the companies- while they are doing test before invest they are sending companies to other services, but more traditional support to finding funding*

## *Networking*

*Communication is also important*

*9 big organizations are in test-before-invest under different themes, so they can service the companies together- first you have to understand the services of others*

*-Financing (cca)*

*40% EC, Business Finland funding from the ministry of Economics 30%, 30% coming from associate partners paying fees (big companies, hospitals), 10% own money (Helsinki also helping with the innovation fund)*

*-2 or 3 Oct started being active as EDIH, but started trying to find the funding years ago*

*-Before becoming EDIH (have many clusters and hubs), were not a DIH, have been collaborating with different projects with other hubs, but this is different now*

*-Collaborations: regional (southern Finland, whole Finland), smarty city innovation hub (different hubs form Finland and Europe), had innovation ecosystems based on innovation different projects, members for a member fee are welcome, there are different hubs in Finland like for sustainability (in EU and out of EU)*

*-Aligned with S3 strategies- in Finnish region it is an important factor in the first stage, now looking into who can be AI customer (ethical side and company sustainability side), first screening companies, SMEs are really in there (economically helping them)*

*-Customers: SMEs, public admin units (municipalities, hospitals), micro companies (in Espoo 95% companies are 1-2 person companies they call the SMEs even though they are micro), larger companies*

*Connecting smaller and bigger more experienced companies*

*-Value and value propositions: KT, TT, regional growth + making the next step with digitalization in Europe, most of all with AI, more traditional and smaller companies are lagging behind, not looking at ones who are not at all looking at AI, looking at ones which have some AI experience and hoping for a domino effect to get the other ones on board*

*-Measuring efficiency and metrics: just developing them, KPIs are a very complex network of elements (grow maturity of AI knowledge, transferring high levels of KPIs to work, have to categorize both customers and services), doing service design right now to get two of those together, finding an easy way to categorize customers*

*-Quantum computing and communications: absolutely the next step (data challenges more than AI challenges that the companies have), just opened computer for research, will start and look for customers who can use them, Espoo is well providing service to everybody and available to everybody, who could be using in future is the question- will start talking in the Spring to quantum ecosystem, SMEs have done little with AI but not a lot so they will not be the first ones coming for quantum*

*-How do we come to customers and guide them forward, it is about the people who work for HUBs, who in the broader area in Finland can help them, being honest that if we don't have a service, we have to send customers to other hubs who can help- working on a "we" is a must ("we" in being fair as a DIH)- not easy to put in words, wrote a handbook in English. Also, it is about seeing the services (going to test beds- the latest products and applications), easy to make HUBs virtually and saying we are doing it together, but if you have not seen the services and if we don't work as "we", it will not work- there has to be honesty, everyone has to say what they can really offer and open the test beds- have to be open about the situation and say which test beds they don't have yet.*

## **20.**

*-Activities: value deliverable services, first we need contacts to the customers through advertising and communication activities to get in touch with target groups and inform them of our services, we have customer journey, topics for them, systems of customer relationships etc., we have to plan our services, think which ones are good for SMEs, maturity analysis (2-3 hours of questions to go through to get a first impression of SMEs too see what are the topics for them and tailor workshops, they can book other courses but can go directly to innovation workshops), innovation services, consulting services, you need qualified employees and that is also very important. Smaller companies don't have systematic approach and personal*

*development and that is important (where they can find qualified staff,, look at our agency of labor in that field), have also expert networks and self-learning opportunities for them, network, exchange of experiences in this field. Marketing, communications, sensitizing companies, innovation and qualification topics...*

*-Customers: SMEs, micro companies, companies with 10 employees, large companies, 50-100 typically, but big companies don't need our services, they have their own innovation labs (can come to workshops if they want to), public administration (local cities, communities (development of regional strategies consulting)*

*-Try to get some revenues out of services, but just to cover expenses*

*-Collaborations: also, outside Germany (they are lead for Danube group for digitalization), other regions*

*-Work mainly aligned with s3 strategies (automotive and IT sectors are strong in their region)*

*-Value and Value Proposition: TT, KT, lag behind universities and SMEs and public administration- not a typical transfer- bringing knowledge from university to companies, they are more development agency and not research or innovation agency- have contact with SMEs, know regional economic processes and chance to get to regional universities and develop innovative projects, bring students together and this is their position in the region*

*-Quantum computing and communications: high level topic at the moment, have possibilities to organize visits and events for people interested in quantum computing, but at the moment it is a research topic and not practical solutions, it is interesting to think of possible solutions, and see which companies would be interested, it is a strategic topic and not practical*

*-DIHs predecessors of EDIHs? Had proposal for EDIH program, all hubs have similar services but not so deeply for business development and model development which is their specialty compared to DIHs and are experienced in this field, but all HUBs have similar approach. EDIHs could be a success model which will work in every region. There are lot of HUBs but there is no proof of what works in every region*

*-How do you measure the success of your DIH: measuring contacts, participants on trainings and events, how many consultants' talks they have, they have typical KPIs, after 6 months or*

*longer they look at the obstacles and did things really work, we can do better than just to have efforts on this topic*

*-Resources: own labs on their own location, but also university labs and from other communities in the field of AI corporations/software centers, companies, have partner structure- look at what resources they have and if they can work together*

*-Why are DIHs better or more progressive than the other structures or is it just that they are dealing with matters of digitalization? More focus on the special branch, smaller focus, there are both advantages and disadvantages, DIHs are more open to other tech/sustainability/different branches and it is better to compare, benchmark, cross sectoral innovation topics... cluster initiatives are also very useful and have more focus on their topic*

*-Main obstacles for DIHs are finding strategic position in innovation ecosystem. We have chamber of commerce which is strong in Germany, have many state topics and it was difficult to define our mission and view of innovation system. There should be a clearer focus and topics for DIHs but on the practical side...they are a new player in the region and are competitors for the others – and they have to show that they are not a competition- need time to find the right place in the ecosystem and show how valuable their work is, and that they have experience as well.*

## **21.**

*-European network layer- connectivity which is different from when you are on your own*

*-Activities: they call them services with different activities in them. The first service is skills and training (combined access to all existing knowledge, trainings, development of new ones, connectivity with organizations), then the core where digital maturity level is expected to increase and also test before invest (connect existing infrastructure and facilities like software, digital laboratories with equipment and living labs- high TRL and then you connect them with real life applications), support to find investment (connect possibilities with public and private actors), mobilizing of the ecosystem (classical activities where they connect already established events like conferences and webinars, then own organized events like*

*matchmaking which can be physical and online, industry and come and visit the labs + explanations)*

*-Now we see more and more that embedded in organizations there are mechanisms for transfer (offices of mechanisms of different projects)- embedded is important, not just the office-embedded organization which represents target industry (innovators have experience and know how to deal with innovations, to detect innovation applicable to businesses)*

*-Some companies are not capable of absorbing innovation and for them is facilitating to knowledge (softer approach). Those who want to really engage are put through test before invest (to give them opportunity with reduced price of only 20% of what they would normally pay (because they get grants)- they get top expertise, top quality of equipment, access to various data/software/capacities and discussion with experts before they engage why should they do it, what it does for them- small steps to convince companies to get the novelties). Then they are convinced that these novelties will do great things for them, but they need money and then are given hand for finding investment. All countries have to level already established projects and mechanisms (not discovering hot water). What they do is more tailor made encompassing all existing companies. They try to avoid B-to-B; in the spirit of the hub all should be given in one place.*

*-Lot of EDIH start from DIHs existing for many years already (upgrading), well connected with stakeholders*

*-EDIHs are about advanced digital technology. General digitalization of a company is not what we are talking about, this is about getting intelligence for using digital solutions, advanced capacities for handling data and advanced systems for security. Some companies need basic digitalization but EDIHs focus on true nature of advanced digitalization because in Flanders these industries already exist.*

*-Financing: 50% EC, combination of several sources within Flanders but nothing from the province of Flanders itself*

*-20% payment for some specific services; large companies pay full price because they don't receive state aid, for SMEs and Startups they pay 20%*

*-Specific target is SMEs. Large companies are big enough to do a bit on their own or pay the full price.*

*-Operational on 1 Nov 2022 as EDIH, external kick off with all mechanisms (internal processes) ready 1Fev 2023*

*-Value and Value Proposition: KT and TT, in most together both together and what it could represent for improving the business- that is the added value- how much, depends on the company (more clients, savings, byproducts, more turnover...in most cases economic value). Worked with cities and municipalities, social housing companies (digital solutions for them which can improve buildings management, decision on investing in these buildings...). Not working with public admin.*

*-Work aligned with s3, but the aim is helping the companies. They don't conflict with any strategy.*

*-Quantum: does not know, not as such in their offer. Some other EDIHs are especially stressing that in their offer, but they don't even use the word. If a company needs help with quantum, they will point them in the right direction.*

## **22.**

*-Working with policy for the government, also supporting EDIHs in Sweden*

*-EDIH financed 50% EC (don't get the money right at the beginning- 30% when signing agreement, some after 18 months, and rest in the end), ERDF (at the end of project- 40%) and regional funding (other sources) will cover the rest (10%)*

*-Services mostly for free, not sure if there will be paid services*

*-One operational on 1 Dec 2022 and three on 1 Jan 2023*

*-Work aligned with s3 strategies mostly*

*-Customers: midcaps, big industries*

*-Quantum-thoughts, but not a part of EDIH in short term, but it is mentioned in their applications. It's too early to say because it's new*

*-4 EDIHs in SWE (were well established actors/corporations in SWE innovation system, consortiums now- universities or other kind of organizations working closely with industry)*

*-Two are industry hubs, one in AI, and one in health*

*-All collaborate internationally*

*-Biggest advantage of EDIHs- long term sustainability, collaboration within Europe, can strengthen collaboration in SWE (usually working regionally and many EDIHs now working throughout bigger area)*

*-Value and value proposition: strengthening small and mid-size companies, sharing development especially in healthcare would be very beneficial (developing services)*

*-Resources of EDIHs: mix of private and semi-private university labs*

*-Metrics for efficiency: not using any other KPI of other than given, no additional KPIs (doing what DTA is doing)*

*-DIH and EDIH network working together is not in place yet, one of the main tasks is that EDIH gets established in SWE innovation system (new resources and collaborations)- will work hard on it in 2023, to make sure the benefit goes to the whole SWE*

*-EDIHs similar in structure? All different; two of them lean on universities, two more like science parks*

*-Are DIHs 100% sponsored by state or do they charge fees? They are fully financed now*

*-Will there be more EDIHs? 7 ceil of excellence entities and looking into how to find financing- have very different thematic (Agriculture, Industry in North SWE- mining to electric and hydro mining instead, AI, Cyber)- all these ceil of excellence entities could bring benefit to SWE industry and society- the main goal for them (SWE) to see they need them*

*-Biggest problems for DIHs and EDIHs in SWE? Financing, also some companies legging behind. First thing is making sure they stay competitive, for HPC there will not be broad usage*



*(only for smaller and more advanced entities). For now, all is on the paper, they need to start collaborating with companies to see what the needs are*

*-How do people find out about DIHs and EDIHs? Will use existing channels (public admin, supporting organizations for developing new companies, private organizations working with company development, each university/higher education have science park connected and that will also be the channel)- the innovation system in SWE is well connected. There is the challenge to reach the companies which have not been in contact with innovation system before.*

*-Is AI in healthcare a challenge? New tech is always a challenge, but doctors in SWE are already working with AI- it's a long-term work. The biggest challenge is the lack of doctors and nurses. People might be afraid of tech solutions in general in healthcare. Future problem needs to partly be solved with innovation. It's usually not the nurses who are not adaptive but lawyers. It's a challenge for everyone when you have a lot of change coming.*

*-Many things can be improved and EDIH can be a part of that*

## **23.**

*-EDIH, 1 Jan 2023 will be operational, their leader was a DIH before (not them)*

*-Poland has 12 EDIHs, all supported by 50% from EC, other 50% from European Funds for Modern Economy 2021-2027 (only existing EDIHs will be able to participate in that contest)*

*-Aligned with S3 strategies, each region has smart specialization*

*-Collaborations: for internal cooperation they have coordinator of EDIHs (person working for Future Industry Foundation, Ministerial agency of ministry of development and technology)- improvement of cooperation, development of guidebook for the standardization of the services given by EDIHs (relations with clients, maintenance of the clients, quality of services and standard for the quality of services- meetings held so far), for external no guidelines except writings submitted in the proposals, but during Espoo meeting were contacted by Latvian EDIH and were invited to meeting of Baltic EDIHs (workshops)*

*-Customers: mainly SMEs (feasibility studies, trainings), for EDIHs is more complicated- services also given to public admin, but there are different rules- for now have only 50% money and will not get it before April/May, maybe June/July, so they have to be careful to whom to deliver and which services in this first part of the year of the project because some costs might not qualify- now being discussed (specific description of priorities was not prescribed and monitoring committee is not appointed yet)*

*-Value and Value Proposition: KT, TT, community building services, test before invest services like digitalization pathways, testing and feasibility assessment, smart devices data technology demonstrations and advanced AI services like cyber security, design thinking, design technology solutions, test before invest, skills development services, knowledge training sessions on the job, advance training course on technology and soft skills, editing adoption, last pillar is support services (financing, funding, scouting for deployment of digital solutions and accelerating and mentoring in digital areas)=TT and KT services*

*-Focused on Industry 4.0 manufacturers*

*-Different (mostly technical) participants: Universities, 4 Institutes, Agencies, Companies; centers of Innovation, Chamber of Commerce- 10 partners focused mainly on manufacturing and digitalization*

*-Using partners' test beds and labs*

*-Quantum: already dealing with digital twins, training calls for students and workers, working on different solutions with German partners*

*-Efficiency measurements: number of people trained, improvement of digital maturity of organizations, market maturity and market potential for innovation indicator, the number of collaborations with other EDIHs and stakeholders (also on EU level), number of businesses of public sector entities, number of additional investments successfully triggered by the projects, number of persons who received the training, number of cases who integrated AI in products*

24.

*-Involved in creation of state owned DIHs, professor at university of applied sciences which has a DIH (involved in it)*

*-EDIHs are more advanced DIHs, funding opportunities are much bigger, there were HUB initiatives in different states (were not bad, started years ahead- they had experience)*

*-Digital business model development*

*-Failed in applying for EDIHs*

*-State financed 50%, 50% by themselves (own money)- government is involved in this HUB- a tool of offering digital transformation of tools and skills to SMEs in the region, so they look at it as an investment*

*-Aligned with S3 strategies in the region, their region mirrors well conditions in the state*

*-Activities: deliver services (to change business models, first survey about the condition of SME- digital health check, digitrans method, consulting SMEs and then handing them over to local software companies' cluster- 1500 software produces in small companies)*

*-Also have supply side of digitalization not only the demand side*

*-Existing structures from a long time, but DIH gives one-stop-shop in the region, to talk about digitalization, presentation from university about new technologies, best practices, entrepreneurs' breakfast (for the owner of car mechanic shops there- cca 1000 employees to 2 employees, but they all use software from car industries, share experience from everyday life, also with functional clusters like procurement managers and showed them the newest developments in procurement, every two weeks they have something in this ongoing process)*

*-A lot of marketing, awareness raising (even though they knew about them for a very long time)*

*-Educational training, lowers barriers to participate in trainings (easier later), all keen to meeting each other again, more popular than before, becomes community of interest*

*-Collaborations: strong focus on the region in their DIH, strong exchange in the state of Baden-Württemberg (one was successful in EDIH proposal, the one in black forest)*

*-District government tries to give 50% money, and also 50% Baden-Württemberg state*

*-SMEs, micro companies are the majority of customers (80-90% of the companies they consult)- have less than 15 employees, public admin are also a serious customer (online access law- all public administration should be accessible online, whatever that means, many processes had to be digitalized like videoconferencing)*

*-How do you see DIH network being interlined to EDIH network? All EDIHs in the state had DIHs before, sometimes a couple of DIHs create the same EDIH, so they are all interconnected. All created service catalogues in the region. In couple of years, there should be professional funding of DIH services, and public funding should be put in the background, so services in future should cost something.*

*-Quantum: considered, a special situation, they run 1 of 2 quantum computing in Germany and one EDIH is linked to this, but it was prefunded before by German state and IBM, nothing for the everyday life for SMEs, crypto would be the customer, automotive industry (digital twins), genome industry (corona vaccines, most Nobel Prize winners in this area, Google with Europe AI center as well as Amazon)- makes sense to have quantum computing in the region*

*-Measuring efficiency: have to report to Government measures like successfully trained SMEs, number of business model trainings, number of linked constellations between demand and supply SMEs, number of skilled people they were able to train in different digital disciplines, the number of services in total they provide to SMEs- those are the main benchmarks of the KPIs*

*-Resources: university labs and test beds, experts, professors, in Boblingen there is a strong automotive and logistics industry (that is a focus there)- fourth biggest logistics company in the world is a partner, also engineering company Mercedes spin-off company is a partner, digitalization of aftersales processes, virtualization of customer experience in car selling point of sales, aftersales services, virtualization of electric car mechanic garage, they train people in their virtual environments to get skills in repairing electric cars- members of the Hub as their district government and they are (them being research institute of the faculty of computer science of university but also outsourced (even geographically) research center- they are the physical focus of the hub, allowed them to get the money for quite good AI incubator, financed*

*100% by their district government- this is also a good part of their DIH. They have a good software part, AI incubator for AI spin-offs and start-ups, co-working spaces with different facilities, their research institutes (melting pot of DIH)- they lacked innovation institution, so they founded it with the money from the state, brought experienced experts from other regions with a lot of networks to other hubs...*

*-Advanced logistics, car mechanic of the future lab, their labs in the area of digital transformation and creativity + business models, AI express- many institutions coming together in their city (10-15km apart are all these institutions together)*

*-Value and Value Proposition: KT, TT, facilities and laboratories so a SME can come and see and feel how these things work (hard to show the benefits of digitalization if you only have the computers) but if you have virtualization opportunities, 3D printing, AI applications, labs with robotics- makes it much more feasible and understandable to SMEs, and that makes it much more understandable, should therefore not be estimated (demonstration possibilities)*

*-DIH problems: attracting and gaining much more SMEs than they have for their HUB and their work. Bavarians did much better job- different approach; when the idea of digital transformation appeared, later than them (2015 they, Bavaria 2017), invested 3bil EUR in digital transformation program in global area, had one central institute, integrated it into ministry (and since then it's not running) employees 50 professors in different disciplines, 100 IT professors, organized road trips every evening to every region/town in the out-bank to push the idea of digital transformation even to the smallest company, so it became a state task- today well running, 50% funded by the companies who have the demand and that is an interesting model*

*-You have to have service catalogue and digitalization check before they come in- the structures are similar in all DIHs, an interesting question would be the distinction between HUBs that offer a lot of different services and HUBs specialized in for example HPC because this will be totally different entities and institutions- not sure if you can fix them with one reference model*

25.

*-Organizing networking events combined with public funding to leverage available knowledge that other companies use (digital transformation knowledge for their transformation), funding to cover parts of the risks*

*-Center for digital transformation Bayern- worked there for years (topics of industry 4.0, healthcare, security, agriculture, digital transformation and humanity/social aspect- for every one of these topics 1-3 persons working on the topic, creating white papers, working together with the government)*

*-Networking events as core task (partners can learn for new tech, apply for new projects partly of fully funded from the government, to leverage digital knowledge available which companies can use for their companies) always with public funding for these events and publish calls for new projects which are funded- 2x a year there is a call for projects 1-3 years, 100 000 euro to 1 mil EUR per year and per project*

*-Value and Value Delivery: KT is the key, helping the management of traditional companies becoming aware of the necessity and analyzing how digital trans will affect their businesses*

*-Digital transformation should be considered for advertising (necessary in order to have successful internal processes), big task to sensitize and make aware managers that they have to do certain projects to manage digital transformation (it affects not only core project but the whole project), challenge was to find knowledgeable partners to go through this digital trans*

*-Working with different industries- one size fits all, automotive was a bit special, platform interacting with society worked a bit different*

*-Public talks, speakers from television were engaged to go to the events and also politicians- discussion regarding effects of digital transformation on society- how we will learn, work consume, problems which might arise, question of resilience (how stable will those systems be in case of problems- like in Ukraine (no electricity- you are in trouble)- different discussions on different aspects*

*-Quantum: at the moment the assumption is that new tech will add like AI to digital tech, quantum will open the new question- will it be under the umbrella of digital transformation,*

*or new chapter (like electrification to digitalization)- will it be a part of digital trans or a new chapter, that we don't know. It will solve special type of problems very fast and act as a service for information systems. Like with AI image recognition and AI will allow to implement image recognition. With quantum computing certain types of mathematical problems will be solved in minutes instead of years- new class of problems will be solvable with it (special use case). It should be part of the topics in this digital arena for now, and if it becomes bigger...*

*-Is your work aligned with s3 strategies? They are big step ahead then the topics they had when strategies were made (network connection, public WIFI, public internet...)- they are advised to present their offering and they did to local companies and to local universities.*

## **26.**

*-Top-down approach not working, not specialized for a certain sector, diversification was the part of strategy*

*-Applied for one EDIH in the second call, focus on blockchain- strong ecosystem in blockchain, application in different industries- decentralization, using the tools for digitalization in all aspects of economy, educating people...support to digital transportation to whichever company comes for help*

*-Customers: companies of any size (startups, micro, large, public admin...)*

*-Sandbox for new ideas and how to improve*

*-50% funding from EC, 50% from the government*

*-Services completely for free to customers*

*-Value and Value Proposition: focus is on value delivery, to increase prosperity in general by successful digital transformation, strong focus on KT, EDIH network will be established throughout Europe and that will be extremely valuable because all will participate with specific knowledge, from universities to companies and supporting companies to create real value and that is the added value. The vice versa approach will hopefully also be an outcome (that academia learns from practical problems), but we still see how it will go as a side effect.*

*-EDIH resources: depends on the project. University of Lichtenstein involved in all projects, in the core of EDIH is HR supporting most of the projects (have expert network with knowledge), purpose driven value creation, experts in different backgrounds, KT from academia, Lichtenstein does not have so many resources which are available for academic research- only one university focused on law, economy and one informatics department- working a lot with Switzerland universities- challenges for their EDIH*

*-Collaborations: one strong with Austria with one innovation hub in terms for blockchain, will continue with EDIH (blockchain related to real economy). Other collaborations not defined yet.*

*-8 years working on the awareness of importance of digitalization and innovation, all Lichtenstein companies are aware of that, not everyone is a digital native but everyone is aware that something important is happening with their everyday life- How to use digital tools so they don't get cheated- not just for highly educated or companies but everyone needs to catch up on that*

*-Quantum: very important, one of the most important drivers of future economy and society, Lichtenstein not very developed in that, who is offering those services and access for developing such capabilities, access to such infrastructure and the need for such applications will raise a lot, but for now knowledge is so far nonexistent*

*-Difficult to operate EDIH with not fixed financial income (if you don't have the money for the remaining 50% it's a problem- that's why they asked Parliament for financing, but it still has to be approved by EC. Biggest challenge is to really support the company and educate about the possibility they have which can enhance their business, explain what is digitalization. EDIH should support also those who are far away from digitalization in order not to have a split society- main challenge. If you succeed only by educating people by abstract manner, that is already a part of the deal, otherwise it is just academic work with no real force for the real companies*

*-KPIs and matrices: turnover is relevant for measuring the success of digital transformation (not profit)- that is potential for increasing technical property of the society and the whole region (embedded projects, reach out also)*



*-Don't have specific topics on digitalization, access to knowledge, ecosystem working together to enable digital transformation is important, easier to create an ecosystem in a small state but then there are size problems. EDIH should create Europe-wide digital ecosystem which should allow access and be of huge benefit to the others.*

**27.**

*EDIH since Oct 2022, before were a DIH since 2018, for EDIH 4 DIHs joined together*

*-In Saxony, there are huge electronic factories, so EDIH combines focus on urban areas, smart infrastructure (focus on start-ups), informatics and AI (research, also HPC)- strong on electronics (hardware, software, connectivity 5G, 6G), IoT, embedded AI, smart production+ start-ups (energy, smart city applications, smart mobility, EDTs (smart administration))*

*-Aligned with s3*

*-50% of funding from EC, mixed funding for other 50% (complementary funding from regional government and certain services provide income, income from services which are for organizations)*

*-Customers: SMEs (including start-ups), public authorities/companies/city administrations/utility company*

*-Value and Value Proposition: business models for start-ups (access to infrastructure), co-innovation (coming from different companies, how to have those projects from different approaches), access to city administrations (building them services according to their needs)*

*-Easy access to offers-social media/internet, different networks/places where SMEs show up- using those events to present themselves, SME competence center has access to a big range of many SMEs in regions- build own database on partners there*

*-DIH is artificial construct- needs to be explained, SMEs are expecting to get direct money, which is not the case*

*-Hackathons (how to apply AI), training sessions (for city admin)*

*-SMEs need cultural change, how to work in digital work, so they set up a program where SMEs can learn how they can work in digital world on a real project- they bring technology and also try to install spirit of how to work- it is a new digital mindset they try to present and install*

*-Look for competence with partners if they can't help a customer with something specific*

*-Have KPIs, but still learning, no special KPIs for now*

*-Collaborations with different countries mostly with neighbor states (CZE, POL, FRA), participating in national initiatives also*

*-Advantage of DIHs: next level of networking (joint or common service and common infrastructure- that is one strong benefit), more resources, more call for cooperation (before no funding, no guidelines, and now it is more structured)*

*-Problems: mix of issues (not only technology and framework)- in their region, there are many family-owned fragmented companies which are not used to cooperation (more like competition) – how to exchange information (that's why they do maturity test at the beginning) + for certain domains, there are good solution domains (like automotive) and they can do cross learning*

*-Quantum- partners are looking at it from research side, but not from practical side in short or mid-term*

## Appendix 9: Interviewee Information

### **First part of interviewing process:**

1. Programme Officer at EC, DG Connect
2. Head of Unit, Regional Development Environment and Health at Region Skåne, previously worked at EC, DG Connect
3. Professor Emeritus at University of Zagreb-FER, ICENT
4. Scientific Policy Officer in Digital Transformation EC, Joint Research Center (Seville)
5. Coordinator of operations at Digital innovation hub at University of Maribor and EDIH DIGI-SI, DIH UM

### **Second part of interviewing process:**

1. Project Manager, Center for Informatics and Computing at Ruđer Bošković Institute, IRB DIH
2. Regional Manager at BlueHealth Innovation Center - supported by Microsoft, BHIC Care, Belgium
3. Project Manager EDIH JURK & business incubator PISMO / EU funds consultant @Regional coordinator of SMC, EDIH JURK & business incubator PISMO
4. General Manager at DIH Agrifood Croatia
5. Research Associate, Division of Electronics, IRB EDIH
6. Researcher at Ruder Boskovic Institute, IRB DIH
- 7.- 9. Vice Rector for Strategic Projects UNIRI; Head of University Centre for Research and Innovation at UNIRI; CEO at STEP RI Science & Technology Park University of Rijeka, STEP RI
10. Innovation project manager, HGK
11. STEAM International Programme Manager, Birmingham City University- STEAM International, UK
12. General Project Manager EDIH EXPANDI 4.0, SIEA (Slovak Innovation and Energy Agency)
13. Venture Scientist, Algebra

14. Head of Department for Innovation Support at Ministry of Economy and Sustainable Development, MINGOR
15. Senior Specialist at Helsingin kaupunki – City of Helsinki. Member of the EIT Urban Mobility Association's management board. Vice chair to EIT UM City Club.
16. AI, Latvian IT Cluster (EDIH)
17. Director at Digital Innovation Hub Slovenia
18. AI Ecosystem Advisor, FAIR EDIH
19. Administrative Director at Kokkolan Energia Oy Finland, Espoo EDIH
20. Managing Director ZD. BB GmbH
21. Project Manager at VITO, Sustainable Energy for Buildings and Districts / Coordinator European Digital Innovation Hub - Energy in the Built Environment- EDIH-EBE
22. Senior Project Management on Digital Transformation and Strategic and Open Data, Tillväxtverket (coordinating Agency for EDIH/DIH in Sweden)
23. Doctor of Education, Senior Researcher at Sieć Badawcza Łukasiewicz - Instytut Technologii Eksploatacji Radom, Poland (EDIH)
24. Professor Herman Hollerith Research Centre, Faculty of Computer Science at Reutlingen University
25. Managing Director SAP UCC at Technical University Munich
26. Director of the Office for Financial Market Innovation and Digitization, Government of Liechtenstein
27. CEO Smart Systems Hub GmbH, Germany (Saxony)

## Appendix 10: Notes Taken During Focus Group Interviewing Process

### 1.

*-DIH ecosystem participants should be regional (most should be local or regional, collaborating in close network or ecosystem, everything else is difficult to manage, should be manageable), could participate with out of region entities, depends on the size of DIH*

*- most DIHs are regional initiatives, mainly based on activities and services which they provide (DIHs should be in the region, and EDIHs should be used to get out of the region/state)*

*-as an innovation hub, you need to be relevant, just by definition- DIH it needs to be a larger entity, and have active community around it. The ones not doing anything on daily basis should be external (depends how DIH is set up- a consultancy or non-for-profit organization)- the key to being called a DIH is that you can build this kind of ecosystem*

*-DIH does not only have DIH web page, but also different social media presence (social media is more important than the web page)*

*-EIT are organized by EC (not DG Connect), they get a lot of money to establish activities, have different domains where they want to be active, shifting towards investment in startups, building an ecosystem with money in return for them. EITs also had a framework.*

*-they collaborated with EIT Health (funding for students to organize hackathons), it is a bit of a political decision where links are to go abroad, don't have to be in EU*

*-DIH RMM is a framework for best practices- how to construct a DIH, a bit complicated to people who are not familiar with this kind of work*

*-origins of a DIH are not always the same*

*-in IT and specific domains KT/TT does often go from industry to academia (if you are IT PhD student in a specific domain like AI- interesting when you put that person together with a clinician with a real issue and the he solves it- more value when collaborating with industries then being only a researcher in academia- the product would be market ready or as close as possible to the market- all this is more important than it used to be in the past*

*-agrees with conclusions of thesis, DIH RMM design (a framework, some explaining will be needed to managers) and suggested use*

*-can be used as a guideline for building this kind of networks, finding gaps, ISO standards of how you work, KPIs and how you measure them, how to receive ceil of excellence - benchmark to get more money from the government)*

*-there are many non-tangible things in structures like DIH- difficult to make it objective (what is "to facilitate" for example)*

## 2.

*-DIHs have regional focus, but it is possible to use another DIHs perspective (if someone from the region wants to profit from this know-how). A participant has to be in the specific region, also because DIHs get money from the government. EDIHs are for out of the region*

*-depends how you define a DIH (what is internal or external)- internal are all service providing entities, and external are receivers (providers are internal and receivers are external)*

*-DIHs should be involved with innovations- it is a combination of innovation and digitalization tools, the focus is on innovation but it depends on the meaning of innovation (the purpose of innovation is to increase prosperity and wealth of community, in this case from digital transformation (just to use digital tools is not innovative)*

*-agrees with DIH RMM- encompasses all the possible versions, tells wannabe DIHs what all it has to contain*

*-no remarks regarding EIT Hubs, use of DIHs for evaluation of innovation HUBs*

*-one of the outcomes has to be innovation (not just TT/KT). EDIH is about existing companies, not startups*

## 3.

*-social channels are multipliers in raising awareness of what DIHs can offer – communication marketing strategies are very important, a well thought through communication strategy in order to be known as a point which companies can go to*

*-I wonder – have you found / an example if it is possible that a DIH can successfully function without public finance? (for example, after several years of operation, initially funded or co-funded with public fin. support, but then is fully self-sustaining..)- yes, DIHs are mostly functioning on their own- different financing models and only relying to a public funds is the wrong way to go (maybe only in the beginning), self-sustainment should be evolution of a DIH- there are limits to the public funding*

*-clients should come from different regions (that was imposed by Digital Europe Programme)*

*-with distance, language, culture and organization can become a problem, so there has to be a strong driver- why do you have to go somewhere else (you cannot find someone)- theoretically yes, but there has to be a strong driver for going out of region*

*-it's one-dimensional to think that only DIH office should be internal- if we only stay within our cocoon (RTO) it is narrowminded, we have to go broader. Company might not be able to be in the core because especially if they are large they have their own interests (products).*

*-menu in DIH catalogue is not detailed enough when it comes for example to specific technologies (some cross different things not only AI or construction- for example buildings-*

*energy domain)- predefined menu is not allowing DIHs to find themselves- it is too one size fits all- limitations can be improved, but as a general tool it does the job*

*-EIT project examples are more of a reason for funding (active only in the beginning until they get it- sometimes the project is successful, and sometimes it does not last for more than three years)*

*-perhaps EIT hubs are not the best example. A better example for DIH RMM use would be within certain KICs (Knowledge Innovation Communities) which have hubs - perhaps it's better to find parallels with them (similar mechanism in KICs and DIHs in EDIH network, but variations of what they offer to companies become larger and larger)*

*-DIH RMM could be applied to online communities (to create online communities)- some EDIHs intend to use it, as a way of connecting in order to offer knowledge, facilitate matchmaking, marketplace for demand, can be a tool for delivering knowledge in terms of online events, a place for safe and restricted communication- maybe DIH RMM could be used for organizing these kinds of online communities+ interesting to those who want to create a new DIH (there is no one model, but I can narrow it down to possible models, tailored to the context of their working), not benchmarking of already existing but setting up a new DIH/EDIH*

*-agrees with DIH RMM and conclusions*

*-KT/TT from industry to academia happens with companies who are innovators in their nature (innovation challenged by a different market need/challenge and research is helping with a little bit of fine tuning, and company is bringing market dimension- trough that collaboration, product will be more ready to be launched on the market). Big companies have their own R&D but they absorb innovators.*

*-EDIH is a DIH on steroids. Time will tell if these networks bring added value (knowing each other, connecting us), even though no one asked for this network.*

*-ecosystem (everyone) and innovation ecosystem is not the same; if a DIH is about innovation, it should relate to innovation ecosystem (it should be about innovation). Electric vehicles company does not develop charging stations and they need each other- that is innovation ecosystem. They work directly or on a distance, but need each other).*

*- it should be more about innovation and not just KT. Helping digitally illiterate company is innovation for them, but not what it is supposed to be.*

#### **4.**

*- DIHs can work with entities out of region (to find the competences)- this is why the network exists (to know who to contact if you are missing something). DIH s should primarily serve local companies and administration, that is true. DIH should not necessarily ask EDIH to go out of the region*

- Only DIH office should be internal, yes; no remarks regarding DIH RMM, social media is important for DIHs; existing DIH catalogue is not very well structured, not much detail, DIH RMM would help; DIH RMM could be used for EDIH catalogue as well

- all very theoretical- a SME does not care who are my business partners, networks, collaborations... just what a DIH can provide (Value and Value Proposition)- that is all SMEs wants to know. Yes, from the perspective of the company. But for another DIH, EDIH or company who wants collaboration it would be interesting to be able to see these other things like communities of interest a DIH is in etc.

- EIT projects can be nothing and really good, depending on people (so not necessarily to only get the money, and the money is so poor that it would not be worth it). In the end, it all depends on the people (human factor) and how much they care

- could be used for EIT catalogues as well (EIT is more for projects, they get money for projects, and DIHs are brokers who do not get money for projects, but the way they are set up is the same)

- at the beginning, it was not clear how DIHs should look like, and that should have been done a couple of years ago, to get everyone on the same page

- Not much difference between DIH and EDIH- one gets the money and the other does not- DIH is not obliged to cooperate with Europe and that is the main difference, EDIH has to – cca 20% services have to be delivered out of state and vice versa (20% of services have to from out of state). Other than that (structure and all), they are completely the same

- DIHs are supposed to be a consortia of partners with complementary expertise (university with expertise who needs someone who is politically strong, business partner, research center with a lot of capabilities- 100% of complementary expertise, so you can give 100% of everything)

- KT and TT form industry to university in technical fields- for sure



## Appendix 11: Focus Group Member Information

1. Regional Manager at BlueHealth Innovation Center - supported by Microsoft, BHIC Care, Belgium
2. Director of the Office for Financial Market Innovation and Digitization, Government of Liechtenstein
3. Project Manager at VITO, Sustainable Energy for Buildings and Districts / Coordinator European Digital Innovation Hub - Energy in the Built Environment- EDIH-EBE
4. Coordinator of operations at Digital innovation hub at University of Maribor and EDIH DIGI-SI, DIH UM

## CURRICULUM VITAE

Marina Jurčić was born on February 8<sup>th</sup> 1980 in Požega, Croatia. She graduated from The Citadel, The Military College of South Carolina in 2004, obtained MBA degree from Zagreb University, Faculty of Economics and Business in 2009, and enrolled in Postgraduate Doctoral Study in Information Sciences at FOI in 2017.

Bibliography and active participation in conferences:

1. Jurčić, Marina; Strahonja, Vjeran

Conceptual Analysis of the Digital Innovation Hub as a Value Delivery System. // Central European Conference on Information and Intelligent Systems CECIIS 2020 / Strahonja, Vjeran; Steingartner, William; Kirinić, Valentina (ur.). Varaždin: University of Zagreb, Faculty of Organization and Informatics Varaždin, 2020. str. 143-150. (<https://www.bib.irb.hr/1184979>) (ostalo, međunarodna recenzija, cjeloviti rad (in extenso), znanstveni)

2. Jurčić, Marina; Lovrenčić, Sandra; Kurnoga, Nataša

Croatian Defense Industry Competitiveness Cluster: Knowledge Management and Innovation Perspective. // Business systems research, 11 (2020), 1; 59-72 doi:10.2478/bsrj-2020-0005 (međunarodna recenzija, članak, znanstveni)

“No Grit, No Pearl”